



AKKO®

Değiştirilebilir Uçlu Takımlar, Takım Tutucu Sistemler ve Kesici Uçlar
Indexable Tools, Tool Holder Systems and Cutting Inserts
Zerspanungswerkzeuge, Werkzeugaufnahmen und Zerspanungswerkzeuge



2024

KESİCİ UÇ KATALOĞU

INSERT CATALOGUE

WENDESCHNEIDPLATTE KATALOG

versiyon • version • auflage ▶ 0100/0924



www.akko.com.tr

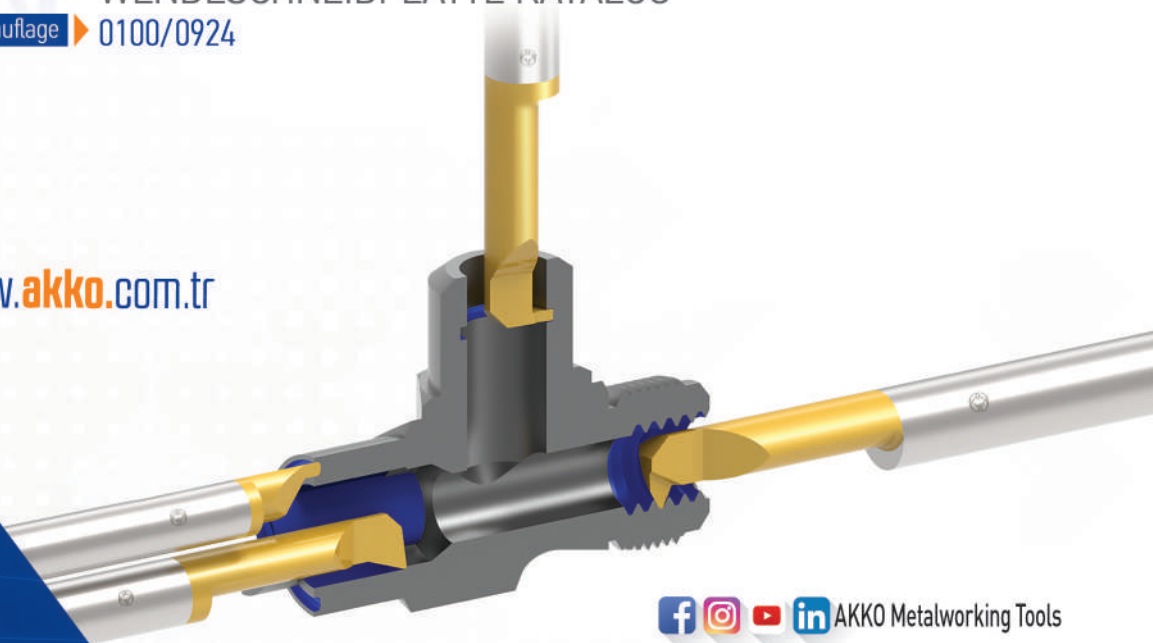



TS EN ISO 9001:2015

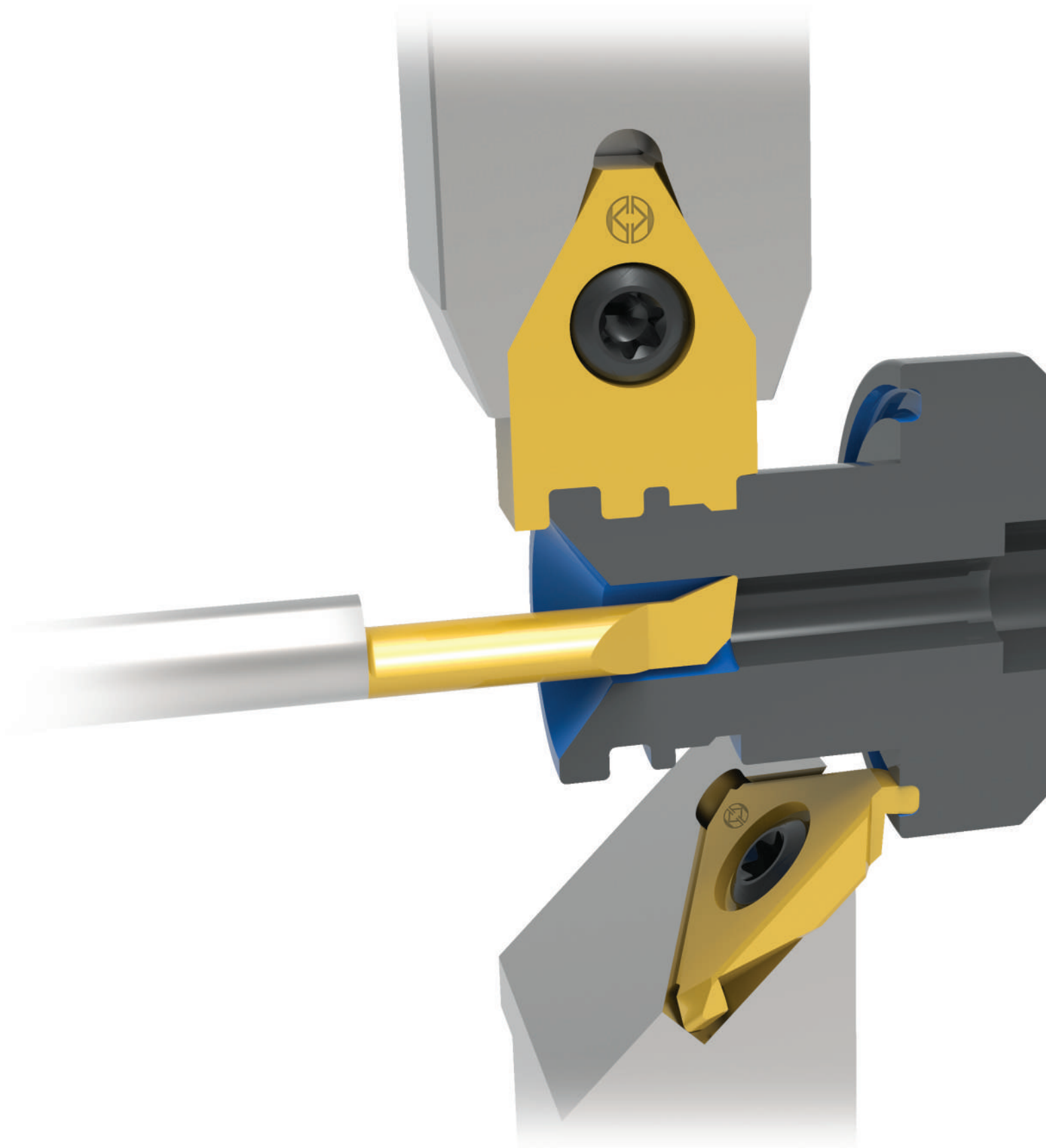

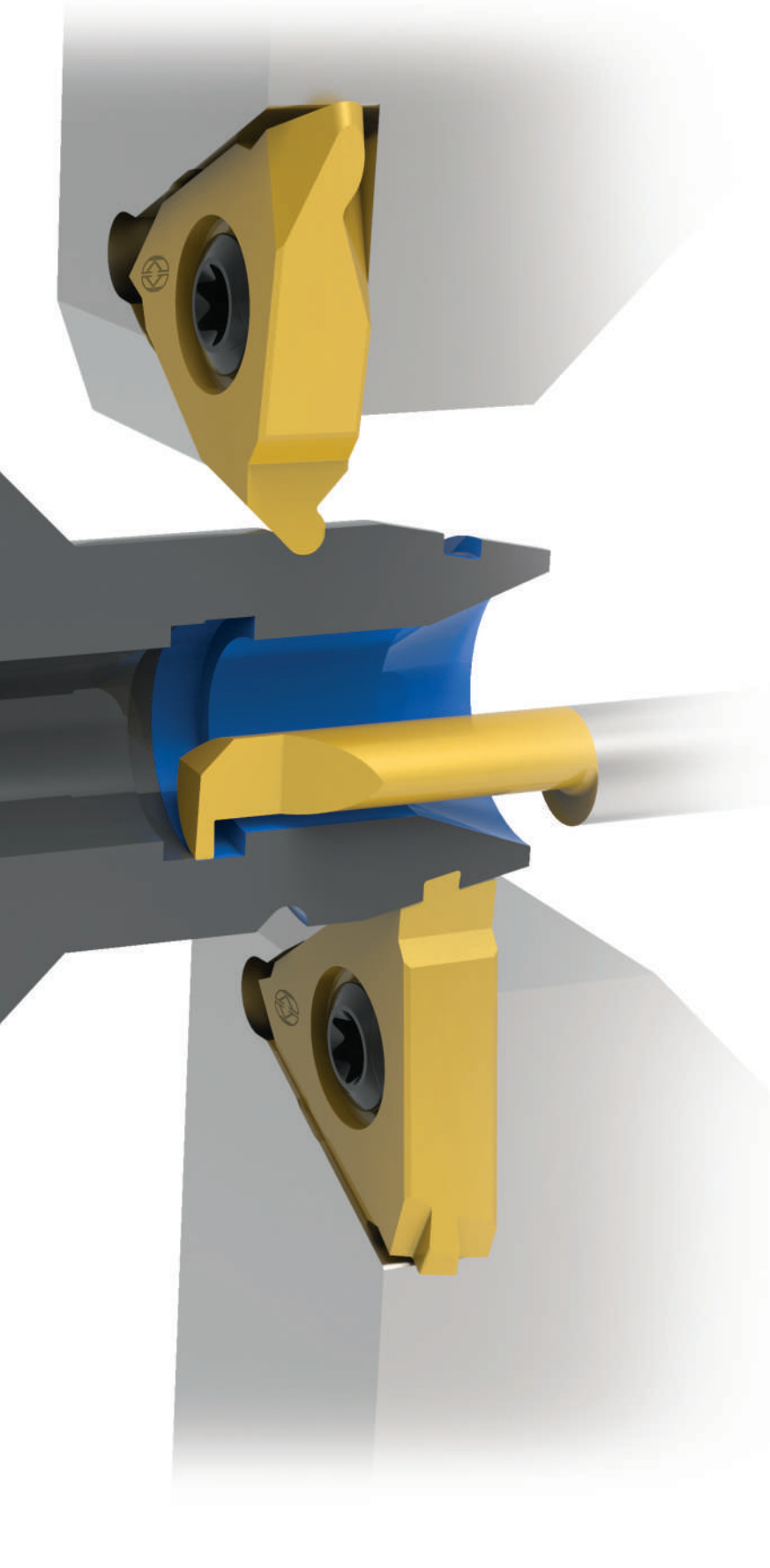

1986 yılında Abdullah KARAKUŞ tarafından kurulan AKKO Makina Sanayi ve Ticaret A.Ş. Tornalama Takımları, Diş ve Kanal Açma Takımları, Delik Delme Takımları, Frezeleme Takımları ve talebe yönelik Özel Takımlar, Monoblok ve Tutucular ile Profil Uçlar üretmektedir. Şu an 40.000m²'ye yakın bir alanda Türkiye, Japonya, Almanya, İsviçre gibi ülkelerin ürettikleri son teknoloji tezgah ve ekipmanlarıyla yıllık 750.000 adet üretim kapasitesiyle, standart 10.000 çeşit takım üretimi ve 70.000 adet profil uç üretimi yapmaktadır. Avrupa, Asya, Afrika, Güney Amerika, Kuzey Amerika ve Orta Doğu kıtalarında şimdilik düzenli olarak 90 ülkeye ürün sevkiyatına devam etmektedir. Minimum 300.000 adet üretilmiş ürün stoklarında mevcut bulunmaktadır. Firma için özel üretilen çelik hammadde işleme girer ve bütün üretim süreci kendi bünyesinde gerçekleşmektedir. Çeliğin işlenmesi, ısıl işlemi, üzerindeki kaplama ve her türlü üretim operasyonları bir entegre tesis olan AKKO'da yapılmaktadır.

We as AKKO Makina Sanayi ve Ticaret A.Ş. which were founded by Abdullah KARAKUŞ in 1986, produce Turning Tool Holders, Threading and Grooving Tool Holders, U-Drills, Milling Tool Holders, Precision Tool Holders (OEM Tool Holders) on-demand, Monoblocks and Holders, and Profile Inserts. We produce a standard 10.000 kinds of tool holders with a production capacity of 750.000 pieces and 70.000 pieces of special profile inserts per year in an area of about 40.000 square meters. We are going on regularly exporting to 90 countries including European, Asian, African, South American Countries, North American Countries, and Middle Eastern countries. We keep ready about 300.000 pieces produced products in our stock. Steel Raw materials that we make produced especially for us are delivered our factory and all production process are made in our factory. All kinds of operations from machining of steel to heat treatment and coating on our tools are made in our integrated factory AKKO.

Wir die Firma AKKO Makina Sanayi ve Ticaret A.Ş. welches durch Herrn Abdullah Karakuş in 1986 gegründet wurde, produzieren Dreh-, Gewinde- und Stechwerkzeuge für Wendeschneidplatten. Zum Lieferprogramm gehören außerdem Wendeplattenbohrer, Wendeplattenfräser, Halter und auf Anfrage auch Sonderwerkzeuge für Wendeschneidplatten. Alle Werkzeuge sind auch als OEM-Version lieferbar. Wir produzieren 10.000 Standard Arten der Werkzeughalter mit einer Produktionskapazität von 750.000 Stücken und 70.000 Stück Spezialprofileinlagen per annum auf einer Fläche von 40.000 Quadrat Meter. Wir exportieren unsere eigenproduzierten Ware nach 90 Ländern, Europa, Asien, Afrika, Süd amerikanische Länder, Mittlerer Osten. Lieferbereit halten wir 300.000 Stück produzierte Produkte auf Lager. Das eingesetzte Rohmaterial wird speziell für unsere Firma produziert. Alle Produktionsschritte werden auf unseren eigenen Anlagen veranlasst. Alle einzelnen Produktionsschritte wie z.B. mechanische Bearbeitung, Wärmebehandlung und Beschichtung unserer Werkzeuge erfolgen auf unseren eigenen Maschinenanlagen.

S8-S13 S8-S13 S8-S13	POLY-V KAYIŞ KASNAK KANAL AÇMA UÇLARI VE TAKIMLARI TEK KANALLI POLY-V UÇLARI VE TAKIMLARI ÇİFT KANALLI POLY-V UÇLARI VE TAKIMLARI ÇOK KANALLI POLY-V UÇLARI VE TAKIMLARI
S14-S17 S14-S17 S14-S17	KANAL AÇMA, YÜZEY KANAL AÇMA UÇLARI VE TAKIMLARI YÜZEY KANAL AÇMA UÇLARI VE TAKIMLARI RADYUSLU KÖŞE BOŞALTMA UÇLARI VE TAKIMLARI ÖZEL KANAL UCU BİLGİ ALMA FORMU
S18	POLYGON FREZELEME UÇLARI ve TAKIMLARI
S19	NÖTR PROFİL KANAL AÇMA TAKIMLARI
S24-S27	MİCO CUT UÇLARI VE TAKIMLAR
S28-S37	MİMİLL UÇLARI VE TAKIMLARI
S38-S41 S38-S41	SEGMAN UÇLARI VE TAKIMLARI SEGMAN UÇLARI (DIN471) VE TAKIMLARI ÖZEL PROFİL SEGMAN UÇLARI BİLGİ ALMA FORMU
S42-S49 S42-S49 S42-S49 S42-S49	BROŞ ÇEKME (KAMA) UÇLARI VE TAKIMLARI BROŞ ÇEKME TAKIMLARI BROŞ ÇEKME (KAMA) UÇLARI KAMA KANALI PAH KIRMA UÇLARI ÖZEL PROFİL BROŞ UCU BİLGİ ALMA FORMU
S56-S59 S56-S59 S56-S59	WHIRLING UÇLARI VE TAKIMLARI WHIRLING TAKIMLARI (RING) WHIRLING UÇLARI WHIRLING UÇLAR BİLGİ ALMA FORMU
S60-S75 S60-S75 S60-S75 S60-S75 S60-S75 S60-S75 S60-S75	MİNİ CUT TAKIMLAR MINİ CUT TUTUCULAR DELİK İÇİ MİNİ CUT TAKIMLAR TERS TÖRNALAMA MİNİ CUT TAKIMLAR KANAL AÇMA MİNİ CUT TAKIMLAR DİŞ ÇEKME MİNİ CUT TAKIMLAR ALIN KANALI AÇMA TAKIMLARI ÖZEL PROFİL MİNİ CUT TAKIMLAR BİLGİ ALMA FORMU
S76-S79 S76-S79 S76-S79 S76-S79 S76-S79	TORX – ALYAN / PUNCH - KAZIMA TAKIMLARI DÖNER BROŞ AÇMA TAKIMLARI TORX PUNCH TAKIMLARI ALYAN PUNCH TAKIMLARI TORX KAZIMA TAKIMLARI ALYAN KAZIMA TAKIMLARI
S80-S85	S-DRILL TAKMA UÇLU MATKAP TAKIMLARI VE UÇLARI S-DRILL TAKIMLARI VE UÇLARI
S86-S97 S86-S97	DİŞ AÇMA UÇLARI VE TAKIMLARI DİŞ AÇMA FREZELEME TAKIMLARI VE UÇLARI DİŞ UCU ÖZEL PROFİL BİLGİ ALMA FORMU
S98-S107	ÖZEL ÇÖZÜMLER
S108-114 S108-114 S108-114 S108-114	SUPAP YUVASI İŞLEME UÇLARI VE TAKIMLARI SUPAP YUVASI İŞLEME TAKIMLARI SUPAP YUVASI İŞLEME UÇLARI SUPAP YUVASI İŞLEME ÖZEL UÇ BİLGİ ALMA FORMU PİLOT MİLLER
S116-S146 S116-S146 S116-S146	ISO UÇLAR WCMX/SPMX UÇLAR KESME VE KANAL AÇMA UÇLARI AYARLANABİLİR BARA UÇLARI

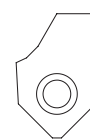
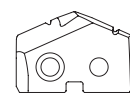
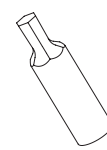
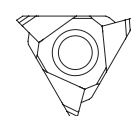
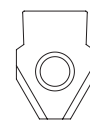
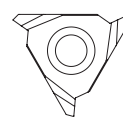
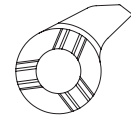
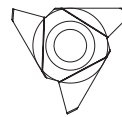
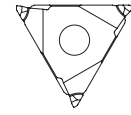
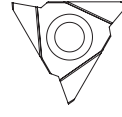

İÇİNDEKİLER

CONTENTS

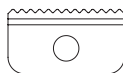
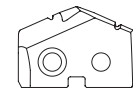
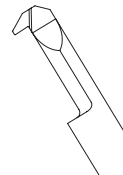
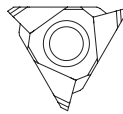
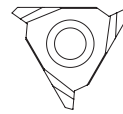
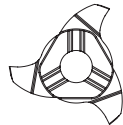
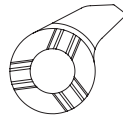
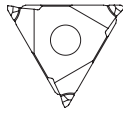
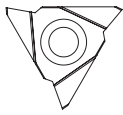

POLY-V BELT PULLEY GROOVING INSERTS AND TOOLHOLDERS	
INSERTS FOR GROOVING SINGLE V-RIBBED PULLEYS	P8-P13
INSERTS FOR GROOVING DOUBLE V-RIBBED PULLEYS	P8-P13
INSERTS FOR GROOVING MULTI V-RIBBED PULLEYS	P8-P13
GROOVING, FACE GROOVING INSERTS AND TOOLHOLDERS	
FACE GROOVING INSERTS AND TOOLHOLDERS	P14-P17
INSERTS AND TOOLHOLDERS FOR GROOVING CORNER RELIEFS WITH RADIUS	P14-P17
INFORMATION FORM FOR SPECIAL GROOVING INSERTS	P14-P17
POLYGON MILLING TOOLS AND INSERTS	P18
NEUTRAL PROFILE GROOVING TOOLS	P19
MICO CUT INSERT AND TOOLS	P24-P27
MIMILL INSERTS AND TOOLS	P28-P37
RING INSERTS AND TOOLHOLDERS	
RING INSERTS (DIN471) AND TOOLHOLDERS	P38-P41
SPECIAL PROFILE RING INSERTS INFORMATION FORM	P38-P41
BROACHING (KEYWAY) INSERTS AND TOOLHOLDERS	
BROACHING TOOLHOLDERS	P42-P49
BROACHING (KEYWAY) INSERTS	P42-P49
INSERTS FOR KEYWAY CHAMFERING	P42-P49
INFORMATION FORM FOR SPECIAL PROFILE BROACHING INSERTS	P42-P49
WHIRLING INSERTS AND TOOLHOLDERS	
WHIRLING TOOLHOLDERS (RING)	P56-P59
WHIRLING INSERTS	P56-P59
INFORMATION FORM FOR WHIRLING INSERTS	P56-P59
MINI CUT TOOLHOLDERS	
MINI CUT HOLDERS	P60-P75
INTERNAL MINI CUT TOOLS	P60-P75
MINI CUT BACK BORING	P60-P75
GROOVING MINI CUT TOOLS	P60-P75
THREADING MINI CUT TOOLS	P60-P75
MINI CUT FACE GROOVING TOOLS	P60-P75
INFORMATION FORM FOR SPECIAL PROFILE MINI CUT TOOLS	P60-P75
TORX - ALLEN / PUNCH - BROACH SET	
ROTARY BROACH TOOL HOLDER	P76-P79
TORX PUNCH	P76-P79
ALLEN PUNCH	P76-P79
TORX BROACH	P76-P79
ALLEN BROACH	P76-P79
INDEXABLE S-DRILLS AND INSERTS	
INDEXABLE S-DRILL TOOLHOLDER AND INSERTS	P80-P85
THREADING INSERTS AND TOOLS	
THREAD MILLING INSERTS AND TOOLHOLDER	P86-P97
INFORMATION FORM FORE SPECIAL PROFILE THREADING INSERT	P86-P97
SPECIAL SOLUTIONS	P98-P107
VALVE SEAT INSERTS AND TOOLHOLDERS	
VALVE SEAT TOOLHOLDERS	P108-114
VALVE SEAT INSERTS	P108-114
INFORMATION FORM FOR VALVE SEAT INSERTS	P108-114
CARBIDE PILOT FOR VALVE SEAT	P108-114
ISO INSERTS	
WCMX-SPMX INSERTS	P116-P146
GROOVING & PARTING INSERT	P116-P146
ADJUSTABLE BORING INSERT	P116-P146

P8-P13 P8-P13 P8-P13	WENDESCHNEIDPLATTEN UND WERKZEUGE FÜR POLY-V RIEMENSCHLEIBEN WENDESCHNEIDPLATTEN UND WERKZEUGE ZUM NUTEN VON KEILRIPPENSCHLEIBEN WENDESCHNEIDPLATTEN UND WERKZEUGE ZUM NUTEN VON DUAL KEILRIPPENSCHLEIBEN WENDESCHNEIDPLATTEN UND WERKZEUGE ZUM NUTEN VON MULTI KEILRIPPENSCHLEIBEN
P14-P17 P14-P17 P14-P17	WENDESCHNEIDPLATTEN UND WERKZEUGE FÜR NUTEN UND OBERFLÄCHENNUTEN WENDESCHNEIDPLATTEN UND WERKZEUGE FÜR OBERFLÄCHENNUTEN WENDESCHNEIDPLATTEN UND WERKZEUGE FÜR AXIAL FREISTICHE INFORMATIONSFORM FÜR SONDER WENDESCHNEIDPLATTEN
P18	WENDESCHNEIDPLATTEN UND WERKZEUGE FÜR POLYGON
P19	NEUTRAL PROFILE GROOVING TOOLS
P24-P27	MICO CUT WENDESCHNEIDPLATTEN WERKZEUGE
P28-P37	MIMILL WENDESCHNEIDPLATTEN WERKZEUGE
P38-P41 P38-P41	RINGPLATTEN UND WERKZEUGE RINGPLATTEN WERKZEUGE UND RINGPLATTEN (DIN471) INFORMATIONSFORM FÜR SONDERRINGPLATTEN
P42-P49 P42-P49 P42-P49 P42-P49	WENDESCHNEIDPLATTEN UND WERKZEUGHALTER FÜR DIE NUTBEARBEITUNG WERKZEUGHALTER FÜR DIE NUTBEARBEITUNG WENDESCHNEIDPLATTEN FÜR DIE NUTBEARBEITUNG WENDESCHNEIDPLATTEN FÜR KEILNUTTUNGSBEARBEITUNGEN INFORMATIONSFORMULAR FÜR SONDER WENDESCHNEIDPLATTEN ZUR NUTTUNGSBEARBEITUNGEN
P56-P59 P56-P59 P56-P59	WENDESCHNEIDPLATTEN UND WERKZEUGHALTER ZUM GEWINDEWIRBELN GEWINDEWIRBEL (RING) GEWINDEWIRBEL FÜR INFORMATIONSFROM FÜR GEWINDEWIRBEL
P60-P75 P60-P75 P60-P75 P60-P75 P60-P75 P60-P75 P60-P75 P60-P75	MINI CUT WERKZEUGE MINI CUT HALTER MINI CUT WERKZEUGE FÜR INNENBOHRUNG MINI CUT ZURÜCK BOHRUNGE MINI CUT WERKZEUGE FÜR NUTEN GEWINDE MINI CUT WERKZEUGE WENDESCHNEIDPLATTEN INFORMATOINSFORM FÜR SONDERPROFIL MINI CUT WERKZEUGE
P76-P79 P76-P79 P76-P79 P76-P79 P76-P79	WINKELSCHRAUBENDREHER / EINSATZRING SET HALTER FÜR ROTATIONSRAUMWERKZEUGE TORX STANZWERKZEUGE WINKELSCHRAUBENDREHER WERKZEUGE SCHRAUBENRING WINKELSCHRAUBENDREHERRING
P80-P85	S-SYSTEM VOLLBOHRER/BEZEICHNUNGSSYSTEM FÜR VOLLBOHRER S-SYSTEM BOHRSPITZEN UND WERKZEUGE
P86-P97 P86-P97	GEWINDESCHNEIDPLATTEN UND WERKZEUGE GEWINDEFÄSERWERKZEUGE INFORMATIONSFROMULAR FÜR SONDER GEWINDEPLATTEN
P98-P107	SONDERLÖSUNGEN
P108-114 P108-114 P108-114 P108-114	WENDESCHNEIDPLATTEN UND WERKZEUGE FÜR VENTILSITZE WENDESCHNEIDPLATTEN FÜR VENTILSITZE BOHRUNGSPITZEN FÜR VENTILSITZ BEARBEITUNG INFORMATIONSFORM FÜR SONDER VENTILSITZ BEARBEITUNG METALLSCHAFT FÜR VENTILSITZ
P116-P146 P116-P146 P116-P146	ISO WENDESCHNEIDPLATTE WCMX-SPMX WENDESCHNEIDPLATTE AUSSTECH UND EINSTECHWENDESCHNEIDPLATTEN EINSTELLBARE WENDESCHNEIDPLATTEN FÜR SPINDELKÖPFE

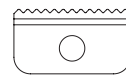
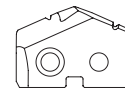
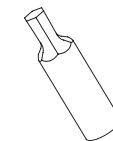
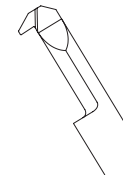
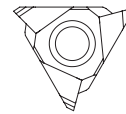
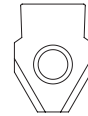
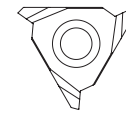
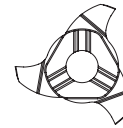
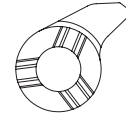
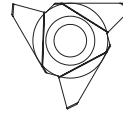
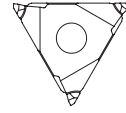
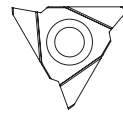

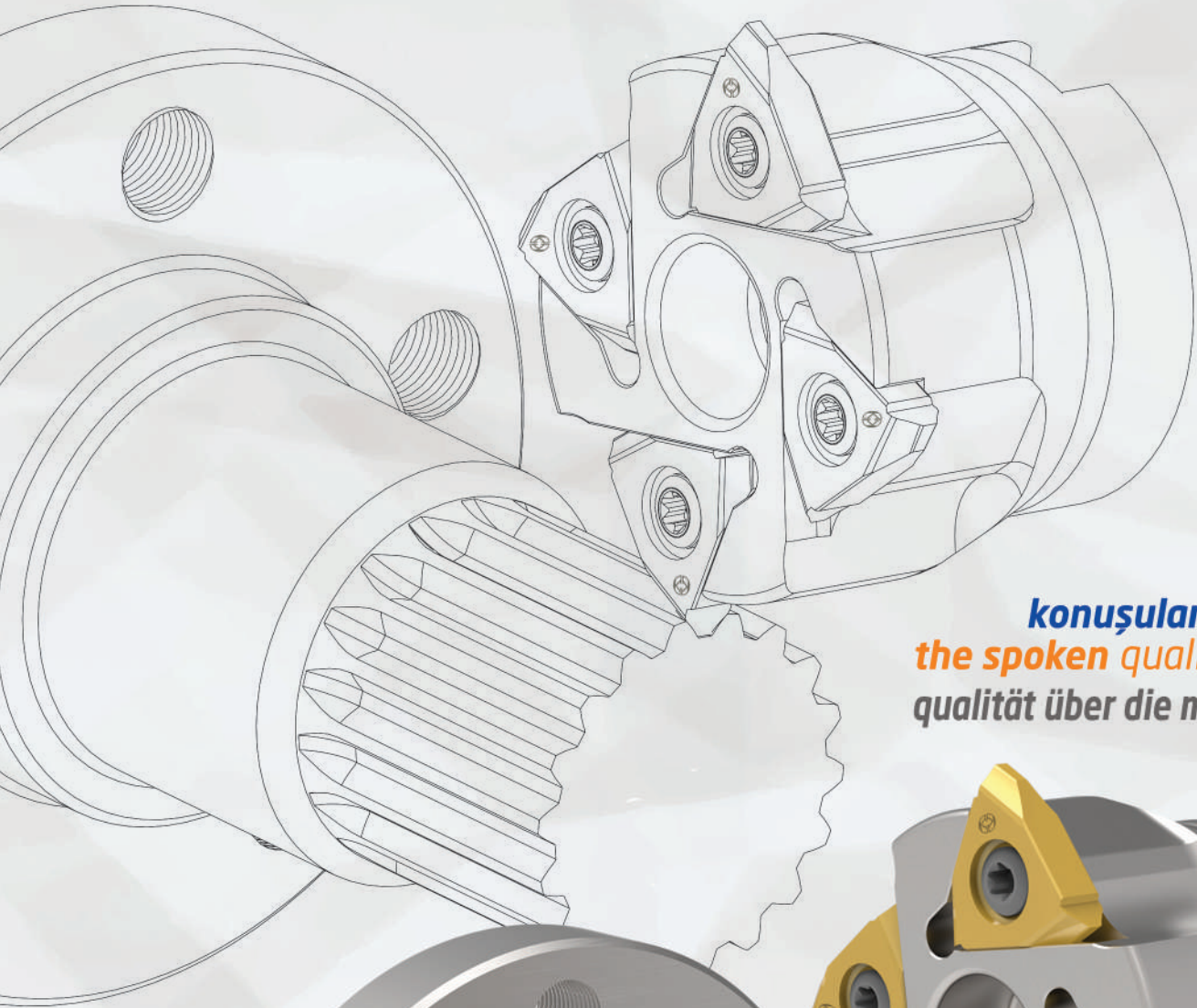

konusulan kalite...
the spoken quality...
qualität über die man spricht...

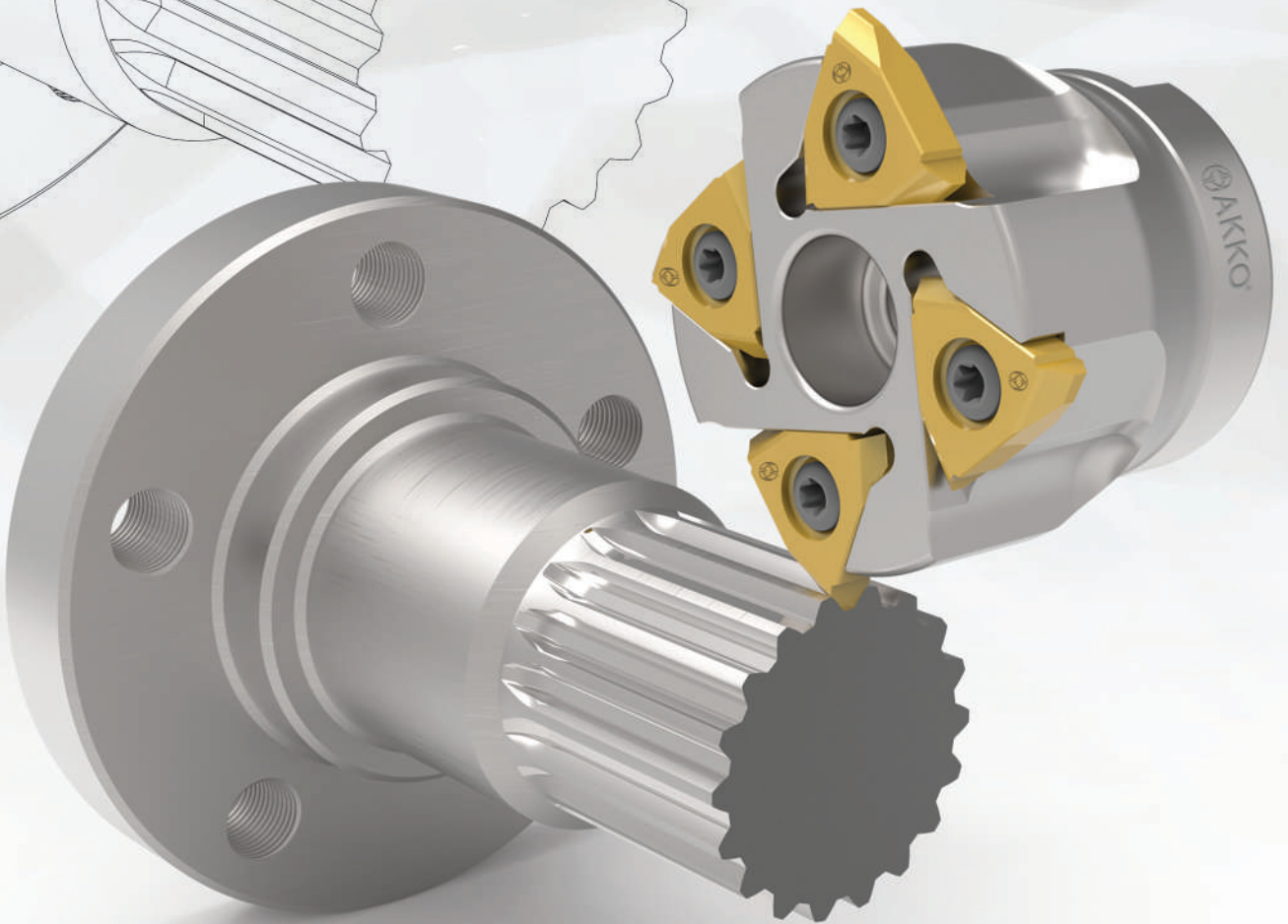

POLY-V

KAYIŞ KASNAK KANAL AÇMA UÇLARI VE TAKIMLARI
POLY-V BELT PULLEY GROOVING INSERTS AND TOOLHOLDERS
WENDESCHNEIDPLATTEN UND WERKZEUGE FÜR
POLY-V RIEMENSCHLEIBEN



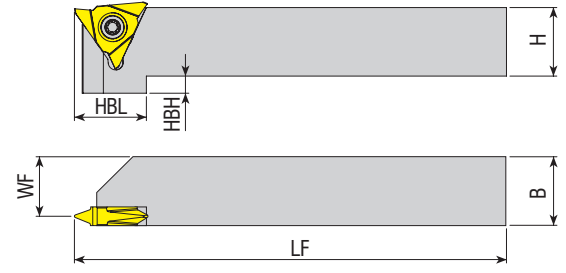

Takım Kodu Ordering Code Bestell-Bezeichnung	Stok Stock Lager		Takım Ölçüleri (mm) Dimension (mm) Abmessung (mm)					Kesici Uç Insert Wendeschneidplatte	Yedek Parçaları / Spare Parts / Ersatzteile		
	R	L	H	B	WF	LF	HBL		HBH	Sıkma Vidası Screw Schraube	Tork Anahtar Torx Key Torx-Schlüssel
ADKT-T12P-R/L-1616-T5	●	●	16	16	13.50	125	21	5	T12...	1020-M5x14	80-T20
ADKT-T12P-R/L-2020-T5	●	●	20	20	17.50	125	21	5			
ADKT-T12P-R/L-2525-T5	●	●	25	25	22.50	150	-	-			
ADKT-T12P-R/L-3232-T5	●	●	32	32	29.50	170	-	-			

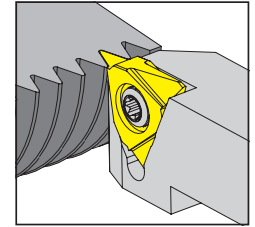
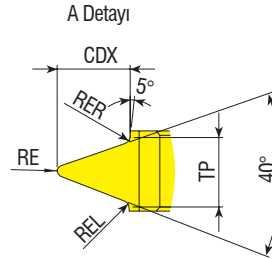
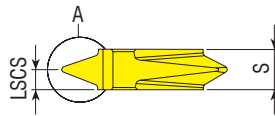
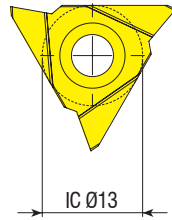
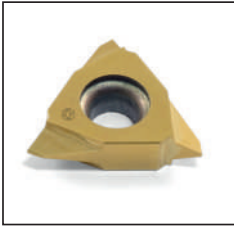

Uç Kodu Insert Code Wendeplatten-Bezeichnung	Stok Stock Lager		Uç Ölçüleri (mm) Insert Dimension (mm) Abmessung (mm)							Kalite Grade Sorte
	R	L	DIN/ISO KODU	TP	S	RE	RER / REL	LSCS	CDX	
T12.10.0234.PJ.R/L	●	●	PJ	2.34	5.20	0.36	0.24	2.60	2.08	VK20F01
T12.10.0356.PK.R/L	●	●	PK	3.56	5.20	0.44	0.35	2.60	3.40	VK20F01
T12.10.0470.PL.R/L	●	●	PL	4.70	5.20	0.36	0.45	2.60	4.90	VK20F01

R: Sağ / Right / Rechts L: Sol / Left / Links

● Stokta / In Stock / Auf Lager ○ Stokta Yok / Non Stock Item / Kein Lagerartikel, Lieferzeit auf Anfrage

ADKT-T12P... Tipi katepler ile kullanınız. / Use with ADKT-T12P... Type toolholder. / Einsatz mit ADKT-T12P...-Werkzeughalter



İndekslemede boy $\pm 0,02$ mm / Indexability length $\pm 0,02$ mm / Wiederholgenauigkeit Länge $\pm 0,02$ mm

Diğer ölçü talepleriniz için müşteri temsilciniz ile irtibata geçiniz. / For other dimension request, contact with customer representative. / Für weitere Abmessungen kontaktieren Sie bitte den Vertrieb.

Sipariş Örneği/Ordering Example/Bestellbeispiel

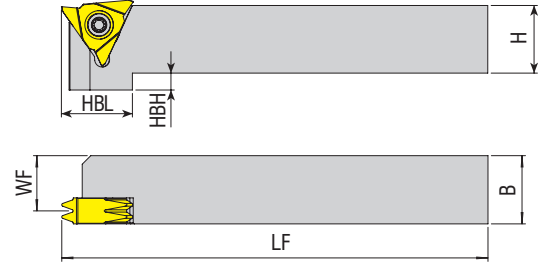
1 ad./pcs./stück ADKT-T12P-R-1616-T5

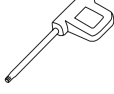

Takım Kodu Ordering Code Bestell-Bezeichnung	Stok Stock Lager		Takım Ölçüleri (mm) Dimension (mm) Abmessung (mm)					Kesici Uç Insert Wendeschnidplatte	Yedek Parçaları / Spare Parts / Ersatzteile		
	R	L	H	B	WF	LF	HBL		HBH	Sıkma Vidası Screw Schraube	Tork Anahtar Torx Key Torx-Schlüssel
ADKT-T30P-R-1616-3.56	●	●	16	16	12.2	125	20	5	 T30... T12...	 1020x M4.5 X14	 80-T20
ADKT-T12P-R-1616-2.34	●	●	16	16	12.2	125	20	5			
ADKT-T30P-R-2020-3.56	●	●	20	20	16.2	125	20	3			
ADKT-T12P-R-2020-2.34	●	●	20	20	16.2	125	20	3			
ADKT-T30P-R-2525-3.56	●	●	25	25	21.2	150	-	-			
ADKT-T12P-R-2525-2.34	●	●	25	25	21.2	150	-	-			
ADKT-T30P-R-3232-3.56	●	●	32	32	28.2	170	-	-			
ADKT-T12P-R-3232-2.34	●	●	32	32	28.2	170	-	-			

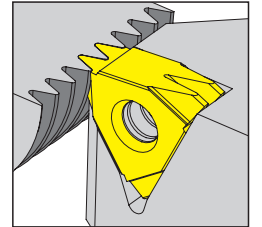
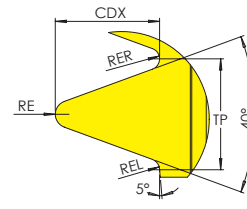
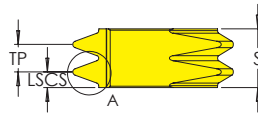
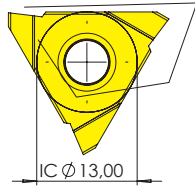

Uç Kodu Insert Code Wendeplatten-Bezeichnung	Stok Stock Lager	Uç Ölçüleri (mm) Insert Dimension (mm) Abmessung (mm)							Kalite Grade Sorte
		DIN/ISO KODU	TP	S	RER/REL	RE	LSCS	CDX	
T12.07.0234.PJ.x2	●	PJ	2.34	5.20	0.24	0.36	1.48	2.08	VK20F01
T30.07.0356.PK.x2	●	PK	3.56	7.60	0.35	0.45	2.60	3.40	VK20F01

R: Sağ / Right / Rechts L: Sol / Left / Links
● Stokta / In Stock / Auf Lager ○ Stokta Yok / Non Stock Item / Kein Lagerartikel, Lieferzeit auf Anfrage

Sipariş Örneği/Ordering Example/Bestellbeispiel
1 ad./pcs./stück ADKT-T30P-R-1616-3.56

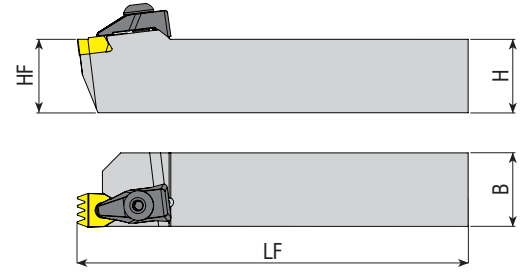

Takım Kodu Ordering Code Bestell-Bezeichnung	Stok Stock Lager		Takım Ölçüleri (mm) Dimension (mm) Abmessung (mm)			Kesici Uç Insert Wendeschneidplatte	Baskı Pabucu Wedge Clamp Spannpratze	Pabuç Vidası Clamp Screw Schraube	Anahtar Allen Key Innensechskantschlüssel
	R	L	HF=H	B	LF				
ATPVK 2020 K2.34X4	○	○	20	20	125	B26.07.0234PJ.x4	ATK-04	AKV-19-M7X25	AAL-05-4
ATPVK 2525 M2.34X4	○	○	25	25	150				
ATPVK 3232 P2.34X4	●	○	32	32	170				
ATPVK 2020 K3.56X4	○	○	20	20	125	B26.07.0356PK.x4	ATK-04	AKV-19-M7X25	AAL-05-4
ATPVK 2525 M3.56X4	○	○	25	25	150				
ATPVK 3232 P3.56X4	●	○	32	32	170				
ATPVK 2020 K4.7X3	○	○	20	20	125	B26.07.0470PL.x3	ATK-04	AKV-19-M7X25	AAL-05-4
ATPVK 2525 M4.7X3	○	○	25	25	150				
ATPVK 3232 P4.7X3	●	○	32	32	170				

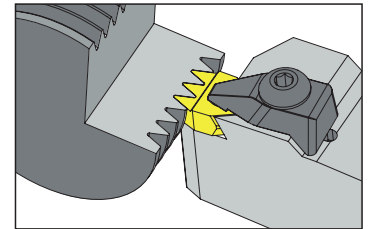
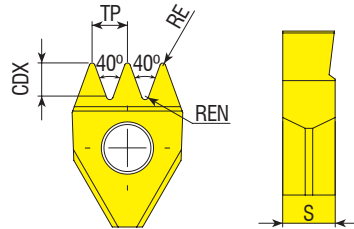
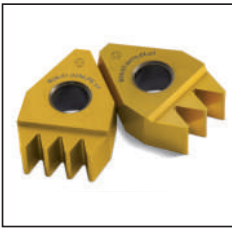

Uç Kodu Insert Code Wendepplatten-Bezeichnung	Stok Stock Lager	Uç Ölçüleri (mm) Insert Dimension (mm) Abmessung (mm)					Kalite Grade Sorte	
		DIN/ISO KODU	TP	S	RE	REN		CDX
B26.07.0234.PJx4	●	PJ	2.34	7	0.36	0.24	2.05	VK10F01
B26.07.0356.PKx3	●	PK	3.56	7	0.45	0.35	3.35	VK10F01
B26.07.0356.PKx4	●	PK	3.56	7	0.45	0.35	3.35	VK10F01
B26.07.0470.PLx3	●	PL	4.70	7	0.38	0.45	4.85	VK10F01

R: Sağ / Right / Rechts L: Sol / Left / Links
● Stokta / In Stock / Auf Lager ○ Stokta Yok / Non Stock Item / Kein Lagerartikel, Lieferzeit auf Anfrage

Sipariş Örneği/Ordering Example/Bestellbeispiel
1 ad./pcs./stück ATPVK 2020 K2.34X4

POLY-V ÖZEL ÇÖZÜMLER
POLY-V SPECIAL SOLUTIONS
POLY-V SPEZIELLE LÖSUNGEN



PM Kasnak Çözümleri
PM Pulley Solutions **PM Reimenscheiben Lösungen**

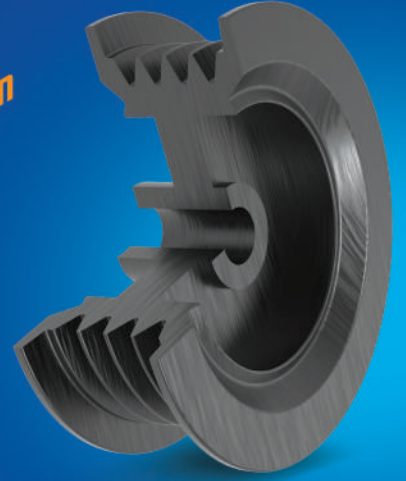

PH Kasnak Çözümleri
PH Pulley Solutions **PH Reimenscheiben Lösungen**



PK Kasnak Çözümleri
PK Pulley Solutions **PK Reimenscheiben Lösungen**

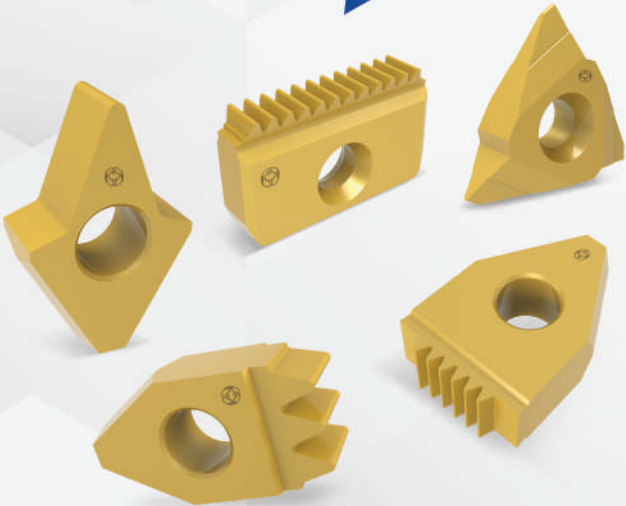



 **AKKO®**

www.akko.com.tr

KANAL AÇMA

KANAL AÇMA, KÖŞE BOŞALTMA UÇLARI ve TAKIMLARI
INSERTS and TOOLHOLDERS FOR GROOVING CORNER RELIEFS
WENDESCHNEIDPLATTEN UND WERKZEUGE FÜR
AXIAL FREISTICHE



www.akko.com.tr

Yenilikler için bizi takip edin.
Follow us for news.
Für Neuheiten bitte uns folgen.

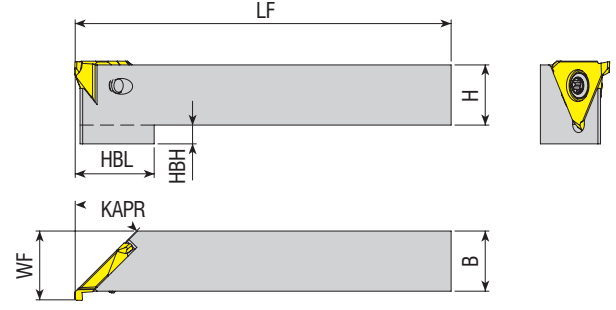

Takım Kodu Ordering Code Bestell-Bezeichnung	Stok Stock Lager		Takım Ölçüleri (mm) Dimension (mm) Abmessung (mm)						Kesici Uç Insert Wendeschnidplatte	Yedek Parçaları / Spare Parts / Ersatzteile		
	R	L	H	B	WF	LF	HBL	HBH		KAPR	Sıkma Vidası Screw Schraube	Tork Anahtar Torx Key Torx-Schlüssel
AAUT-T20-R/L-1616-45	●	●	16	16	18.3	125	21	5	45°	T20...	1020-M5x7.5	80-T20
AAUT-T20-R/L-2020-45	●	●	20	20	22.3	125	21	5	45°			
AAUT-T20-R/L-2525-45	●	●	25	25	27.3	150	-	-	45°			

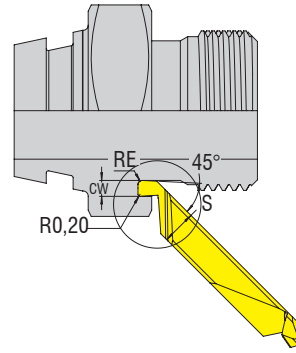
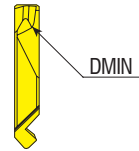
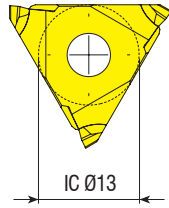
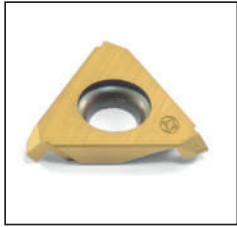

Sağ versiyon gösterilmiştir
 Right hand version shown
 Abbildung zeigt rechte Ausführung

Uç Kodu Insert Code Wendeplatten-Bezeichnung	Stok Stock Lager		Uç Ölçüleri (mm) Insert Dimension (mm) Abmessung (mm)					Kalite Grade Sorte	Minimum Çap Ø Minimum Diameter Ø Kleinsten Durchmesser ø	Kanal Derinliği Depth of Groove Up to Stechtiefe bis zu	Kanal Genişliği Width of Groove Stechbreite
	R	L	CW	S	RE	CDX	DMIN				
T20.00.0815.45.04R/L	●	●	1.5	3.25	0.4	1.6	8	VK20F01	8	1.6	1.5
T20.00.1220.45.05R/L	●	●	2.0	3.25	0.5	1.8	12	VK20F01	12	1.8	2.0
T20.00.2024.45.06R/L	●	●	2.4	3.25	0.6	2.0	20	VK20F01	20	2.0	2.4

AAUT. Tipi katerlerle kullanınız. / Use with AAUT type toolholder. / Einsatz mit AAUT-Werkzeughalter
 Kullanım öncesinde dip boşluk işlenmiş olmalıdır. / The undercut must be placed before axial machining. / Der Freistich muss vor der Axialbearbeitung gefertigt werden
 İndekslenliğinde boy ±0.02mm / Indexability length ±0.02mm / Wiederholgenauigkeit Länge ± 0,02 mm

Sipariş Örneği/Ordering Example/Bestellbeispiel
 1 ad./pcs./stück AAUT-T20-R/L-1616-45

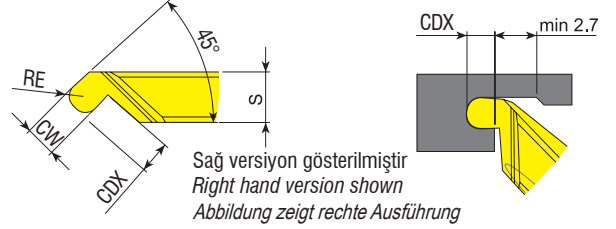
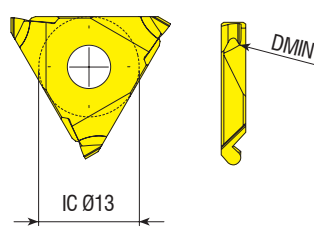

Sağ versiyon gösterilmiştir
 Right hand version shown
 Abbildung zeigt rechte Ausführung

Uç Kodu Insert Code Wendepplatten-Bezeichnung	Stok Stock Lager		Uç Ölçüleri (mm) Insert Dimension (mm) Abmessung (mm)					Kalite Grade Sorte	Minimum Çap Ø Minimum Diameter Ø Kleinstes Durchmesser ø	Kanal Derinliği Depth of Groove Up to Stechtiefe bis zu	Kanal Genişliği Width of Groove Stechbreite
	R	L	CW	S	RE	CDX	DMIN				
T20.00.1220.45.10R/L	●	●	2.0	3.25	1.0	1.8	12	VK20F01	12	1.8	2

AAUT. Tipi katerlerle kullanınız. / Use with AAUT type toolholder. / Einsatz mit AAUT-Werkzeughalter
 Kullanım öncesinde dip boşluk işlenmiş olmalıdır. / The undercut must be placed before axial machining. / Der Freistich muss vor der Axialbearbeitung gefertigt werden
 İndekslediğinde boy $\pm 0.02\text{mm}$ / Indexability length $\pm 0.02\text{mm}$ / Wiederholgenauigkeit Länge $\pm 0,02\text{ mm}$

R: Sağ / Right / Rechts L: Sol / Left / Links

● Stokta / In Stock / Auf Lager ○ Stokta Yok / Non Stock Item / Kein Lagerartikel, Lieferzeit auf Anfrage

Sipariş Örneği/Ordering Example/Bestellbeispiel
 1 ad./pcs./stück T20.00.1220.45.10R/L

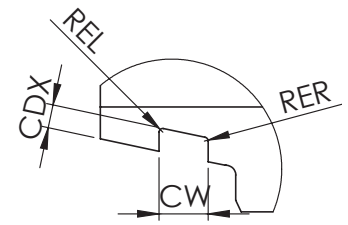
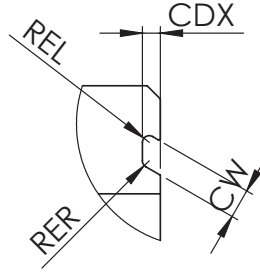
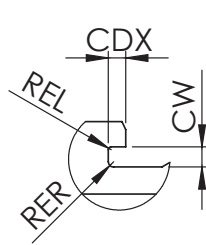
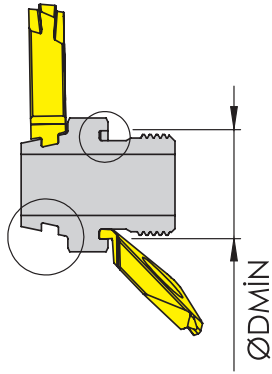

ÖZEL KANAL UCU BİLGİ ALMA FORMU
 INFORMATION FORM FOR SPECIAL GROOVING INSERTS
 INFORMATIONSFORM FÜR SONDER WENDESCHNEIDPLATTEN

CW	CDX	RER	REL	DMIN	İŞPARÇASI MALZEMESİ / WORKPIECE MATERIAL/ WERKSTÜCKMATERIAL

Farklı özel profilleri için lütfen irtibata geçiniz. / Please contact for different special profiles. / Bitte kontaktieren Sie uns für Sonderwendeschneidplatten

export@akko.com.tr adresine teknik resim göndermeniz halinde iş parçanıza özel tasarımlar yapılabilir. / If you send a technical drawing to vexport@akko.com.tr special designs can be made for your workpiece. / Bei Einreichung von der technische Zeichnung an export@akko.com.tr können auch Werkzeug spezifische Entwürfe hergestellt werden.

POLYGON FREZELEME
POLYGON MILLING
WERKZEUGE FÜR POLYGON

AKKO®

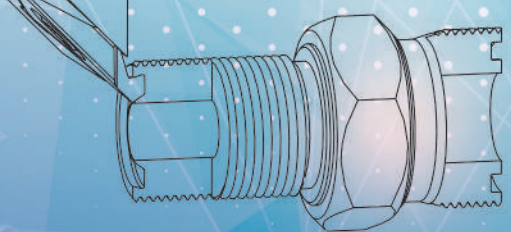
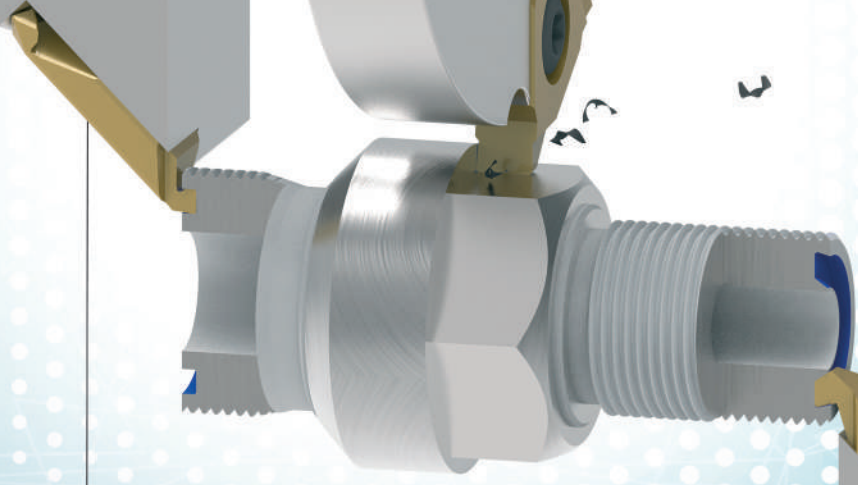
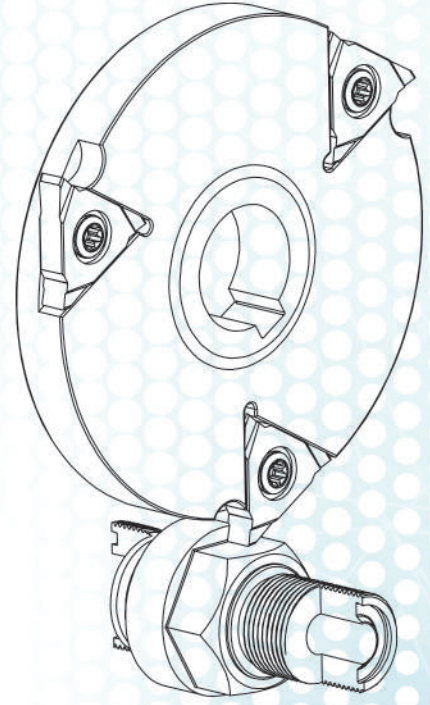

KANAL AÇMA
GROOVING
EINSTECHBOHRUNG

AKKO®

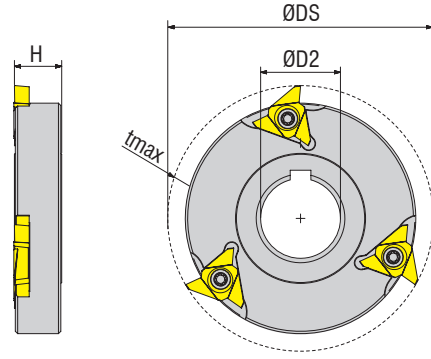
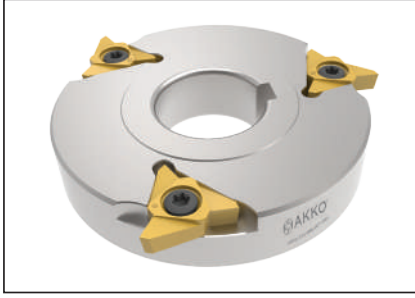

Takım Kodu Ordering Code Bestell-Bezeichnung	Stok Stock Lager		Takım Ölçüleri (mm) Dimension (mm) Abmessung (mm)				Kesici Uç Insert Wendeschneidplatte	Yedek Parçaları / Spare Parts / Ersatzteile		
	R	L	ØDS	ØD2	ZEFP	H		Tmax	Sıkma Vidası Screw Schraube	Tork Anahtar Torx Key Torx-Schlüssel
APTR/L-T12-D90-D27-Z02	○	○	90	27	2	16.20	5	T12..	1020.M5X11	80-T20
APTR/L-T12-D90-D27-Z03	○	○	90	27	3	16.20	5			

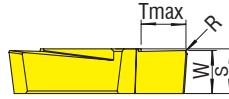
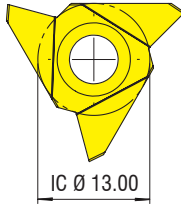
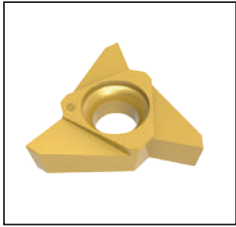



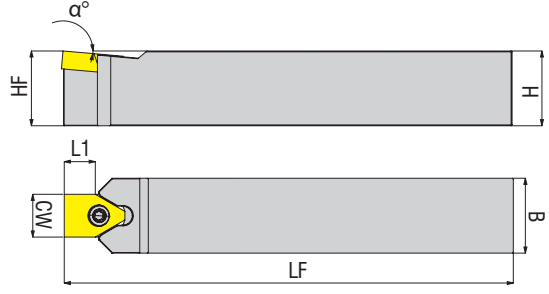
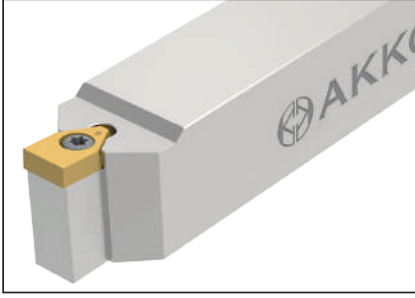

Uç Kodu Insert Code Wendeplatten-Bezeichnung	Stok Stock Lager	Uç Ölçüleri (mm) Insert Dimension (mm) Abmessung (mm)					ZEFP	Kalite Grade Sorte
		W	Tmax	R	K	S		
T12.15.0500.05.020 R/L	○	5	5	0.2	5°	5.2	3	VK20F01

R: Sağ / Right / Rechts L: Sol / Left / Links
● Stokta / In Stock / Auf Lager ○ Stokta Yok / Non Stock Item / Kein Lagerartikel, Lieferzeit auf Anfrage

Sipariş Örneği/Ordering Example/Bestellbeispiel
1 ad./pcs./stück APTR-T12-D90-D27-Z02



Takım Kodu Ordering Code Bestell-Bezeichnung	Stok Stock Lager	Takım Ölçüleri (mm) Dimension (mm) Abmessung (mm)							Yedek Parçaları / Spare Parts / Ersatzteile			
		H	B	LF	HF	L1	α	CW	Kesici Uç Insert Wendeschneidplatte	Sıkma Vidası Screw Schraube		
ADKT-B41-1616-L125	○	16	16	125	16	8	5°	10				
ADKT-B41-2020-L125	○	20	20	125	20	8	5°	10			B41.00.0400	4015-M4x11
ADKT-B41-2525-L150	○	25	25	150	25	8	5°	10				
ADKT-B42-1616-L125	○	16	16	125	16	10	5°	14.30				
ADKT-B42-2020-L125	○	20	20	125	20	10	5°	14.30			B42.00.0600	1020-M5x14
ADKT-B42-2525-L150	○	25	25	150	25	10	5°	14.30				

Sipariş Örneği/Ordering Example/Bestellbeispiel
1 ad./pcs./stück ADKT-B41-1616-L125

Özel profil form kanal açma
Special profile grooving solutions
Lösungen zum Einstechen von Sonderprofilen

AKKO®

KANAL AÇMA ÖZEL ÇÖZÜMLER
GROOVING SPECIAL SOLUTIONS
NUTEN SPEZIELLE LÖSUNGEN

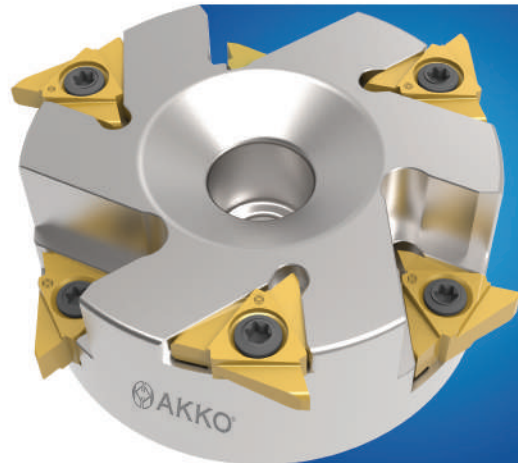
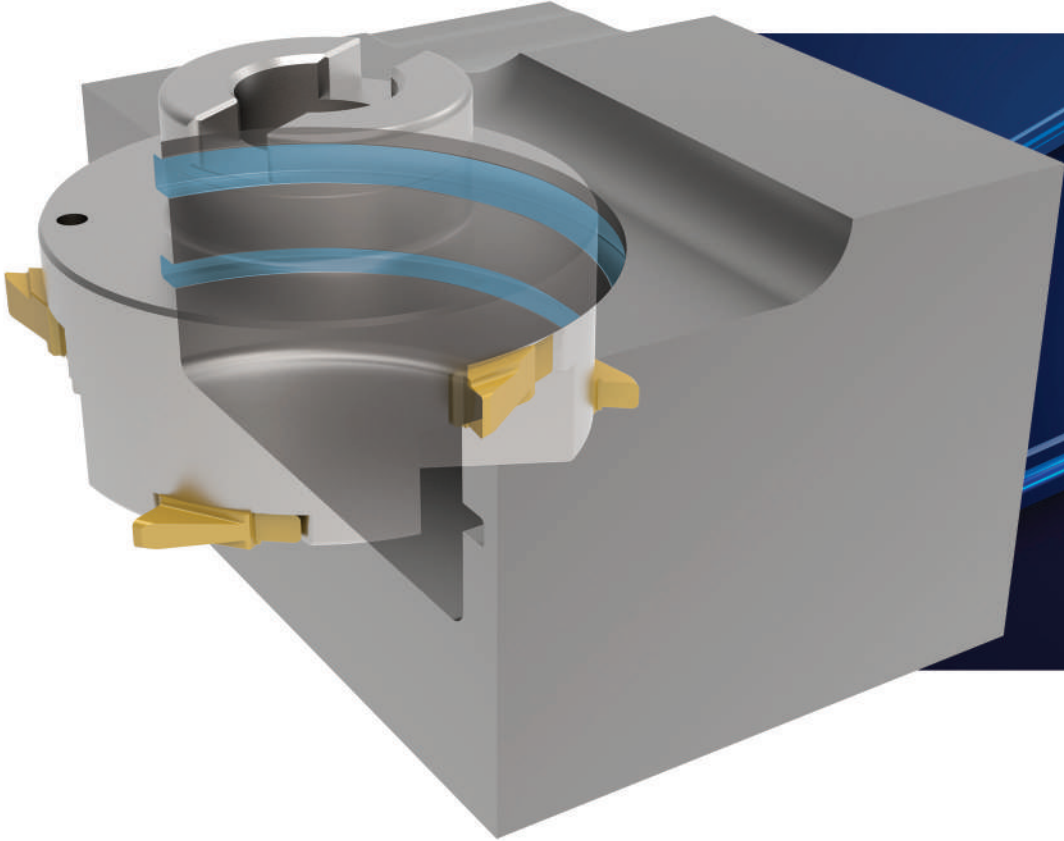

www.akko.com.tr





AKKO®

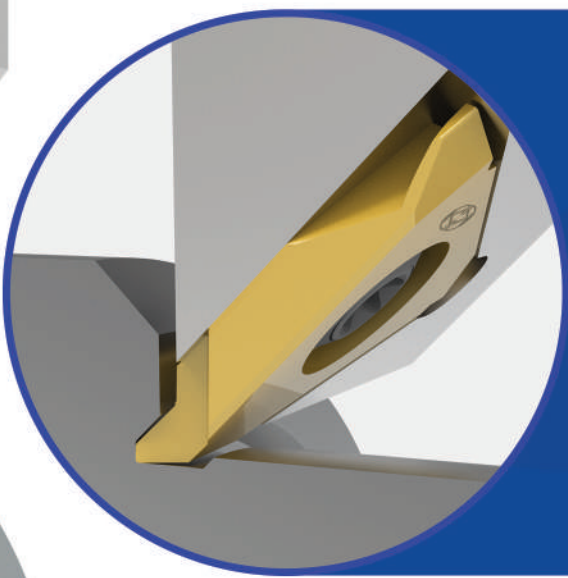

AKKO®

AKKO®

 AKKO®

KANAL AÇMA ÖZEL ÇÖZÜMLERİ
GROOVING SPECIAL SOLUTIONS
NUTEN SPEZIELLE LÖSUNGEN

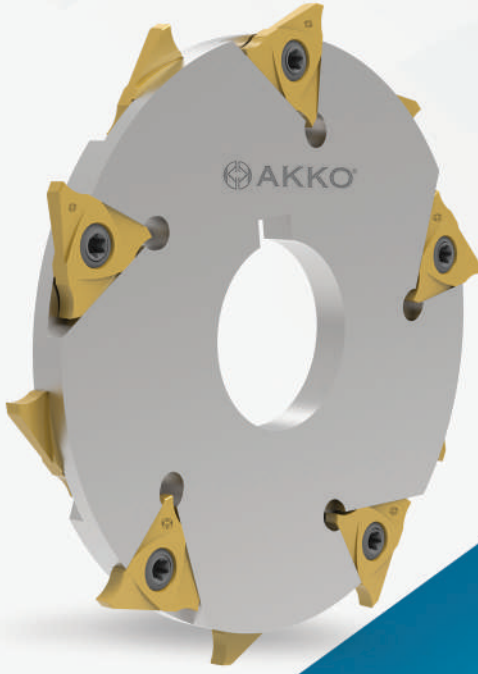

KANAL AÇMA
ÖZEL ÇÖZÜMLER
GROOVING
SPECIAL SOLUTIONS
NUTEN
SPEZIELLE
LÖSUNGEN

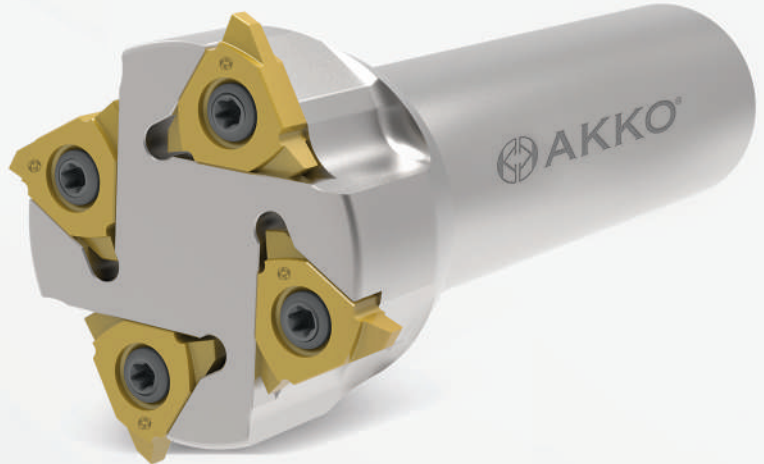
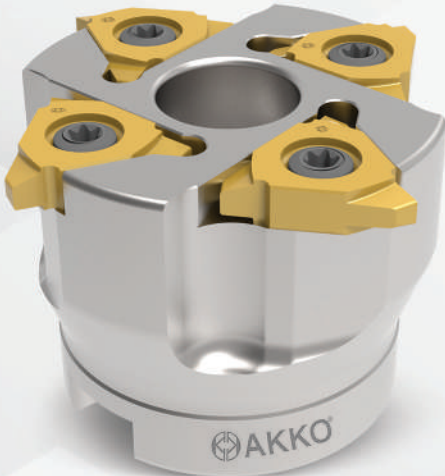

MICO CUT UÇLARI ve TAKIMLAR

MICO CUT INSERT and TOOLS

MICO CUT WENDESCHIEDPLATTEN WERKZEUGE

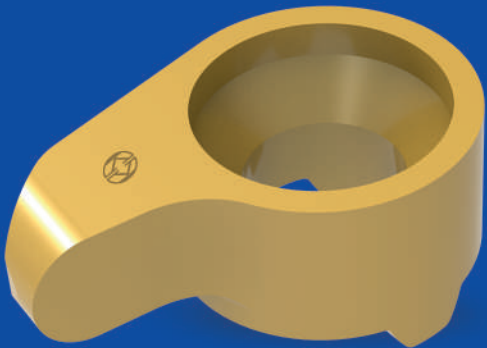
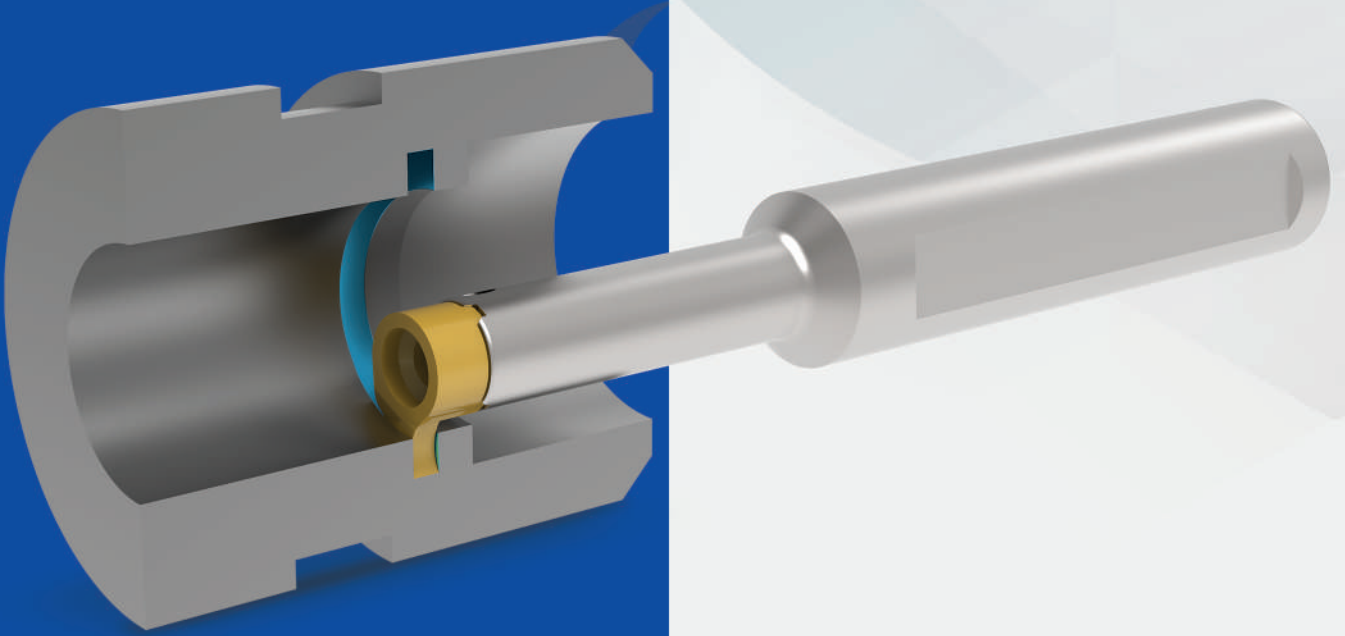

www.akko.com.tr

Yenilikler için bizi takip edin.

Follow us for news.

Für Neuheiten bitte uns folgen.

2025'te Stoklarda

**It will be available
at our stocks in 2025**

*Es wird im Jahr 2025
im Lager verfügbar sein*

ÇELİK ŞAFT
STEEL SHAFT
STAHSCHÄFTE

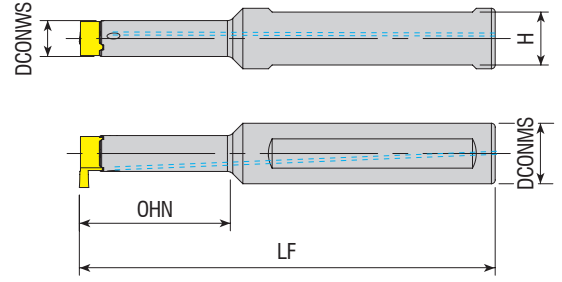

Takım Kodu Ordering Code Bestell-Bezeichnung	Stok Stock Lager	Takım Ölçüleri (mm) Dimension (mm) Abmessung (mm)					Kesici Uç Insert Wendeschneidplatte	Yedek Parçaları / Spare Parts / Ersatzteile		
		DCONMS	DCONWS	LF	OHN	H		Sıkma Vidası Screw Klemmschraube	Tork Anahtar Torx Key Torx Innensechskantschlüssel	
A12G-MC08-015	○	12	8	90	15	11	MC08	4015xM4X11	80-T15	
A12G-MC08-022	○	12	8	90	22	11				
A12G-MC11-019	○	12	11	90	19	15	MC11	T20-M5X14	80-T20	
A16G-MC11-028	○	16	11	100	28	15				
A16J-MC11-040	○	16	11	110	40	15				

KARBÜR ŞAFT
CARBIDE SHAFT
HARTMETALLSCHAFT

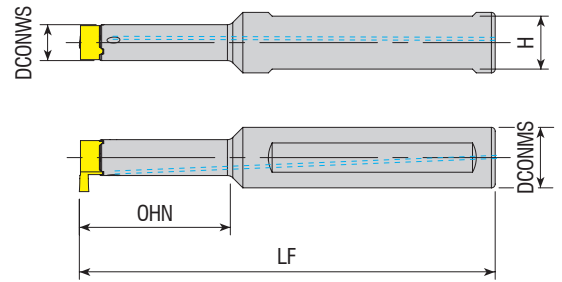

Takım Kodu Ordering Code Bestell-Bezeichnung	Stok Stock Lager	Takım Ölçüleri (mm) Dimension (mm) Abmessung (mm)					Kesici Uç Insert Wendeschneidplatte	Yedek Parçaları / Spare Parts / Ersatzteile		
		DCONMS	DCONWS	LF	OHN	H		Sıkma Vidası Screw Klemmschraube	Tork Anahtar Torx Key Torx Innensechskantschlüssel	
E12J-MC08-042	○	12	8	110	42	11	MC08	4015xM4X11	80-T15	
E12K-MC08-056	○	12	8	120	56	11				
E12J-MC11-040	○	12	11	130	40	15	MC11	T20-M5X14	80-T20	
E16K-MC11-056	○	16	11	130	56	15				
E16K-MC11-080	○	16	11	150	80	15				

● Stokta / In Stock / Auf Lager ○ Stokta Yok / Non Stock Item / Kein Lagerartikel, Lieferzeit auf Anfrage

Sipariş Örneği/Ordering Example/Bestellbeispiel
1 ad./pcs./stück A12G-MC08-015

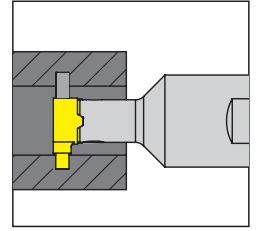
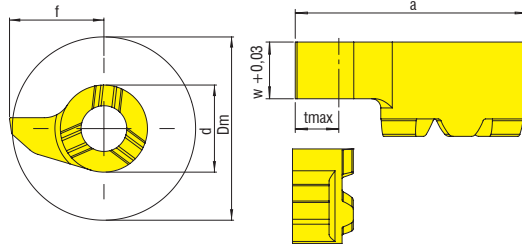
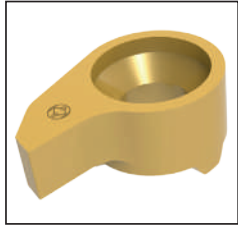

Uç Kodu Insert Code Wendepplatten-Bezeichnung	Stok Stock Lager	Uç Ölçüleri (mm) Insert Dimension (mm) Abmessung (mm)							UYUMLU TAKIM / COMPATIBLE TOOLHOLDER / KOMPATIBLES WERKZEUG	Kalite Grade Sorte
		W	R	a	d	f	tmax	Dm		
MC08.G.0100.010.01340	○	1.0	0.10	10.7	8.0	6.7	2.3	13.4-MC08-0..	VP3001
MC08.G.0150.015.01340	○	1.5	0.15	10.7	8.0	6.7	2.3	13.4		VP3001
MC08.G.0200.020.01340	○	2.0	0.20	10.7	8.0	6.7	2.3	13.4		VP3001
MC08.G.0250.025.01340	○	2.5	0.25	10.7	8.0	6.7	2.3	13.4		VP3001
MC08.G.0300.030.01340	○	3.0	0.30	10.7	8.0	6.7	2.3	13.4		VP3001

DIĞER PROFİL ÇEŞİTLERİ / THE OTHERS PROFILE TYPES / ANDERE PROFIL-TYPEN

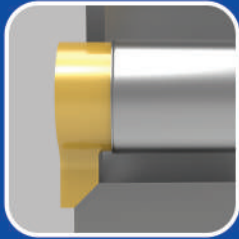

CHAMFER PROFILE

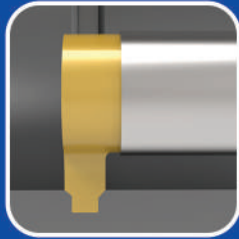

CIRCLIP PROFILE



THREAD PROFILE

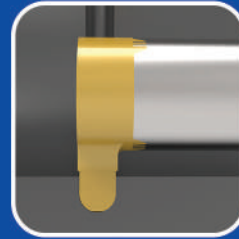

RADIUS GROVE PROFILE

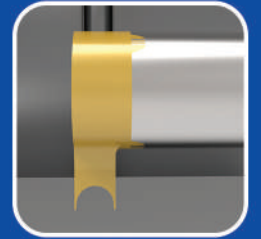

SPECIAL PROFILE

*Diğer profil uçlar özel taleplere göre üretilmektedir. / Profiled inserts are manufactured according to customer special requirements. /
Die Profil-Wendeschneidplatten werden nach Kundenwunsch gefertigt.

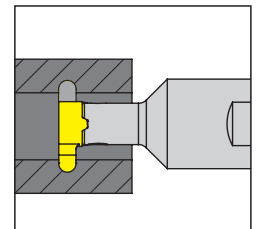
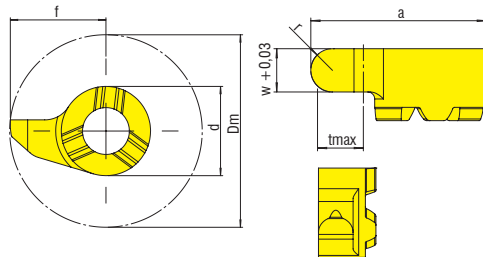
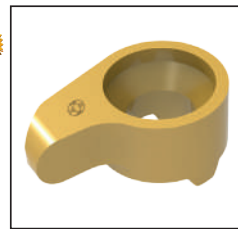

Uç Kodu Insert Code Wendepplatten-Bezeichnung	Stok Stock Lager	Uç Ölçüleri (mm) Insert Dimension (mm) Abmessung (mm)							UYUMLU TAKIM / COMPATIBLE TOOLHOLDER / KOMPATIBLES WERKZEUG	Kalite Grade Sorte
		W	R	a	d	f	tmax	Dm		
MC08.GR.0080.040.01340	○	0.8	0.4	10.7	8	6.7	2.3	13.4-MC08-0..	VP3001
MC08.GR.0120.060.01340	○	1.2	0.6	10.7	8	6.7	2.3	13.4		VP3001
MC08.GR.0180.090.01340	○	1.8	0.9	10.7	8	6.7	2.3	13.4		VP3001
MC08.GR.0200.100.01340	○	2.0	1.0	10.7	8	6.7	2.3	13.4		VP3001
MC08.GR.0300.150.01340	○	3.0	1.5	10.7	8	6.7	2.3	13.4		VP3001

● Stokta / In Stock / Auf Lager ○ Stokta Yok / Non Stock Item / Kein Lagerartikel, Lieferzeit auf Anfrage

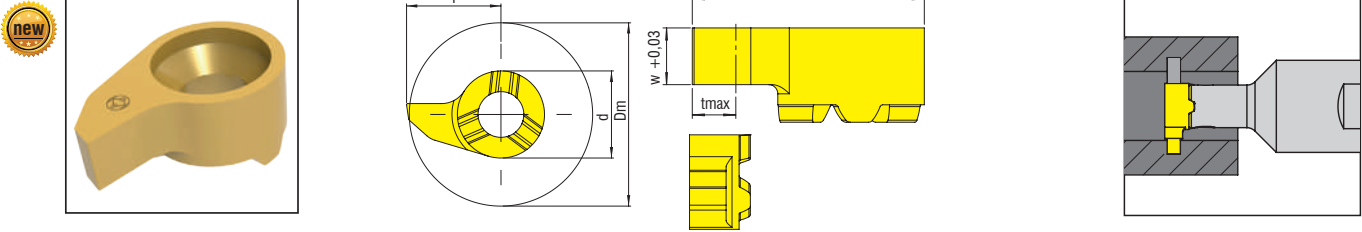

Uç Kodu Insert Code Wendepplatten-Bezeichnung	Stok Stock Lager	Uç Ölçüleri (mm) Insert Dimension (mm) Abmessung (mm)							UYUMLU TAKIM / COMPATIBLE TOOLHOLDER / KOMPATIBLES WERKZEUG	Kalite Grade Sorte
		W	R	a	d	f	tmax	Dm		
MC11.G.0100.010.02040	○	1.0	0.1	15.7	11	10.2	4.3	20.4-MC11-0..	VP3001
MC11.G.0150.015.02040	○	1.5	0.15	15.7	11	10.2	4.3	20.4		VP3001
MC11.G.0200.020.02040	○	2.0	0.2	15.7	11	10.2	4.3	20.4		VP3001
MC11.G.0250.025.02040	○	2.5	0.25	15.7	11	10.2	4.3	20.4		VP3001
MC11.G.0300.030.02040	○	3.0	0.3	15.7	11	10.2	4.3	20.4		VP3001
MC11.G.0350.035.02040	○	3.5	0.35	15.7	11	10.2	4.3	20.4		VP3001
MC11.G.0400.040.02040	○	4.0	0.40	15.7	11	10.2	4.3	20.4		VP3001

DIĞER PROFİL ÇEŞİTLERİ / THE OTHERS PROFILE TYPES / ANDERE PROFIL-TYPEN

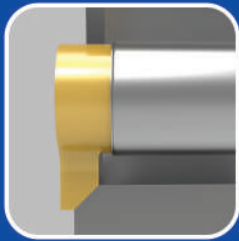

CHAMFER PROFILE

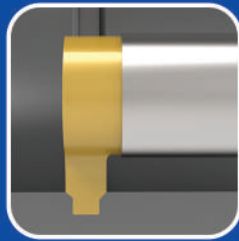

CIRCLIP PROFILE



THREAD PROFILE

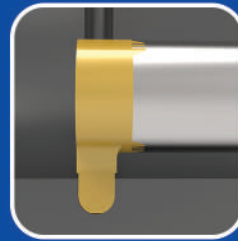

RADIUS GROVE PROFILE

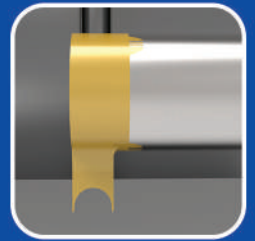

SPECIAL PROFILE

*Diğer profil uçlar özel taleplere göre üretilmektedir. / Profiled inserts are manufactured according to customer special requirements. /
Die Profil-Wendeschneidplatten werden nach Kundenwunsch gefertigt.

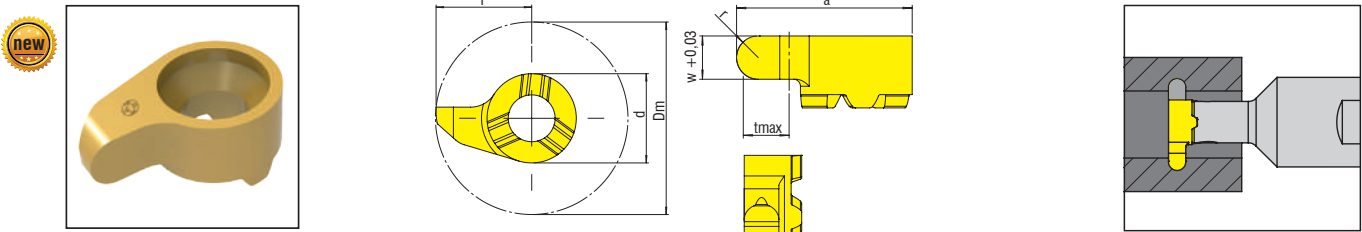

Uç Kodu Insert Code Wendepplatten-Bezeichnung	Stok Stock Lager	Uç Ölçüleri (mm) Insert Dimension (mm) Abmessung (mm)							UYUMLU TAKIM / COMPATIBLE TOOLHOLDER / KOMPATIBLES WERKZEUG	Kalite Grade Sorte
		W	R	a	d	f	tmax	Dm		
MC11.GR.0180.090.02040	○	1.8	0.9	15.7	11.0	10.2	4.3	20.4-MC11-0..	VP3001
MC11.GR.0220.110.02040	○	2.2	1.1	15.7	11.0	10.2	4.3	20.4		VP3001
MC11.GR.0300.150.02040	○	3.0	1.5	15.7	11.0	10.2	4.3	20.4		VP3001
MC11.GR.0400.200.02040	○	4.0	2.0	15.7	11.0	10.2	4.3	20.4		VP3001

● Stokta / In Stock / Auf Lager ○ Stokta Yok / Non Stock Item / Kein Lagerartikel, Lieferzeit auf Anfrage

Sipariş Örneği/Ordering Example/Bestellbeispiel
1 ad./pcs./stück MC11.G.0100.010.02040

MİMİLL UÇLARI VE TAKIMLARI

MİMİLL INSERTS AND TOOLS

MİMİLL WENDESCHIEDPLATTEN WERKZEUGE

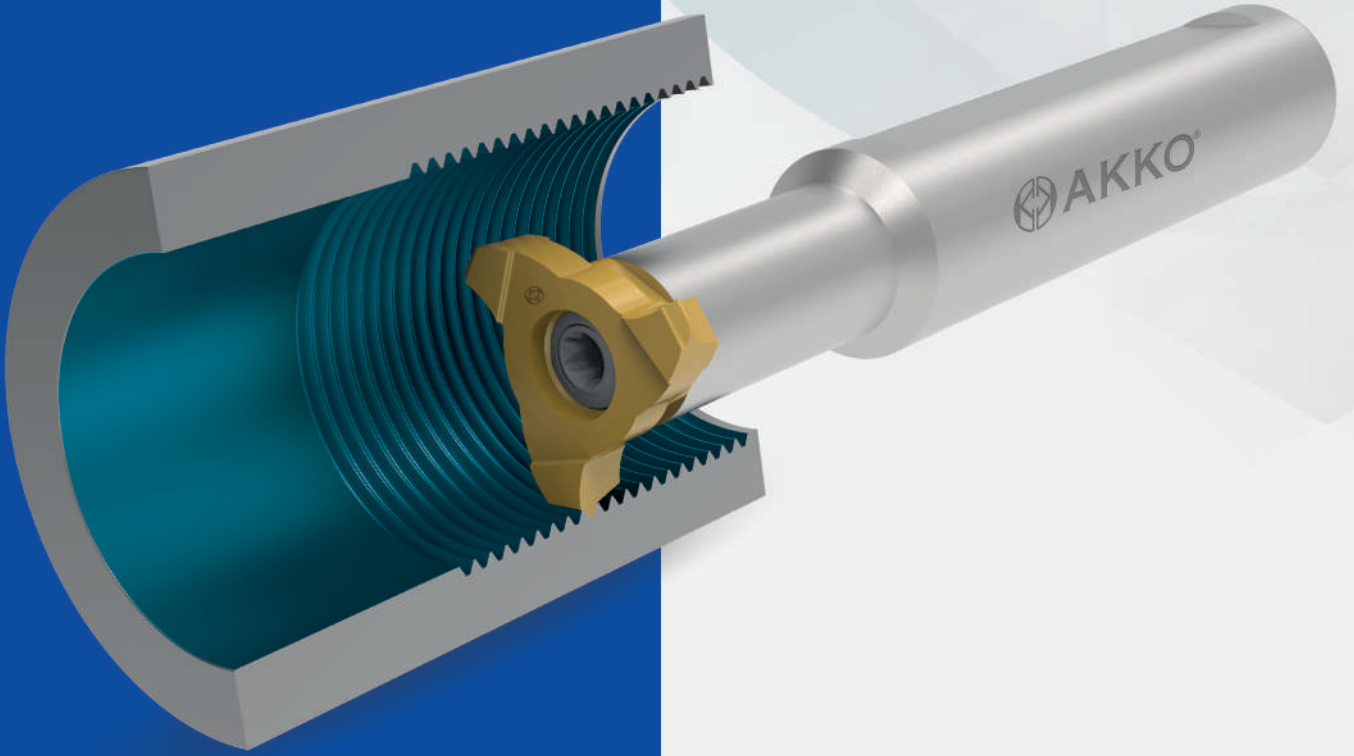

www.akko.com.tr

Yenilikler için bizi takip edin.
Follow us for news.
Für Neuheiten bitte uns folgen.

2025'te Stoklarda

**It will be available
at our stocks in 2025**

*Es wird im Jahr 2025
im Lager verfügbar sein*

MİMİLL UÇLARI VE TAKIMLARI
MİMİLL INSERTS AND TOOLS
MİMİLL WENDESCHIEDPLATTEN WERKZEUGE

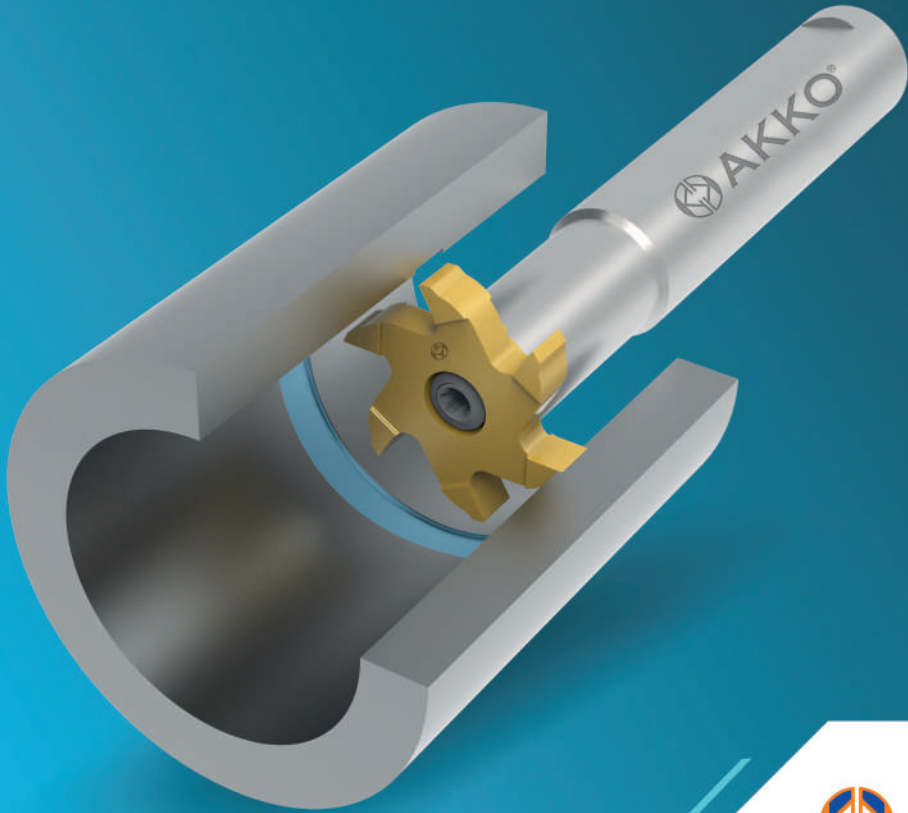
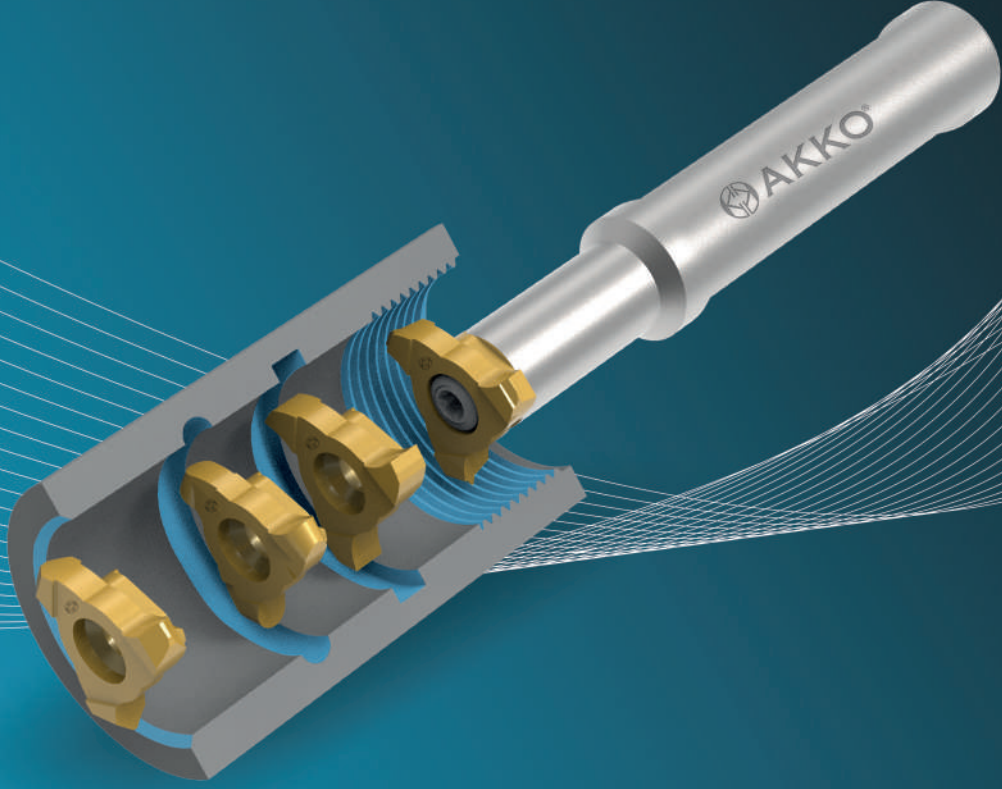

Ø Ds 17.7

ÇELİK ŞAFT
STEEL SHAFT
STAHL SCHAFT

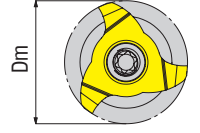
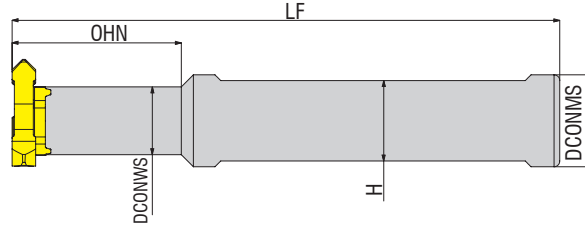

Takım Kodu Ordering Code Bestell-Bezeichnung	Stok Stock Lager	Takım Ölçüleri (mm) Dimension (mm) Abmessung (mm)					Kesici Uç Insert Wendeschneidplatte	Yedek Parçaları / Spare Parts / Ersatzteile	
		DCONMS	DCONWS	LF	OHN	H		Sıkma Vidası Screw Klemmschraube	Tork Anahtar Torx Key Torx Innensechskantschlüssel
A12E-MM1803-018	○	12	9	70	18	11	MM1803...	4015-M4x12	80-T15
A16F-MM1803-026	○	16	9	80	26	15			

Ø Ds 17.7

KARBÜR ŞAFT
CARBIDE SHAFT
HARTMETALLSCHAFT

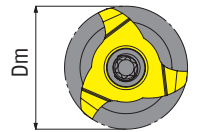
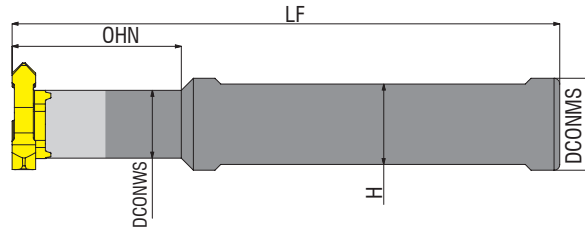

Takım Kodu Ordering Code Bestell-Bezeichnung	Stok Stock Lager	Takım Ölçüleri (mm) Dimension (mm) Abmessung (mm)					Kesici Uç Insert Wendeschneidplatte	Yedek Parçaları / Spare Parts / Ersatzteile	
		DCONMS	DCONWS	LF	OHN	H		Sıkma Vidası Screw Klemmschraube	Tork Anahtar Torx Key Torx Innensechskantschlüssel
E12H-MM1803-045	○	12	9	100	45	MM1803...	4015-M4x12	80-T15	
E12J-MM1803-064	○	12	9	110	64				-
E16H-MM1803-032	○	16	9	100	32				-
E16J-MM1803-045	○	16	9	110	45				-
E16K-MM1803-064	○	16	9	125	64				-

● Stokta / In Stock / Auf Lager ○ Stokta Yok / Non Stock Item / Kein Lagerartikel, Lieferzeit auf Anfrage

Sipariş Örneği/Ordering Example/Bestellbeispiel
1 ad./pcs./stück A12E-MM1803-018

∅Ds 17.7

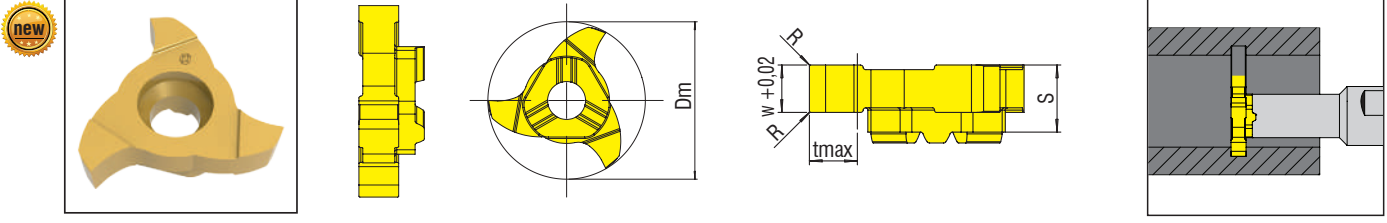

Uç Kodu Insert Code Wendepplatten-Bezeichnung	Stok Stock Lager	Uç Ölçüleri (mm) Insert Dimension (mm) Abmessung (mm)						UYUMLU TAKIM / COMPATIBLE TOOLHOLDER / KOMPATIBLES WERKZEUG	Kalite Grade Sorte
		Ds	W	R	tmax	S	Z		
MM1803.G.0150.010.0177	○	∅17.7	1.5	0.1	3.5	5.7	3-MM1803-0..	VP3001
MM1803.G.0200.020.0177	○	∅17.7	2.00	0.2	3.5	5.7	3		VP3001
MM1803.G.0250.020.0177	○	∅17.7	2.5	0.2	3.5	5.7	3		VP3001
MM1803.G.0300.010.0177	○	∅17.7	3	0.2	3.5	5.7	3		VP3001

● Stokta / In Stock / Auf Lager ○ Stokta Yok / Non Stock Item / Kein Lagerartikel, Lieferzeit auf Anfrage

Sipariş Örneği/Ordering Example/Bestellbeispiel
1 ad./pcs./ MM1803.G.0150.010.0177

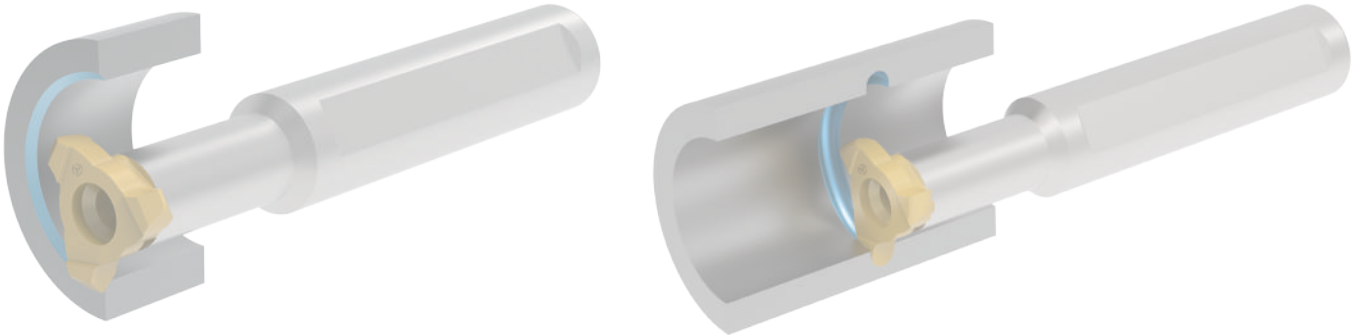

DİĞER PROFİL ÇEŞİTLERİ / THE OTHERS PROFILE TYPES / ANDERE PROFIL-TYPEN



THREAD PROFILE



GEAR PROFILE



RADIUS GROVE PROFILE



CIRCLIP PROFILE



CHAMFER PROFILE

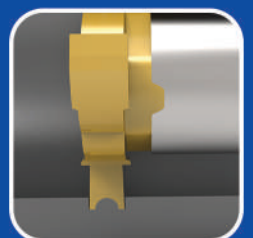

SPECIAL PROFILE

*Diğer profil uçlar özel taleplere göre üretilmektedir. / Profiled inserts are manufactured according to customer special requirements. / Die Profil-Wendeschneidplatten werden nach Kundenwunsch gefertigt.

Sipariş Örneği/Ordering Example/Bestellbeispiel
1 ad./pcs./stück MM1803.G.0150.010.0177

Ø Ds 21.7

ÇELİK ŞAFT
STEEL SHAFT
STAHL SCHAFT

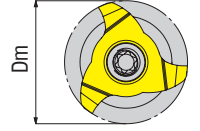
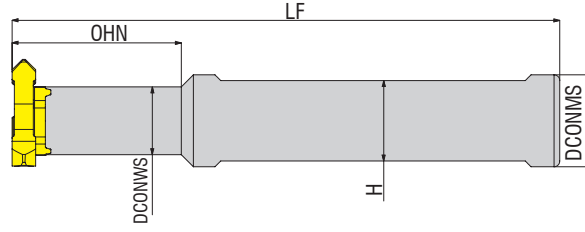

Takım Kodu Ordering Code Bestell-Bezeichnung	Stok Stock Lager	Takım Ölçüleri (mm) Dimension (mm) Abmessung (mm)					Kesici Uç Insert Wendescheidplatte	Yedek Parçaları / Spare Parts / Ersatzteile		
		DCONMS	DCONWS	LF	OHN	H		Sıkma Vidası Screw Klemmschraube	Tork Anahtar Torx Key Torx Innensechskantschlüssel	
A12E-MM2203-018	○	12	12	70	18	11	MM2203...	1020-M5x14	80-T20	
A16F-MM2203-026	○	16	12	80	26	15				

Ø Ds 21.7

KARBÜR ŞAFT
CARBIDE SHAFT
HARTMETALLSCHAFT

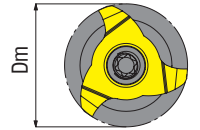
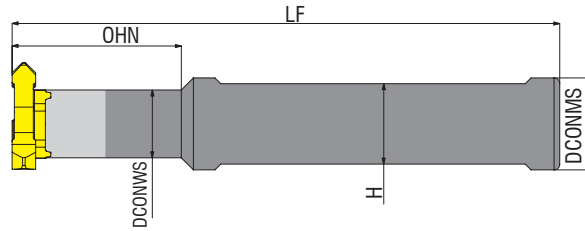

Takım Kodu Ordering Code Bestell-Bezeichnung	Stok Stock Lager	Takım Ölçüleri (mm) Dimension (mm) Abmessung (mm)					Kesici Uç Insert Wendescheidplatte	Yedek Parçaları / Spare Parts / Ersatzteile		
		DCONMS	DCONWS	LF	OHN	H		Sıkma Vidası Screw Klemmschraube	Tork Anahtar Torx Key Torx Innensechskantschlüssel	
E16H-MM2203-042	○	16	12	100	42	-	MM2203...	1020-M5x14	80-T20	
E16K-MM2203-060	○	16	12	125	60	-				
E16N-MM2203-085	○	16	12	160	85	-				

● Stokta / In Stock / Auf Lager ○ Stokta Yok / Non Stock Item / Kein Lagerartikel, Lieferzeit auf Anfrage

Sipariş Örneği/Ordering Example/Bestellbeispiel
1 ad./pcs./stück A12E-MM2203-018

ø Ds 21.7

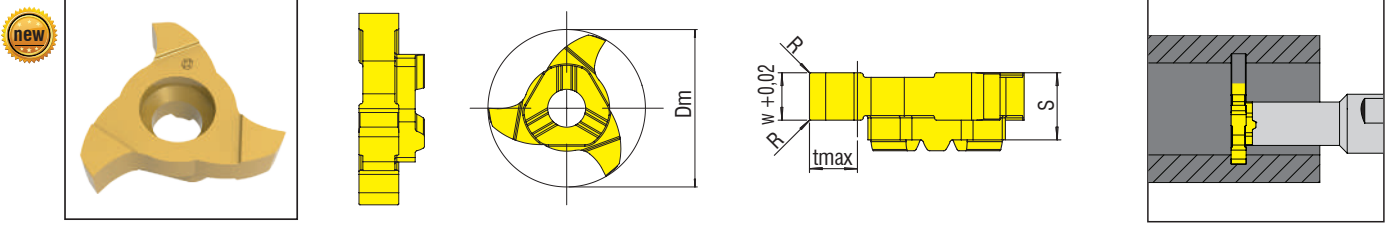

Uç Kodu Insert Code Wendeplatten-Bezeichnung	Stok Stock Lager	Uç Ölçüleri (mm) Insert Dimension (mm) Abmessung (mm)						UYUMLU TAKIM / COMPATIBLE TOOLHOLDER / KOMPATIBLES WERKZEUG	Kalite Grade Sorte
		Ds	W	R	tmax	S	Z		
MM2203.G.0150.010.2177	○	ø21.7	1.5	0.1	4.5	5.7	3-MM2203-0..	VP3001
MM2203.G.0200.020.2177	○	ø21.7	2.00	0.2	4.5	5.7	3		VP3001
MM2203.G.0250.020.2177	○	ø21.7	2.5	0.2	4.5	5.7	3		VP3001
MM2203.G.0300.020.2177	○	ø21.7	3	0.2	4.5	5.7	3		VP3001
MM2203.G.0350.020.2177	○	ø21.7	3.5	0.2	4.5	5.7	3		
MM2203.G.0400.020.2177	○	ø21.7	4	0.2	4.5	5.7	3		

● Stokta / In Stock / Auf Lager ○ Stokta Yok / Non Stock Item / Kein Lagerartikel, Lieferzeit auf Anfrage

Sipariş Örneği/Ordering Example/Bestellbeispiel
1 ad./pcs./stück MM2203.G.0150.010.2177

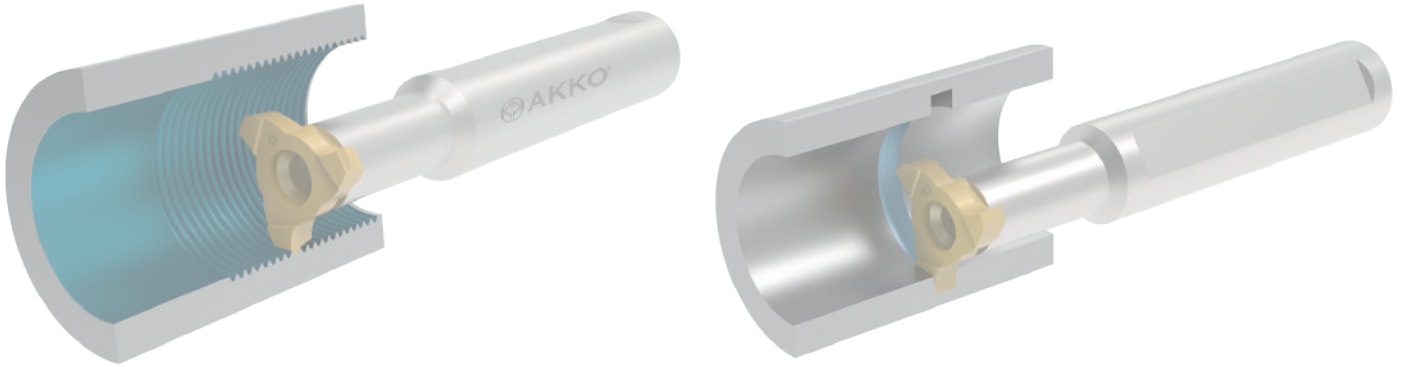

DİĞER PROFİL ÇEŞİTLERİ / THE OTHERS PROFILE TYPES / ANDERE PROFIL-TYPEN



THREAD PROFILE



GEAR PROFILE



RADIUS GROVE PROFILE



CIRCLIP PROFILE



CHAMFER PROFILE



SPECIAL PROFILE

*Diğer profil uçlar özel taleplere göre üretilmektedir. / Profiled inserts are manufactured according to customer special requirements. /
Die Profil-Wendeschnidplatten werden nach Kundenwunsch gefertigt.

Ø Ds 27.7

ÇELİK ŞAFT
STEEL SHAFT
STAHL SCHAFT

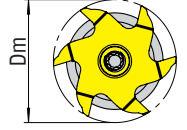
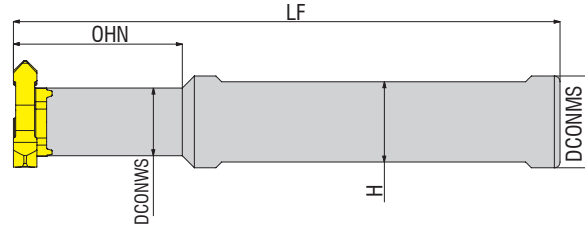

Takım Kodu Ordering Code Bestell-Bezeichnung	Stok Stock Lager	Takım Ölçüleri (mm) Dimension (mm) Abmessung (mm)					Kesici Uç Insert Wendescheidplatte	Yedek Parçaları / Spare Parts / Ersatzteile		
		DCONMS	DCONWS	LF	OHN	H		Sıkma Vidası Screw Klemmschraube	Tork Anahtar Torx Key Torx Innensechskantschlüssel	
A12E-MM2806-020	○	12	14.5	70	20	11	MM2806	1020-M5x14	80-T20	
A16G-MM2806-036	○	16	14.5	90	36	15				
A20H-MM2806-036	○	20	14.5	100	36	18				

Ø Ds 27.7

KARBÜR ŞAFT
CARBIDE SHAFT
HARTMETALLSCHAFT

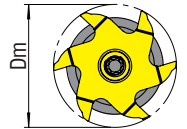
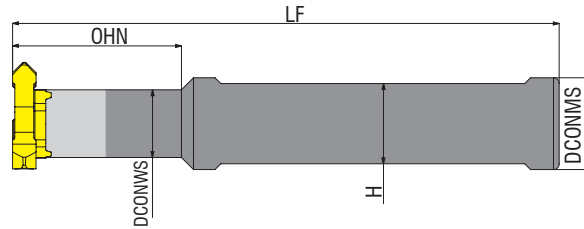

Takım Kodu Ordering Code Bestell-Bezeichnung	Stok Stock Lager	Takım Ölçüleri (mm) Dimension (mm) Abmessung (mm)					Kesici Uç Insert Wendescheidplatte	Yedek Parçaları / Spare Parts / Ersatzteile		
		DCONMS	DCONWS	LF	OHN	H		Sıkma Vidası Screw Klemmschraube	Tork Anahtar Torx Key Torx Innensechskantschlüssel	
E16H-M2806-042	○	16	14.5	100	42	-	MM2806...	1020-M5x14	80-T20	
E16L-M2806-060	○	16	14.5	125	60	-				
E20L-M2806-060	○	20	14.5	125	60	-				
E20N-M2806-085	○	20	14.5	160	85	-				

● Stokta / In Stock / Auf Lager ○ Stokta Yok / Non Stock Item / Kein Lagerartikel, Lieferzeit auf Anfrage

Sipariş Örneği/Ordering Example/Bestellbeispiel
1 ad./pcs./stück A12E-MM2806-020



Ø Ds 27.7

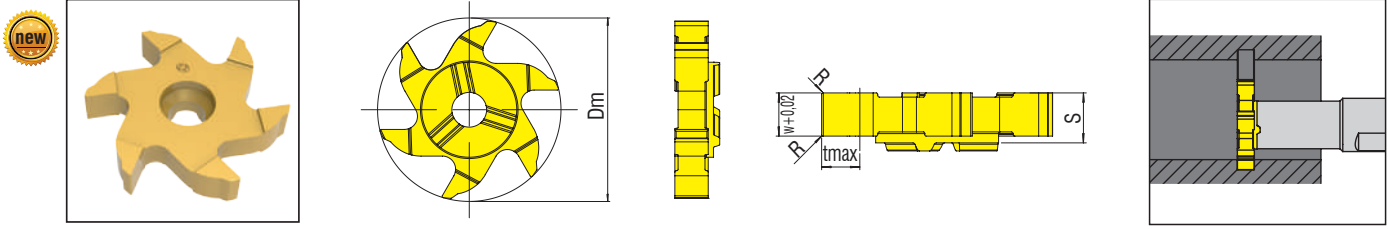

Uç Kodu Insert Code Wendepplatten-Bezeichnung	Stok Stock Lager	Uç Ölçüleri (mm) Insert Dimension (mm) Abmessung (mm)						UYUMLU TAKIM / COMPATIBLE TOOLHOLDER / KOMPATIBLES WERKZEUG	Kalite Grade Sorte
		Ds	W	R	tmax	S	Z		
MM2806.G.0250.020.2770	○	Ø27.7	2.5	0.2	6.5	5.9	6-MM2806-0..	VP3001
MM2806.G.0300.020.2770	○	Ø27.7	3.00	0.2	6.5	5.9	6		VP3001
MM2806.G.0350.020.2770	○	Ø27.7	3.5	0.2	6.5	5.9	6		VP3001
MM2806.G.0400.020.2770	○	Ø27.7	4.00	0.2	6.5	5.9	6		VP3001
MM2806.G.0450.020.2770	○	Ø27.7	4.5	0.2	6.5	5.9	6		VP3001
MM2806.G.0500.020.2770	○	Ø27.7	5.00	0.2	6.5	5.9	6		VP3001

● Stokta / In Stock / Auf Lager ○ Stokta Yok / Non Stock Item / Kein Lagerartikel, Lieferzeit auf Anfrage

Sipariş Örneği/Ordering Example/Bestellbeispiel
1 ad./pcs./stück MM2806.G.0250.020.2770

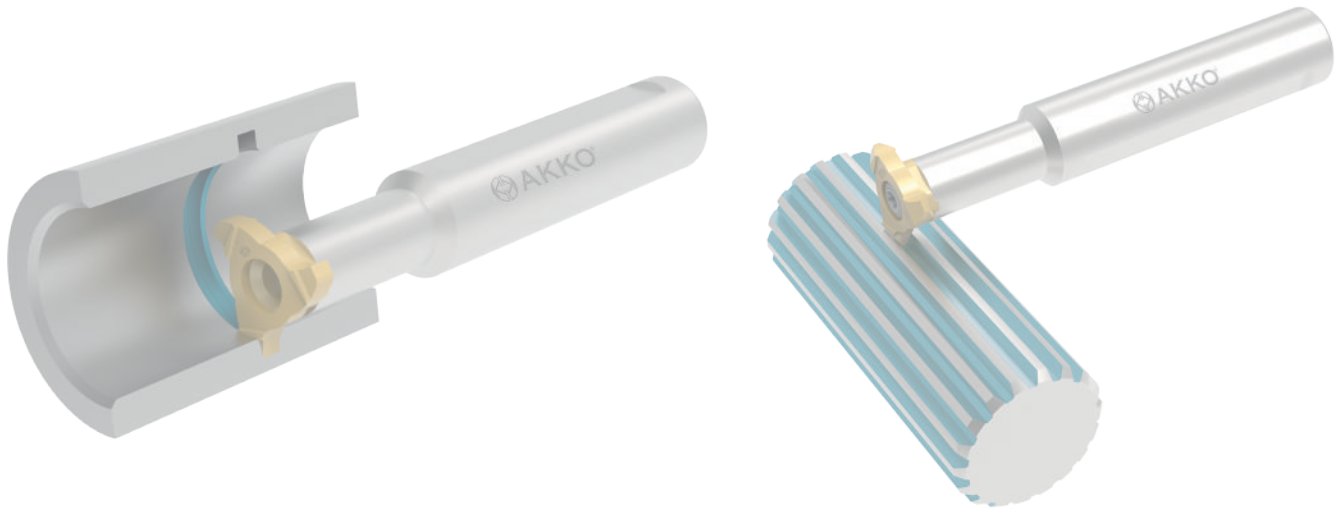

DİĞER PROFİL ÇEŞİTLERİ / THE OTHERS PROFILE TYPES / ANDERE PROFIL-TYPEN

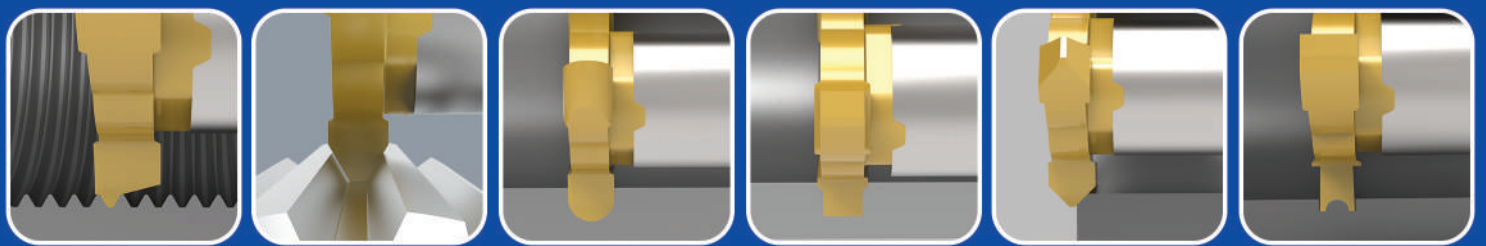

THREAD PROFILE

GEAR PROFILE

RADIUS GROOVE PROFILE

CIRCLIP PROFILE

CHAMFER PROFILE

SPECIAL PROFILE

*Diğer profil uçlar özel taleplere göre üretilmektedir. / Profiled inserts are manufactured according to customer special requirements. /
Die Profil-Wendeschneidplatten werden nach Kundenwunsch gefertigt.

Ø Ds 31.7

ÇELİK ŞAFT
STEEL SHAFT
STAHL SCHAFT

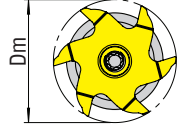
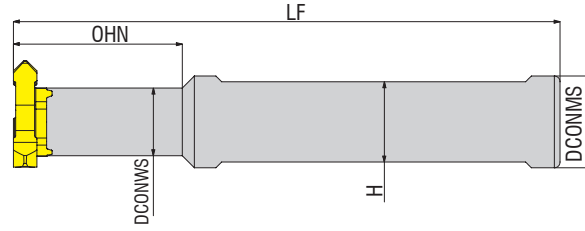

Takım Kodu Ordering Code Bestell-Bezeichnung	Stok Stock Lager	Takım Ölçüleri (mm) Dimension (mm) Abmessung (mm)					Kesici Uç Insert Wendeschneidplatte	Yedek Parçaları / Spare Parts / Ersatzteile	
		DCONMS	DCONWS	LF	OHN	H		Sıkma Vidası Screw Klemmschraube	Tork Anahtar Torx Key Torx Innensechskantschlüssel
A16G-MM3306-036	○	16	14.5	90	36	15	MM3306...	1020-M5x14	80-T20
A20H-MM3306-036	○	20	14.5	100	36	18			

Ø Ds 31.7

KARBÜR ŞAFT
CARBIDE SHAFT
HARTMETALLSCHAFT

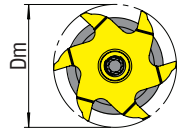
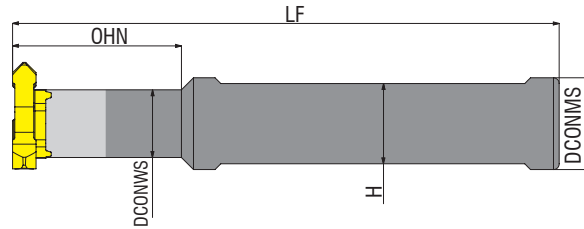

Takım Kodu Ordering Code Bestell-Bezeichnung	Stok Stock Lager	Takım Ölçüleri (mm) Dimension (mm) Abmessung (mm)					Kesici Uç Insert Wendeschneidplatte	Yedek Parçaları / Spare Parts / Ersatzteile	
		DCONMS	DCONWS	LF	OHN	H		Sıkma Vidası Screw Klemmschraube	Tork Anahtar Torx Key Torx Innensechskantschlüssel
E16H-MM3306-042	○	16	14.5	100	42	MM3306...	1020-M5x14	80-T20	
E16K-MM3306-060	○	16	14.5	125	60				-
E20H-MM3306-042	○	20	14.5	100	42				-
E20K-MM3306-060	○	20	14.5	125	60				-
E20N-MM3306-085	○	20	14.5	160	85				-

● Stokta / In Stock / Auf Lager ○ Stokta Yok / Non Stock Item / Kein Lagerartikel, Lieferzeit auf Anfrage

Sipariş Örneği/Ordering Example/Bestellbeispiel

1 ad./pcs./stück A16G-MM3306-036



ø Ds 31.7

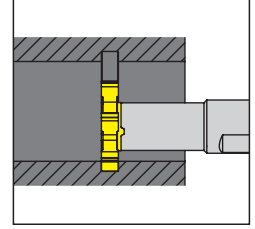
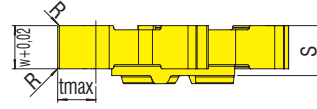
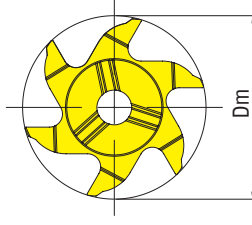
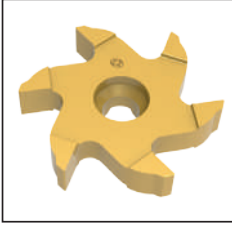

Uç Kodu Insert Code Wendepplatten-Bezeichnung	Stok Stock Lager	Uç Ölçüleri (mm) Insert Dimension (mm) Abmessung (mm)						UYUMLU TAKIM / COMPATIBLE TOOLHOLDER / KOMPATİBELES WERKZEUG	Kalite Grade Sorte
		Ds	W	R	tmax	S	Z		
MM3306.G.0200.020.3170	○	ø31.7	ø2.5	0.2	8.3	5.9	6-MM3306-0..	VP3001
MM3306.G.0250.020.3170	○	ø31.7	ø2.5	0.2	8.3	5.9	6		VP3001
MM3306.G.0300.020.3170	○	ø31.7	ø3.0	0.2	8.3	5.9	6		VP3001
MM3306.G.0400.020.3170	○	ø31.7	ø4.0	0.2	8.3	5.9	6		VP3001

● Stokta / In Stock / Auf Lager ○ Stokta Yok / Non Stock Item / Kein Lagerartikel, Lieferzeit auf Anfrage

Sipariş Örneği/Ordering Example/Bestellbeispiel
1 ad./pcs./stück MM3306.G.0200.020.3170

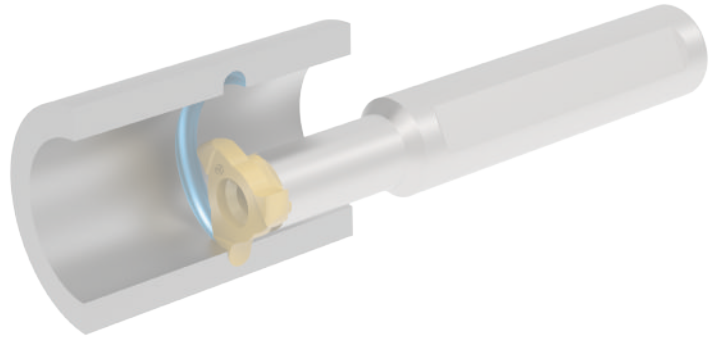
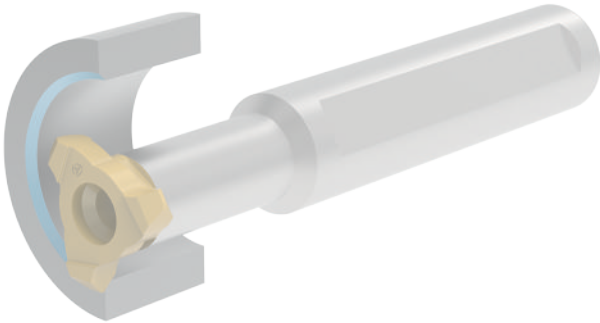

DİĞER PROFİL ÇEŞİTLERİ / THE OTHERS PROFILE TYPES / ANDERE PROFIL-TYPEN



THREAD PROFILE



GEAR PROFILE

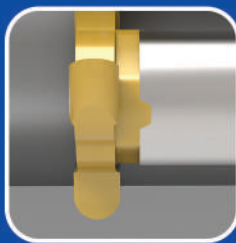

RADIUS GROVE PROFILE

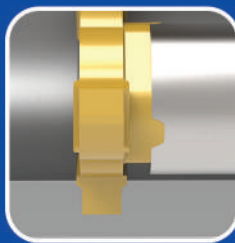

CIRCLIP PROFILE



CHAMFER PROFILE

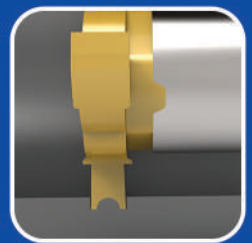

SPECIAL PROFILE



*Diğer profil uçlar özel taleplere göre üretilmektedir. / Profiled inserts are manufactured according to customer special requirements. /
Die Profil-Wendeschneidplatten werden nach Kundenwunsch gefertigt.

SEGMAN UÇLARI VE TAKIMLARI

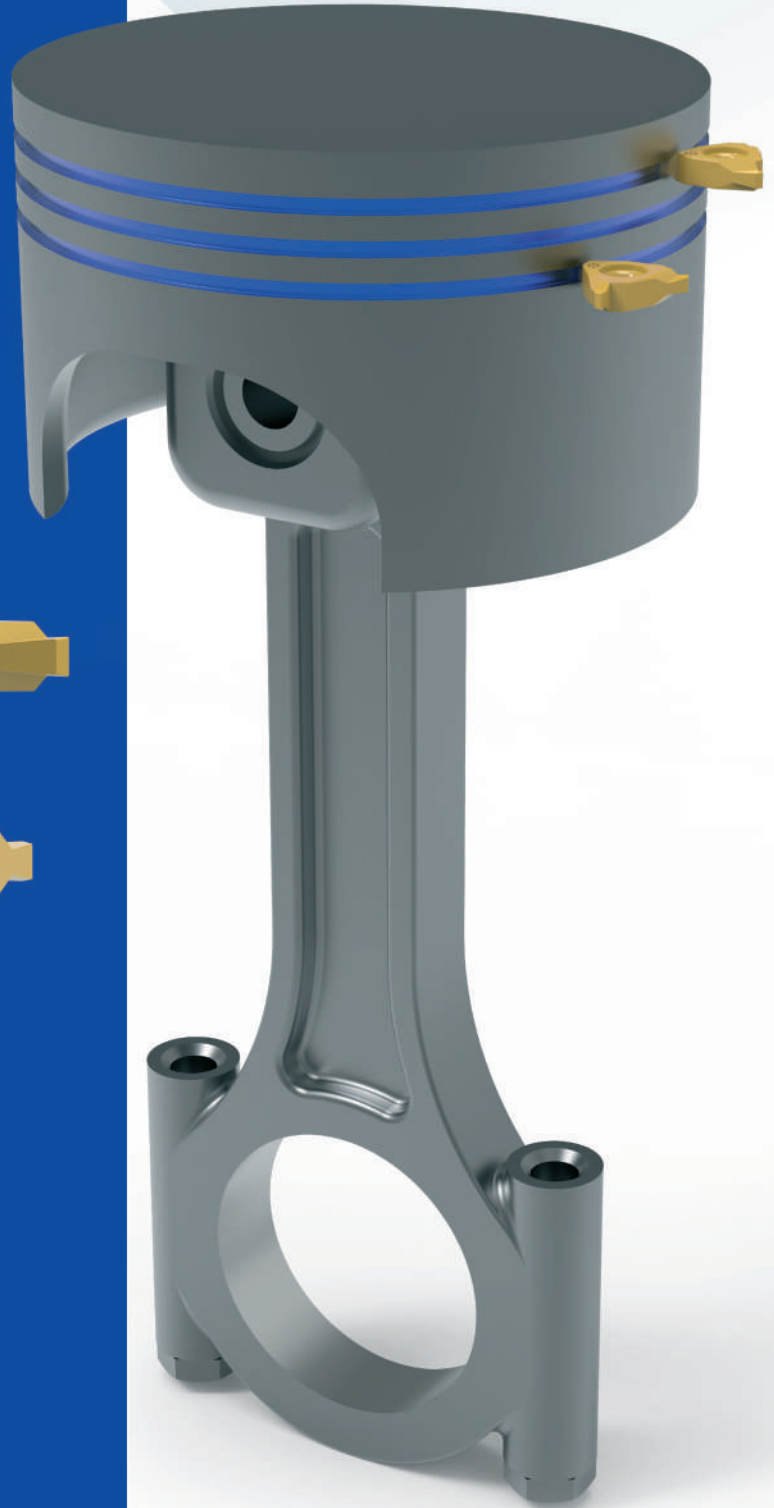
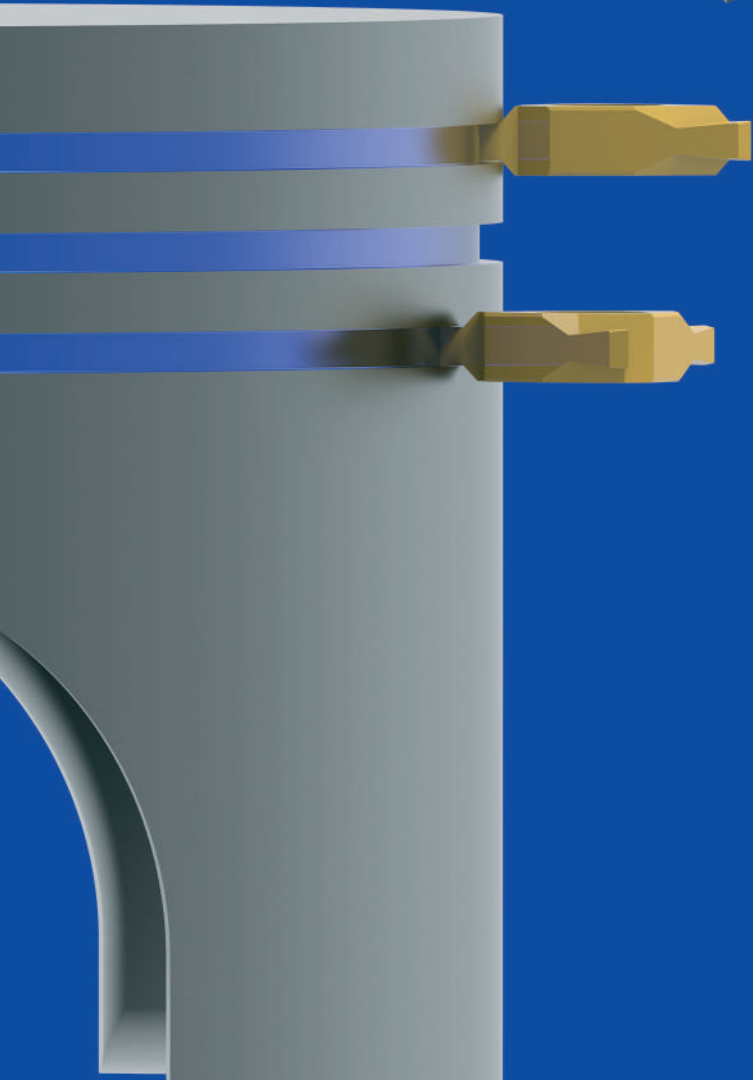

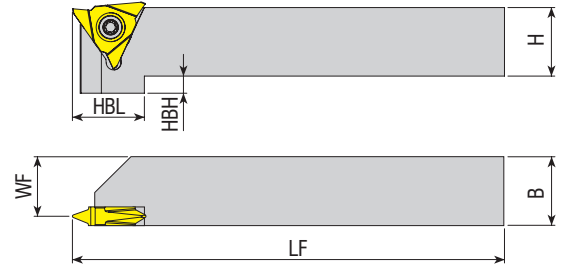
RING INSERTS AND TOOLHOLDERS
RINGEINSÄTZE UND WERKZEUGHALTER



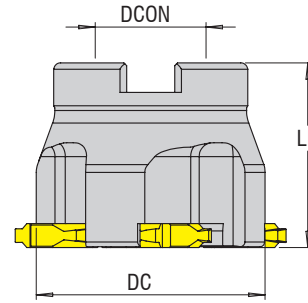
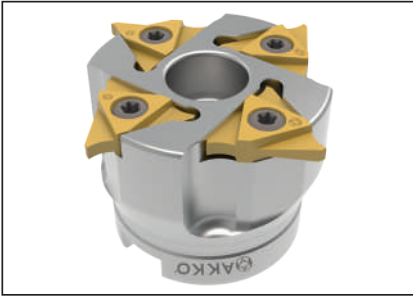

Takım Kodu Ordering Code Bestell-Bezeichnung	Stok Stock Lager		Takım Ölçüleri (mm) Dimension (mm) Abmessung (mm)					Kesici Uç Insert Wendeschneidplatte	Yedek Parçaları / Spare Parts / Ersatzteile		
	R	L	H	B	WF	LF	HBL		HBH	Sıkma Vidası Screw Schraube	Tork Anahtar Torx Key Torx-Schlüssel
ADKT-T12P-R/L-1616-T5	●	●	16	16	13.50	125	21	5			
ADKT-T12P-R/L-2020-T5	●	●	20	20	17.50	125	21	5			
ADKT-T12P-R/L-2525-T5	●	●	25	25	22.50	150	-	-			
ADKT-T12P-R/L-3232-T5	●	●	32	32	29.50	170	-	-			



Takım Kodu Ordering Code Bestell-Bezeichnung	Takım Ölçüleri (mm) Dimension (mm) Abmessung (mm)					Kesici Uç Insert Wendeschneidplatte	Yedek Parçaları / Spare Parts / Ersatzteile	
	DC	ZEFP	DCON	LF	APMX		Sıkma Vidası Screw Schraube	Tork Anahtar Torx Key Torx-Schlüssel
ASFMT12-D60x5.2-A22-Z04	60	4	22	40	-			

Sipariş Örneği/Ordering Example/Bestellbeispiel
1 ad./pcs./stück ADKT-T12P-R/L-1616-T5

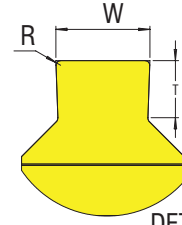
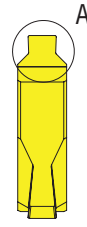
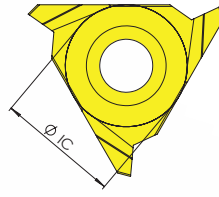

DETAY A

Ürün Kodu Product Code Artikelnummer	Stok Stock Lager	Uç Ölçüleri (mm) Insert Dimension (mm) Abmessung (mm)			
		IC	W	R	T
ASK-125-13	●	13	1.25	0.2	1.3
ASK-135-13	●	13	1.35	0.2	1.3
ASK-145-13	●	13	1.45	0.2	1.3
ASK-150-13	●	13	1.5	0.2	1.3
ASK-165-18	●	13	1.65	0.2	1.8
ASK-175-18	●	13	1.75	0.2	1.8
ASK-185-23	●	13	1.85	0.2	2.3
ASK-200-23	●	13	2	0.2	2.3
ASK-220-33	●	13	2.2	0.2	3.3
ASK-230-33	●	13	2.3	0.2	3.3
ASK-250-33	●	13	2.5	0.3	3.3
ASK-265-33	●	13	2.65	0.3	3.3
ASK-270-33	●	13	2.7	0.3	3.3
ASK-280-33	●	13	2.8	0.3	3.3
ASK-300-33	●	13	3	0.3	3.3
ASK-320-33	●	13	3.2	0.3	3.3
ASK-330-33	●	13	3.3	0.3	3.3
ASK-350-38	●	13	3.5	0.3	3.8
ASK-370-38	●	13	3.7	0.3	3.8
ASK-390-38	●	13	3.9	0.3	3.8
ASK-400-38	●	13	4	0.3	3.8

● Stokta / In Stock / Auf Lager ○ Stokta Yok / Non Stock Item / Kein Lagerartikel, Lieferzeit auf Anfrage

Sipariş Örneği/Ordering Example/Bestellbeispiel
1 ad./pcs./stück ASK-125-13

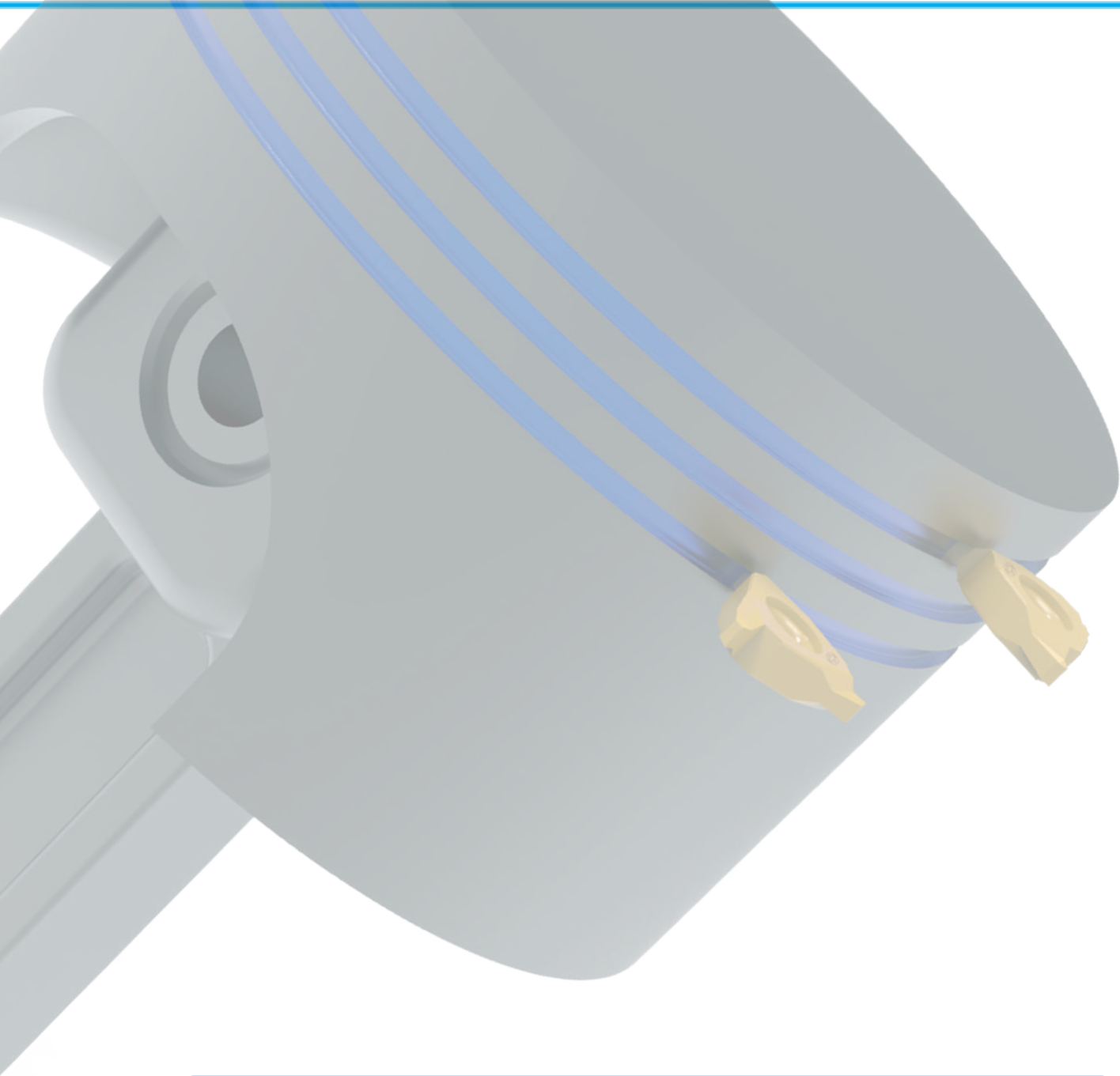

SEGMAN UCU BİLGİ ALMA FORMU
INFORMATION REQUEST FORM FOR RING INSERTS
INFORMATIONSFÖRMULAR FÜR RINGEINSÄTZE

W :		A technical drawing showing the cross-section of a ring insert. The insert is a trapezoidal shape with a top width 'W', a bottom width, and a height 'T'. The top corners are rounded with a radius 'R'. The bottom corners are also rounded with a radius 'R1'. The bottom edge is angled at a angle 'beta'.
R :		
R1 :		
β :		

BROŞ

BROŞ ÇEKME UÇLARI ve TAKIMLARI
BROACHING INSERTS and TOOLHOLDERS
WENDESCHNEIDPLATTEN UND WERKZEUGHALTER FÜR
DIE NUTBEARBEITUNG



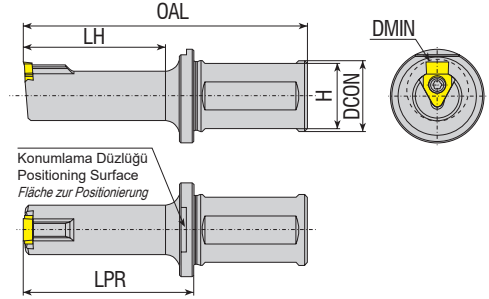

Takım Kodu Ordering Code Bestell-Bezeichnung	Stok Stock Lager	Takım Ölçüleri (mm) Dimension (mm) Abmessung (mm)						Kesici Uç Insert Wendescheidplatte	Yedek Parçaları / Spare Parts / Ersatzteile	
		DMIN	LH	DCON	OAL	LPR	H		Sıkma Vidası Screw Schraube	Tork Anahtar Torx Key Torx-Schlüssel
new ABT-B41-D14-Y25-L90-I040	●	14	40	25	90	50	23	B41...	4015-M4x11	80-T15
ABT-B41-D17-Y25-L90-I040	●	17	40	25	90	50	23			
ABT-B41-D17-Y25-L105-I065	●	17	65	25	105	75	23			
ABT-B41-D22-Y25-L100-I050	●	22	50	25	100	60	23			
ABT-B41-D22-Y25-L125-I070	●	22	70	25	125	80	23			
ABT-B42-D30-Y32-L100-I050	●	30	50	32	100	60	30	B42...	1020-M5x14	80-T20
ABT-B42-D30-Y32-L125-I075	●	30	75	32	125	85	30			
ABT-B42-D30-Y32-L170-I110	●	30	110	32	170	120	30			
ABT-B42-D38-Y32-L100-I050	●	38	50	32	100	60	30			
ABT-B42-D38-Y32-L125-I075	●	38	75	32	125	85	30			
ABT-B42-D40-Y32-L100-I050	●	40	50	32	100	60	30			
ABT-B42-D40-Y32-L125-I075	●	40	75	32	125	85	30			

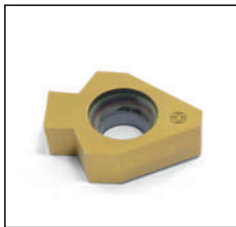

DIN138 (Tolerans C11) torna ve freze tezgahlarında broş çekme uçları.
DIN138 (Tolerance C11) inserts for keyway broaching on lathe and milling machines.
DIN 138 (Toleranz C11) Wendepplatten für Keilnutenfertigung auf Dreh- und Fräsmaschinen

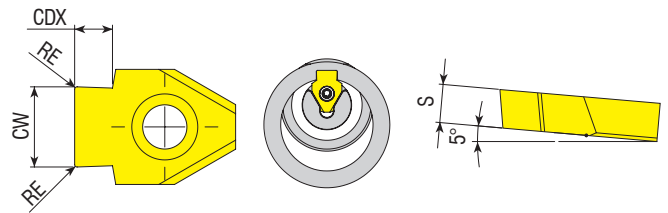

Uç Kodu Insert Code Wendepplatten-Bezeichnung	Stok Stock Lager	Uç Ölçüleri (mm) Insert Dimension (mm) Abmessung (mm)					UYUMLU TAKIM / COMPATIBLE TOOLHOLDER / KOMPATIBLES WERKZEUG
		CW	RE	CDX	S	DMIN	
B41.00.0612.085.VP3001	●	6.12	0.85	2.6	4.0	22	ABT-B41-D22...
B41.00.0713.085.VP3001	●	7.13	0.85	3.3	4.0	22	
B41.00.0813.105.VP3001	●	8.13	1.05	3.4	4.0	22	
B42.00.1013.105.VP3001	●	10.13	1.05	4.2	6.0	30	ABT-B42-D30...
B42.00.1215.135.VP3001	●	12.15	1.35	5.1	6.0	38	ABT-B42-D38...
B42.00.1215.175.VP3001	●	12.15	1.75	6.6	6.0	38	
B42.00.1215.225.VP3001	●	12.15	2.25	8.5	6.0	38	

Tipik kesme şartları / Typical cutting conditions Tipik kesme şartları / Typical cutting conditions / Standard-Schneidbedingungen: İlerleme (Vf): 3000-8000 mm/dak (min)
/ Paso (ap): 0.02-0.08 mm / Vorschub (Vf): 3000-8000 mm/min

R: Sağ / Right / Rechts L: Sol / Left / Links

● Stokta / In Stock / Auf Lager ○ Stokta Yok / Non Stock Item / Kein Lagerartikel, Lieferzeit auf Anfrage

Sipariş Örneği/Ordering Example/Bestellbeispiel
1 ad./pcs./stück ABT-B41-D14-Y25-L90-I040



*DIN138 (Tolerans D10) torna ve freze tezgahlarında broş çekme uçları.
 DIN138 (Tolerance D10) inserts for keyway broaching on lathe and milling machines.
 DIN 138 (Toleranz D10) Wendeplatten für Keilnutenfertigung auf Dreh- und Fräsmaschinen*

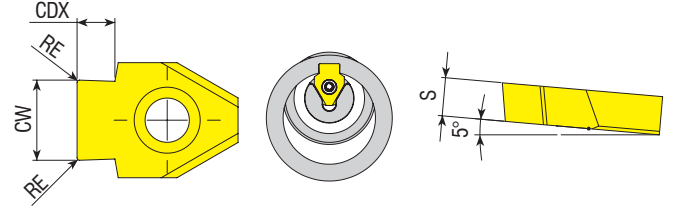

Uç Kodu Insert Code Wendeplatten-Bezeichnung	Stok Stock Lager	Uç Ölçüleri (mm) Insert Dimension (mm) Abmessung (mm)					UYUMLU TAKIM / COMPATIBLE TOOLHOLDER / KOMPATIBLES WERKZEUG
		CW	RE	CDX	S	DMIN	
B41.00.0407.012.VP3001	○	4.07	0.12	2.2	4.0	14	ABT-B41-D14...
B41.00.0507.020.VP3001	○	5.07	0.2	2.9	4.0	14	
B41.00.0607.020.VP3001	○	6.07	0.2	3.5	4.0	17	
B41.00.0808.020.VP3001	○	8.08	0.2	4.3	4.0	22	ABT-B41-D22...
B42.00.1008.030.VP3001	○	10.08	0.3	4.4	6.0	30	ABT-B42-D30...
B42.00.1210.030.VP3001	○	12.10	0.3	5.9	6.0	38	ABT-B42-D38...
B42.00.1410.030.VP3001	○	14.10	0.3	6.8	6.0	40	ABT-B42-D40...

Tipik kesme şartları / Typical cutting conditions / Tipik kesme şartları / Typical cutting conditions / Standard-Schneidbedingungen: İlerleme (Vf): 3000-8000 mm/dak (min)
 / Paso (ap): 0.02-0.08 mm / Vorschub (Vf): 3000-8000 mm/min

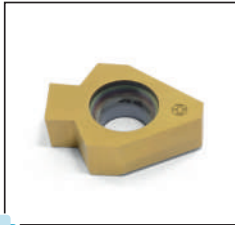

*DIN6885 (Tolerans P9) torna ve freze tezgahlarında broş çekme uçları.
 DIN6885 (Tolerance P9) inserts for keyway broaching on lathe and milling machines.
 DIN6885 (Toleranz P9) Wendeplatten für Keilnutenfertigung auf Dreh- und Fräsmaschinen*

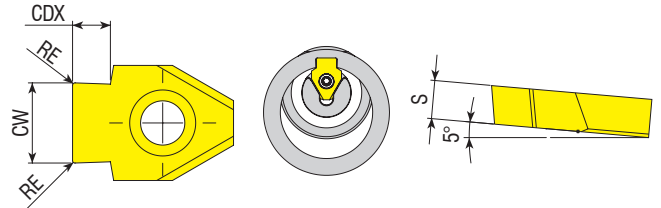

Uç Kodu Insert Code Wendeplatten-Bezeichnung	Stok Stock Lager	Uç Ölçüleri (mm) Insert Dimension (mm) Abmessung (mm)					UYUMLU TAKIM / COMPATIBLE TOOLHOLDER / KOMPATIBLES WERKZEUG
		CW	RE	CDX	S	DMIN	
B41.00.0498.020.VP3001	●	4.98	0.20	2.7	4.0	17	ABT-B41-D17
B41.00.0598.020.VP3001	●	5.98	0.20	3.4	4.0	17	
B41.00.0798.020.VP3001	●	7.98	0.20	4.1	4.0	22	ABT-B41-D22
B42.00.0998.030.VP3001	●	9.98	0.30	4.2	6.0	30	ABT-B42-D30
B42.00.1197.030.VP3001	●	11.97	0.30	5.7	6.0	38	ABT-B42-D38
B42.00.1397.030.VP3001	●	13.97	0.30	6.8	6.0	40	ABT-B42-D40

Tipik kesme şartları / Typical cutting conditions / Standard-Schneidbedingungen: İlerleme (Vf): 3000-8000 mm/dak (min) / Paso (ap): 0.02-0.08 mm / Vorschub (Vf): 3000-8000 mm/min

Sipariş Örneği/Ordering Example/Bestellbeispiel
 1 ad./pcs./stück B41.00.0407.012.VP3001



DIN6885 (Tolerans JS9) torna ve freze tezgahlarında broş çekme uçları.
DIN6885 (Tolerance JS9) inserts for keyway broaching on lathe and milling machines.
DIN6885 (Toleranz JS9) Wendeplatten für Keilnutenfertigung auf Dreh- und Fräsmaschinen

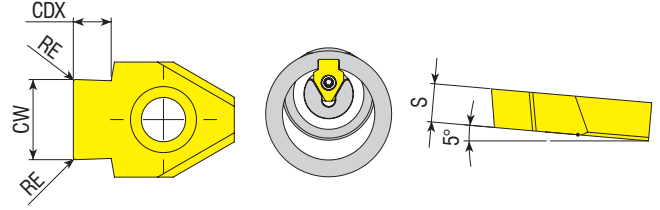

Uç Kodu Insert Code Wendeplatten-Bezeichnung/Geidplatte	Stok Stock Lager	Uç Ölçüleri (mm) Insert Dimension (mm) Abmessung (mm)					UYUMLU TAKIM / COMPATIBLE TOOLHOLDER / KOMPATIBLES WERKZEUG
		CW	RE	CDX	S	DMIN	
B41.00.0501.020.VP3001	●	5.01	0.20	2.7	4.0	17	ABT-B41-D17 ABT-B41-D22 ABT-B42-D30 ABT-B42-D38 ABT-B42-D40
B41.00.0601.020.VP3001	●	6.01	0.20	3.4	4.0	17	
B41.00.0801.020.VP3001	●	8.01	0.20	4.1	4.0	22	
B42.00.1001.030.VP3001	●	10.01	0.30	4.2	6.0	30	
B42.00.1200.050.VP3001	●	12.00	0.50	8.5	6.0	38	
B42.00.1201.030.VP3001	●	12.01	0.30	5.7	6.0	38	
B42.00.1401.030.VP3001	●	14.01	0.30	6.8	6.0	40	

Tipik kesme şartları / Typical cutting conditions / Standard-Schneidbedingungen: İlerleme (Vf): 3000-8000 mm/dak (min) / Paso (ap): 0.02-0.08 mm / Vorschub (Vf): 3000-8000 mm/min



Torna ve freze tezgahlarında kama kanalı pah kırma uçları.
Inserts for keyway chamfering on lathe and milling machines.
Wendeschnidplatten zum Anfasen von Keilnuten auf Dreh- und Fräsmaschinen

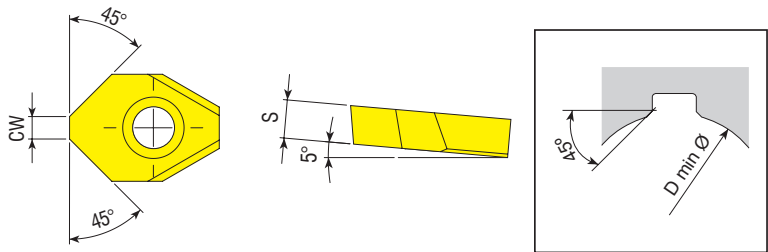

Uç Kodu Insert Code Wendeplatten-Bezeichnung/Geidplatte	Stok Stock Lager	Uç Ölçüleri (mm) Insert Dimension (mm) Abmessung (mm)			UYUMLU TAKIM / COMPATIBLE TOOLHOLDER / KOMPATIBLES WERKZEUG
		DMIN	CW	S	
B41.00.0150.CH.VP3001	●	17	1.5	4.0	ABT-B41-D17
B41.00.0300.CH.VP3001	●	22	3.0	4.0	ABT-B41-D22
B42.00.0600.CH.VP3001	●	30	6.0	6.0	ABT-B42-D30

Tipik kesme şartları / Typical cutting conditions / Standard-Schneidbedingungen: İlerleme (Vf): 3000-8000 mm/dak (min) / Paso (ap): 0.02-0.08 mm / Vorschub (Vf): 3000-8000 mm/min

R: Sağ / Right / Rechts L: Sol / Left / Links

● Stokta / In Stock / Auf Lager ○ Stokta Yok / Non Stock Item / Kein Lagerartikel, Lieferzeit auf Anfrage

Sipariş Örneği/Ordering Example/Bestellbeispiel
1 ad./pcs./stück B41.00.0501.020.VP3001

BROŞ ÖZEL ÇÖZÜMLER

BROACHING SPECIAL SOLUTIONS

NUTBEARBEITUNG SPEZIELLE LÖSUNGEN

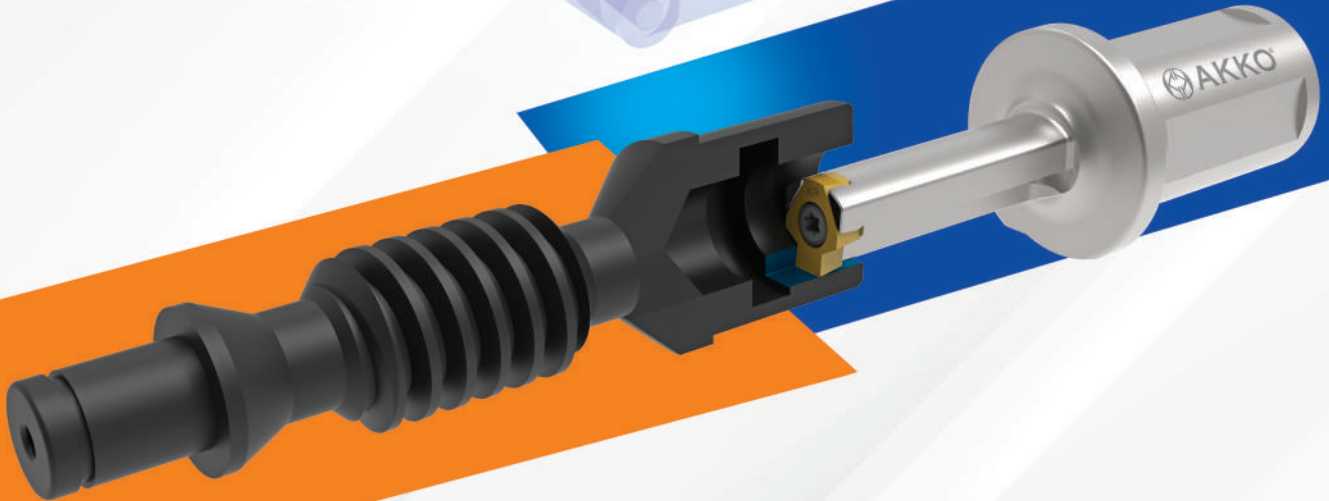
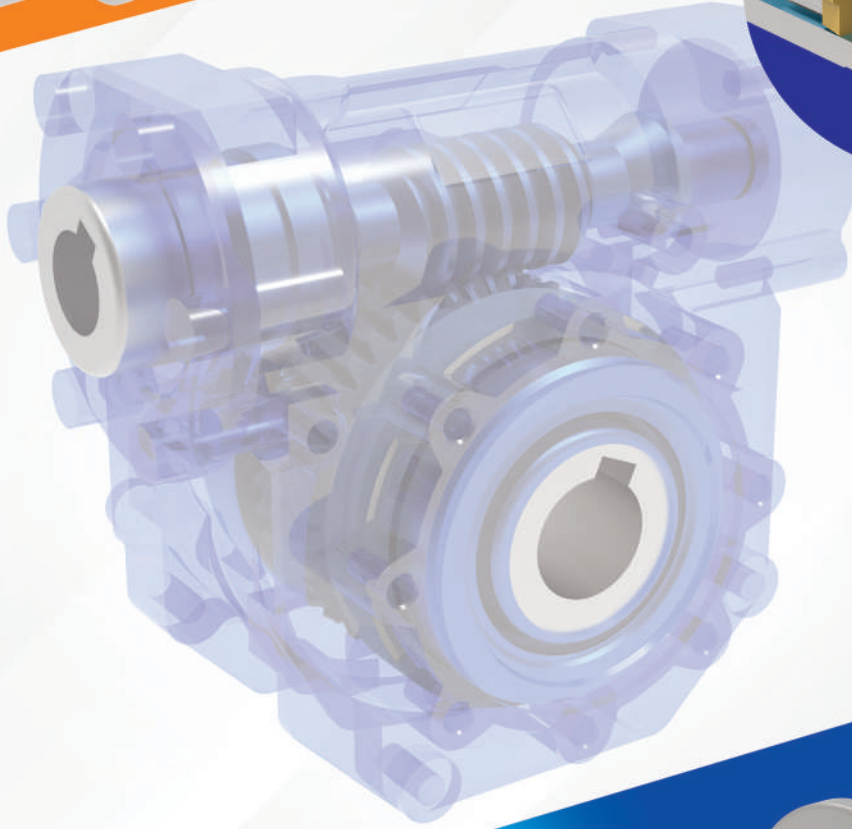
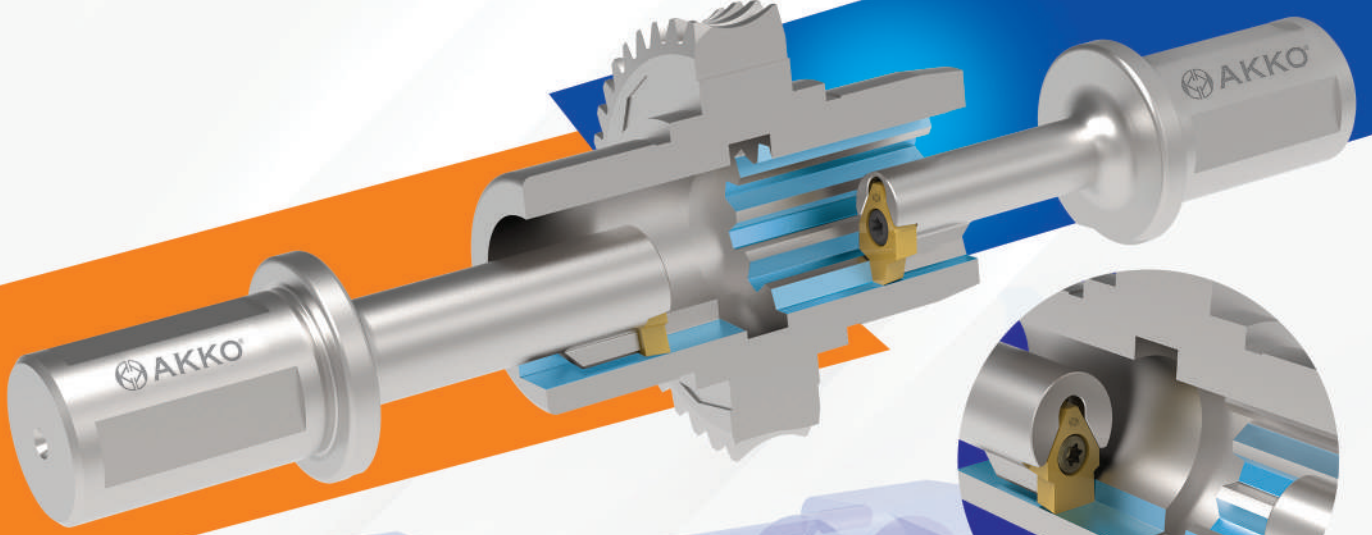

PROFİL VERİLMİŞ UÇLAR / PROFILED INSERTS / PROFIL-WENDESCHNEIDPLATTEN
ÖRNEK PROFİLLER / EXAMPLES OF PROFILES / BEISPIELE FÜR PROFILE



Profil uçlar müşterilerimizin özel taleplerine göre üretilmektedir.
Profiled inserts are manufactured according to customer special requirements.
Die Profil-Wendeschneidplatten werden nach Kundenwunsch gefertigt.

1



Üretmemizi istediğiniz Uçun teknik özelliklerini veya bir örneğini bize gönderin.
Send us the technical specifications or a sample of the insert you want to produce.
Bitte lassen Sie uns ein exemplar sowie die technischen Einzelheiten der gewünschten Wendeschneidplatte zukommen.



2

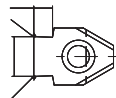

Sizin için bir teklif hazırlayalım.
We prepare an offer for you.
Wir werden für Sie ein Angebot vorbereiten.



3



Üretimi yapıp size göndereyim.
We produce it and ship it to you.
Wir werden es produzieren und Ihnen ausliefern.

BROŞ UCU BİLGİ ALMA FORMU / BROACHING INSERT INFORMATION FORM / INFORMATIONSBLATT FÜR DIE WENDESCHNEIDPLATTE DER NUTBEARBEITUNG

Broş ve Delik Ölçüleri / Dimension of Bore / Maße von Bohrungsdurchmesser und Nuten

b				
t				
r				
d/min*				
İş Parçası Malzemesi Work Material Werkstückmaterial				
Tolerans Grubu / Tolerance Group / Toleranzgruppe				
C11	P9	JS9	CUSTOM	

BROŞ ÖZEL ÇÖZÜMLER
BROACHING SPECIAL SOLUTIONS
NUTBEARBEITUNG SPEZIELLE LÖSUNGEN

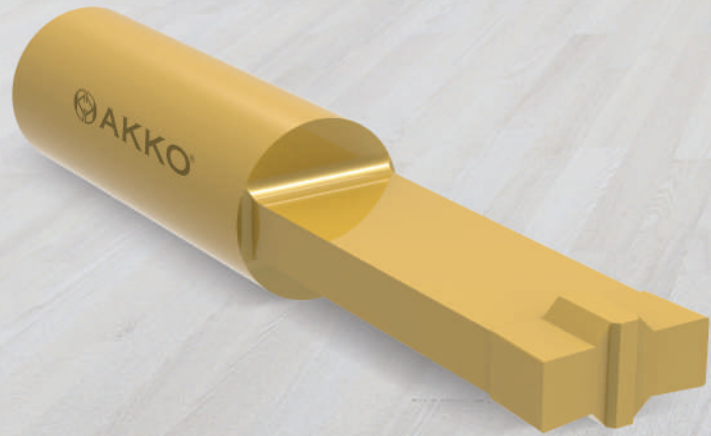
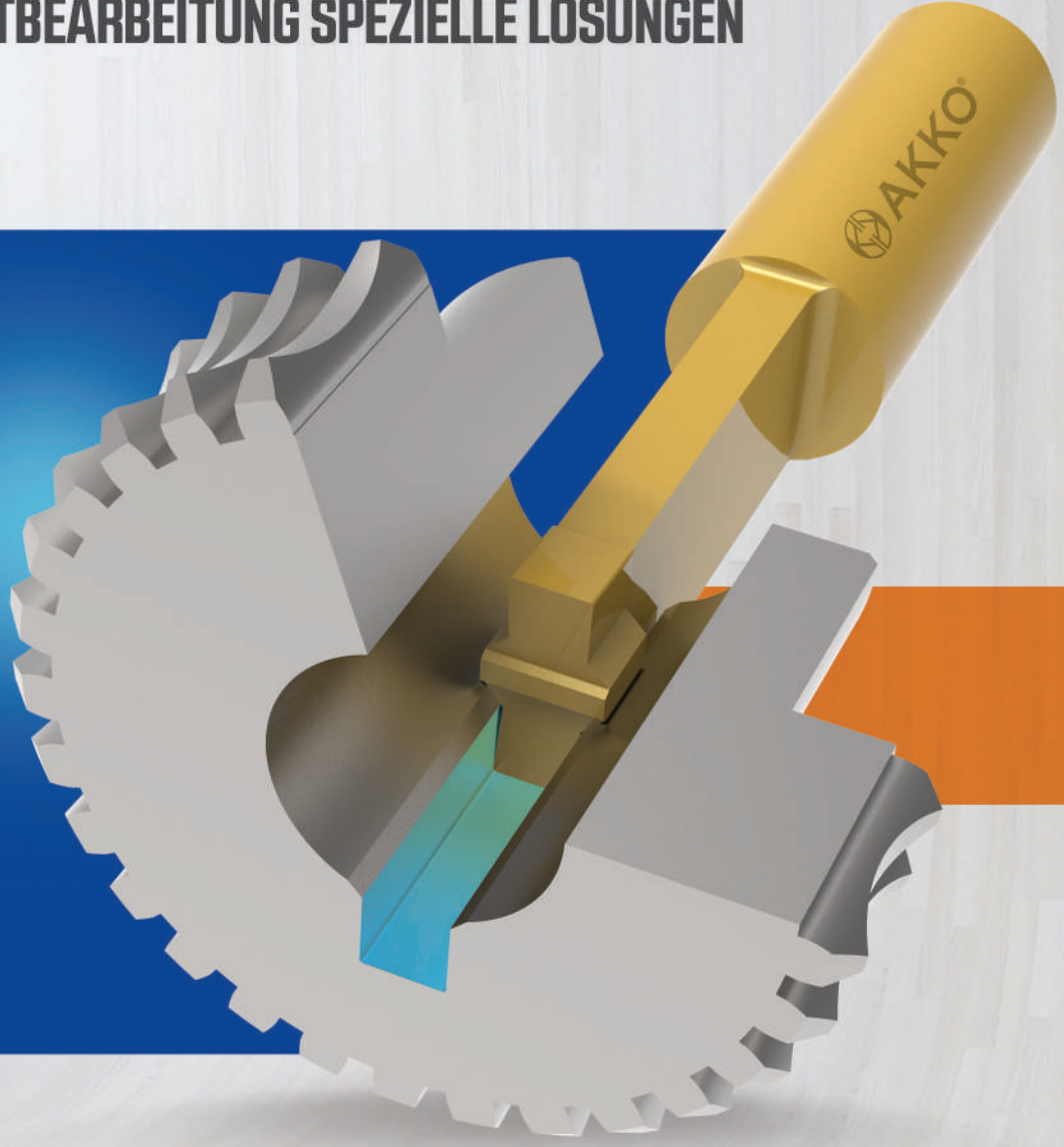

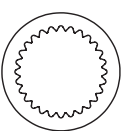
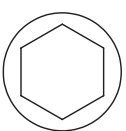
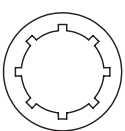
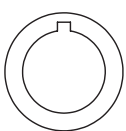

TULIP HEADS

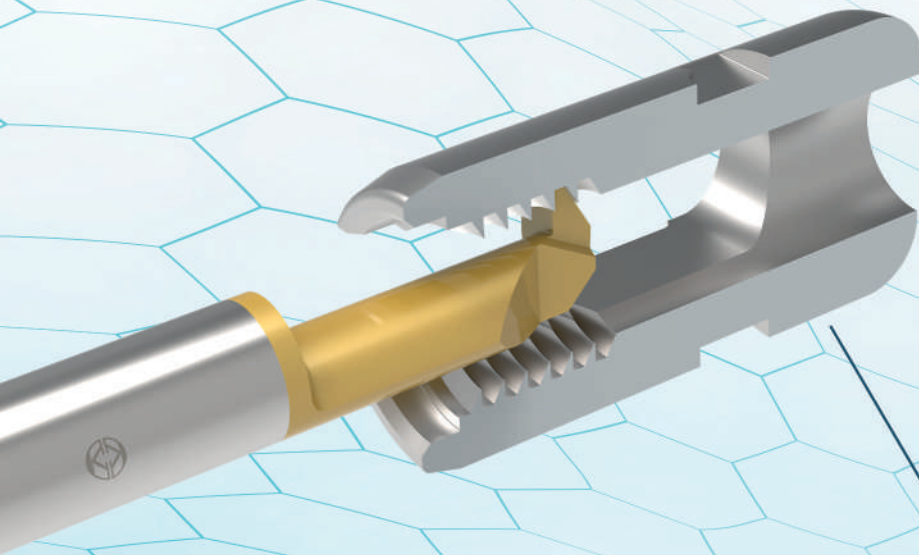
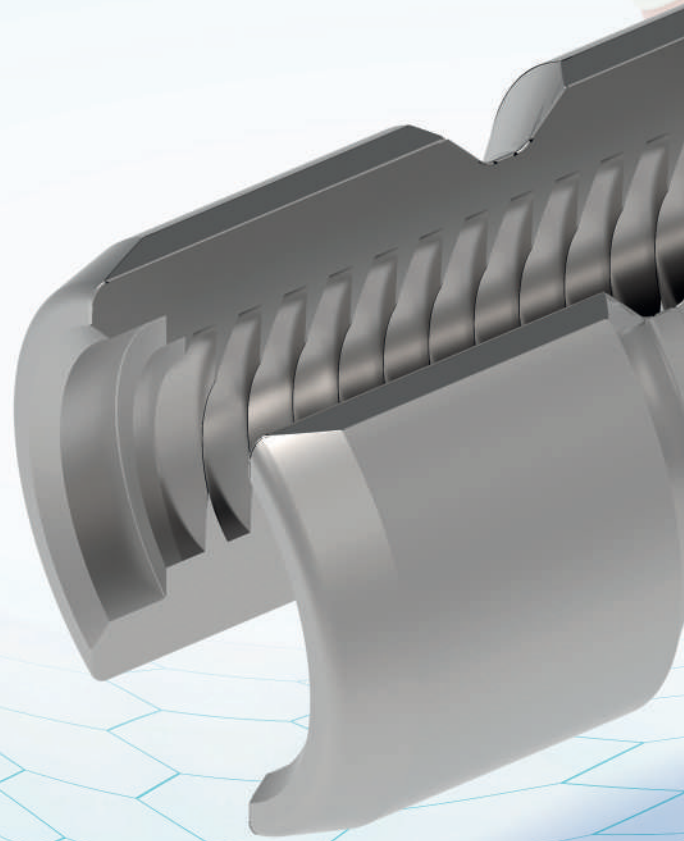
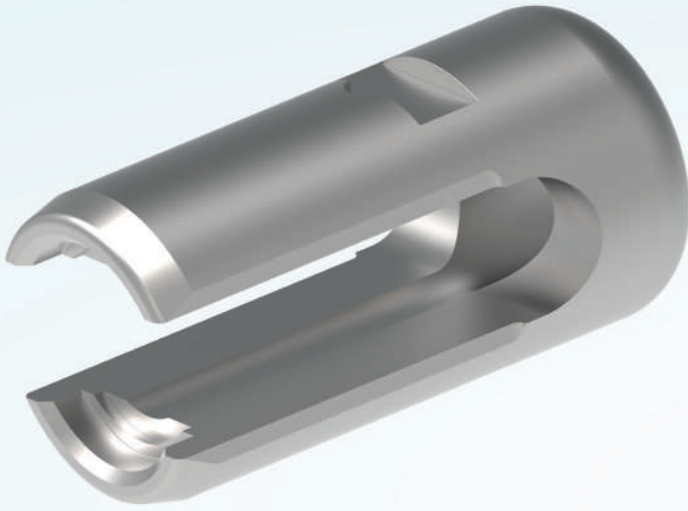

DIŞ AÇMA
THREADING
GEWINDE

DELİK İÇİ
TORNALAMA

BORING
BOHREN

ÖZEL FORMA AÇMA

SPECIAL FORMING
SONDER FORM BEARBEITUNG

 **AKKO®**

IMPLANT NUT

DIŞ AÇMA
THREADING
GEWINDE

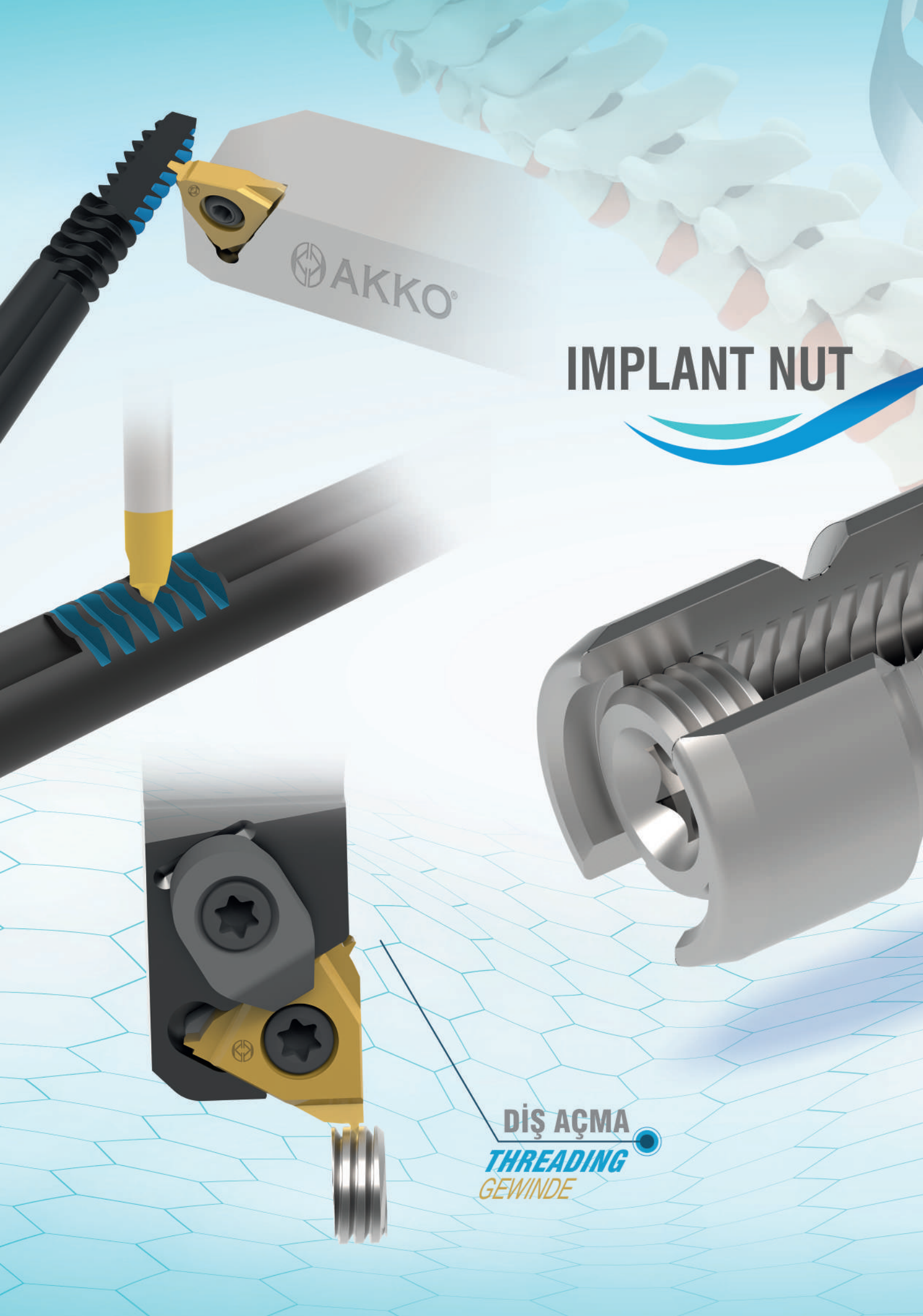

ALIN ÖZEL FORM
**FACE SPECIAL
FORMING**
ALIN SONDERFORM

ALYAN PUNCH

ALLEN PUNCH
*WINKELSCHRAUBENDEHER
WERKZEUGE*

WHIRLING

WHIRLING

WENDESCHNEIDPLATTEN

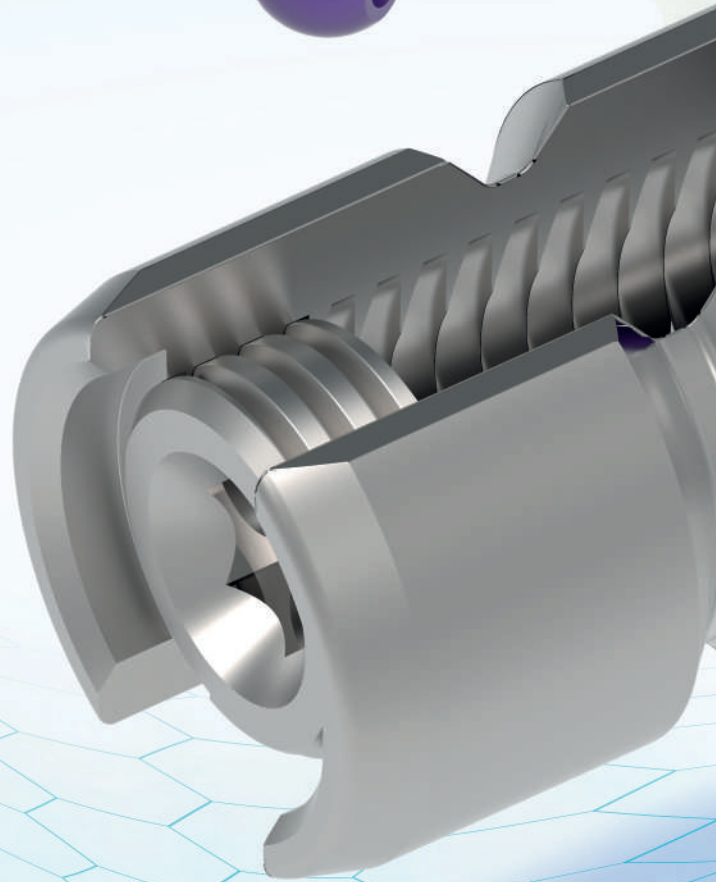
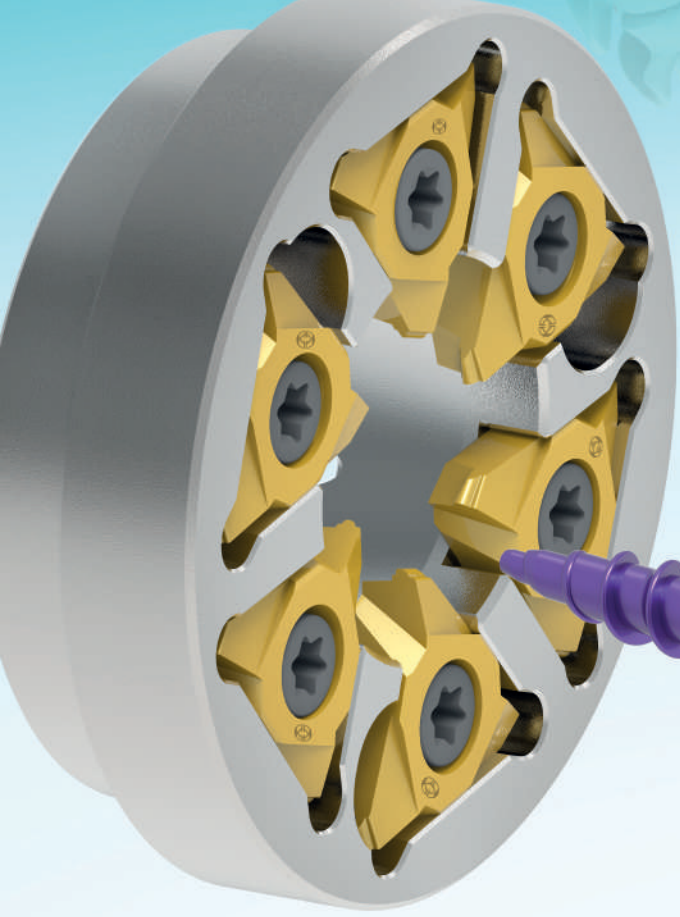

ALYAN / PUNCH - KAZIMA

ALLEN / PUNCH - BROACH

*WINKELSCHRAUBENDEHER
WERKZEUGE*

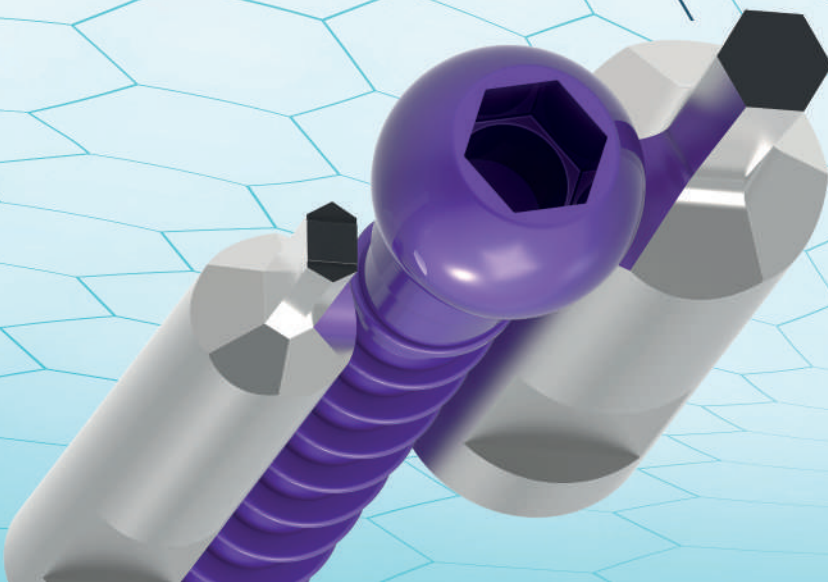

IMPLANT SCREW

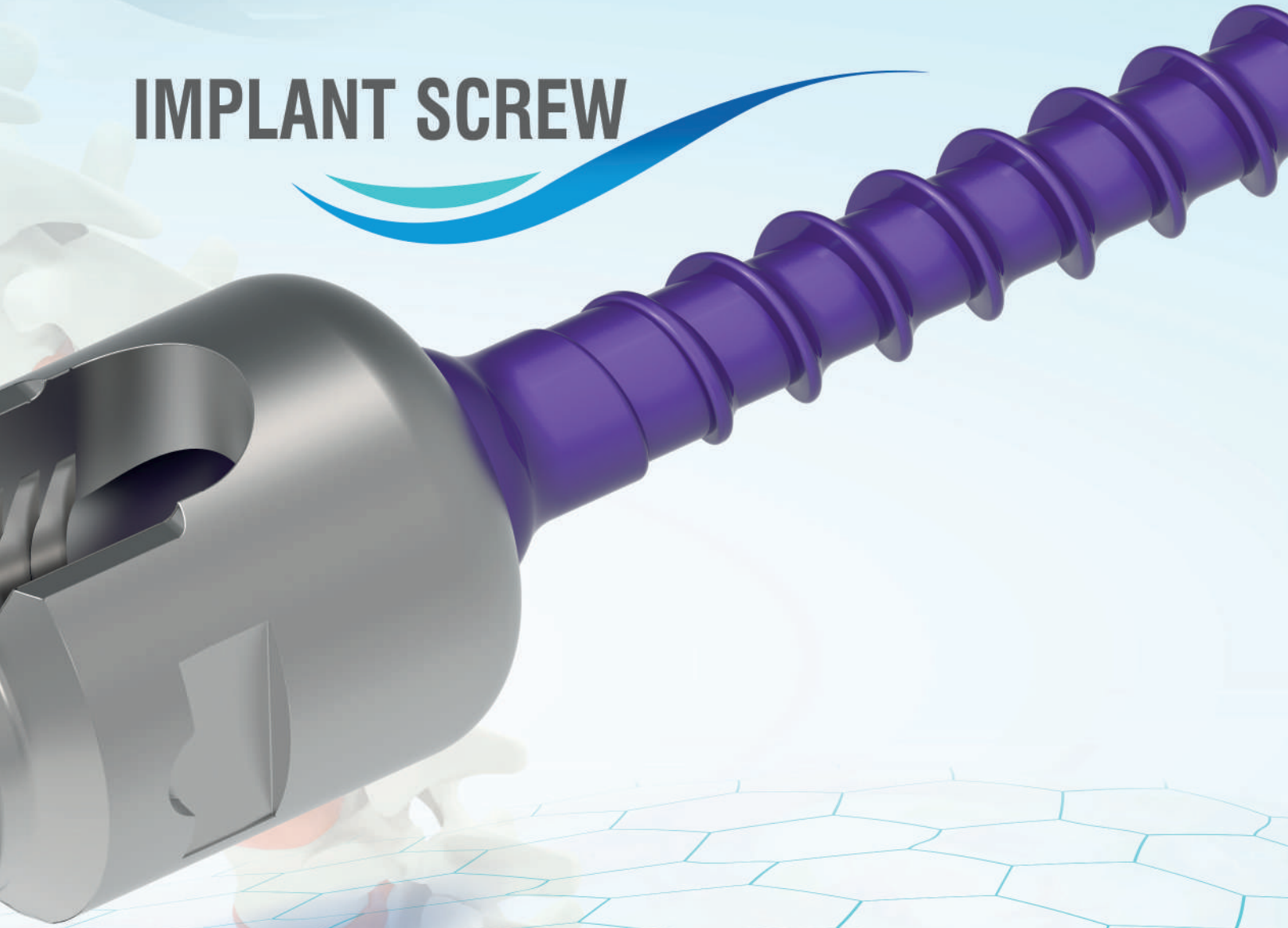

TORX / PUNCH - KAZIMA

TORX / PUNCH - BROACH
WINKELSCHRAUBENDREHER - RING

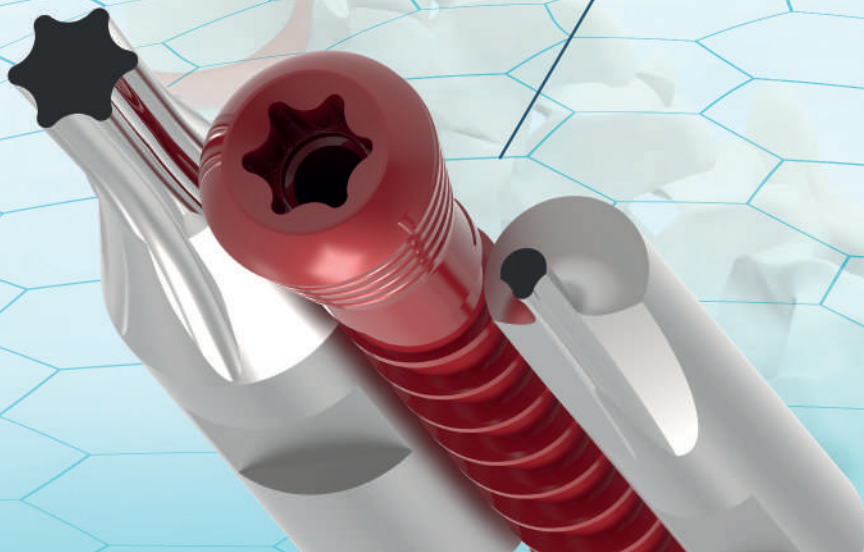

WHIRLING

WHIRLING UÇLARI ve TAKIMLARI

WHIRLING INSERTS and TOOLHOLDERS

WENDESCHNEIDPLATTEN UND WERKZEUGHALTER ZUM
GEWINDEWIRBELN



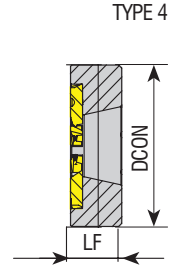
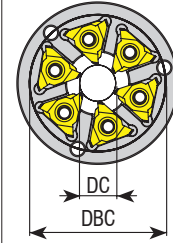
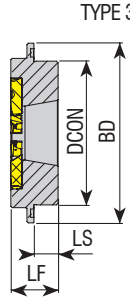
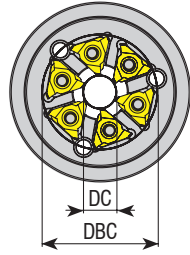
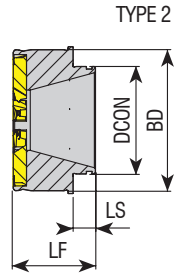
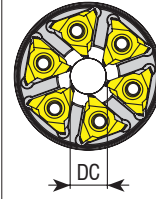
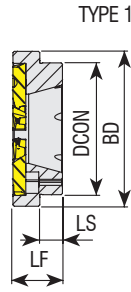
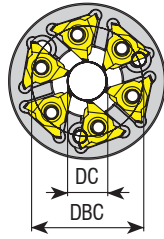
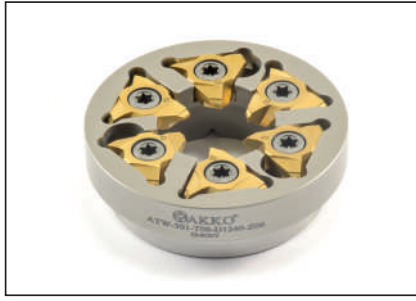

Makine Machine Maschine	Tahrikli WHIRLING Ünitesi Aggregate WHIRLING Unit Wirbelspindel	WHIRLING Ring Kodu WHIRLING Ring Code Wirbelring	Stok Stock Lager	Takım Ölçüleri (mm) Dimension (mm) Abmessung (mm)								Kesici Uç Insert Wendeschneidplatte	Yedek Parçaları / Spare Parts / Ersatzteile	
				ZEPF	DC	DCON	DBC	BD	LS	LF	TYPE		Sıkma Vidası Screw Schraube	Tork Anahtar Torx Key Torx-Schlüssel
STAR	5914 72 00/68172	ATW-301-T09-D1240-Z06	●	6	12	40	33	47	7	15	1			
CITIZEN	BTW1000	ATW-302-T09-D1233-Z06	○	6	12	33	40	47	4	18.5	-			
	GSW101	ATW-303-T09-D0620-Z06	○	6	6	20	26	35	3.2	15	1			
	MWS101/KSW101	ATW-304-T09-D1240-Z06	○	6	12	40	32.5	46	2.5	15.5	1			
	LSW101/BSW215/ LSW215315													
	LSW424													
TORNOS	306101/307087	ATW-306-T09-D1240-Z06	●	6	12	40	31	57	3.5	15	-			
	417617	ATW-307-T09-D1250-Z06	○	6	12	50	40	67	3.5	15.4	-			
WTO	TN762004	ATW-308-T09-D1142-Z06	●	6	11	31.97	-	42	6.7	24.7	2			
	TN762006	ATW-309-T09-D2054-Z08	○	8	20	56.5	-	54	1.5	13.8	2			
TSUGAMI	3234 Y342	ATW-310-T09-D1252-Z06	●	6	12	52	42	65	8.7	17	3			
	3268 Y452	ATW-311-T09-D1252-Z06	○	6	12	52	44	52	10	10	3			
	3268 Y271	ATW-312-T09-D1252-Z06	○	6	12	52	38	54	6	19	3			
	3214 Y342	ATW-313-T09-D1650-Z06	○	6	16	50	40	62	8.5	20	3			
	3234 Y342	ATW-314-T09-D2052-Z06	○	6	20	52	42	65	8.7	17	3			
	3281-Y451	ATW-316-T09-D1252-Z06	●	6	12	52	44	52	-	17	4			
new HANWHA	MADAULA	ATW-315-T09-D0937-Z06	○	6	9.4	-	-	54.9	20.8	38.3	2			
		ATW-315-T09-D1245-Z06	●	6	12	45	-	56	8.5	15	1			

R: Sağ / Right / Rechts L: Sol / Left / Links

● Stokta / In Stock / Auf Lager ○ Stokta Yok / Non Stock Item / Kein Lagerartikel, Lieferzeit auf Anfrage

Sipariş Örneği/Ordering Example/Bestellbeispiel

1 ad./pcs./stück ATW-301-T09-D1240-Z06

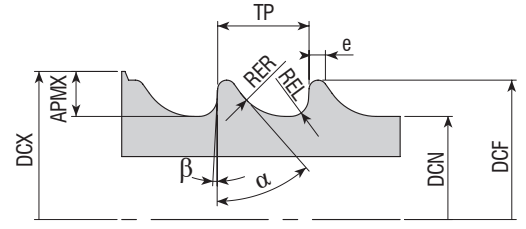
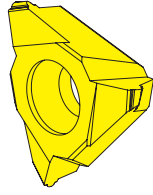
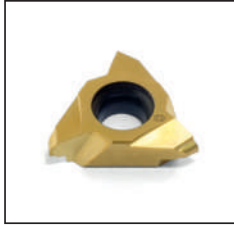

Uç Kodu Insert Code Wendepplatten-Bezeichnung	Kalite Grade Sorte		Standart ISO5835	Uç Ölçüleri (mm) Insert Dimension (mm) Abmessung (mm)									
	VK15U	VK15U01		TP	e	DCF	DCN	RER	REL	α	β	APMX	DCX
T09.HA150.D12	●	●	HA1.5	0.5	0.1	1.35 to 1.5	1.0 to 1.1	0.30	0.1	35°	3°	4	9
T09.HA200.D12	●	●	HA2.0	0.6	0.1	1.85 to 2.0	1.2 to 1.3	0.40	0.1	35°	3°	4	9
T09.HA270.D12	●	●	HA2.7	1	0.1	2.55 to 2.7	1.75 to 1.9	0.60	0.2	35°	3°	4	9.5
T09.HA350.D12	●	●	HA3.5	1.25	0.1	3.35 to 3.5	2.25 to 2.4	0.80	0.2	35°	3°	4	10
T09.HA400.D12	●	●	HA4.0	1.5	0.1	3.85 to 4.0	2.75 to 2.9	0.80	0.2	35°	3°	4	10.5
T09.HA450.D12	●	●	HA4.5	1.75	0.1	4.35 to 4.5	2.85 to 3.0	1.00	0.3	35°	3°	4	11
T09.HA500.D12	●	●	HA5.0	1.75	0.1	4.85 to 5.0	3.35 to 3.5	1.00	0.3	35°	3°	4	11
T09.HB400.D12	●	●	HB4.0	1.75	0.1	3.85 to 4.0	1.75 to 1.9	0.80	0.3	25°	5°	4	9.5
T09.HB650.D12	●	●	HB6.5	2.75	0.2	6.35 to 6.5	2.85 to 3.0	1.20	0.8	25°	5°	4	11

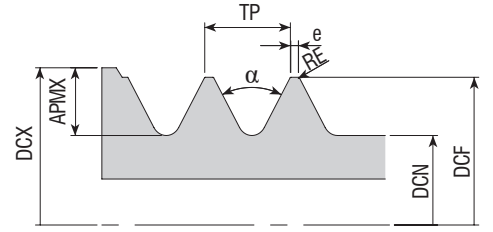
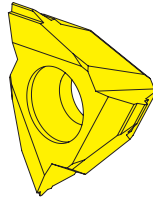
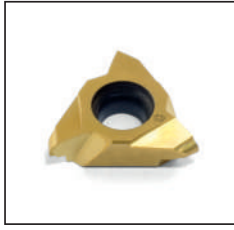

Uç Kodu Insert Code Wendepplatten-Bezeichnung	Kalite Grade Sorte		Standart ISO9268	Uç Ölçüleri (mm) Insert Dimension (mm) Abmessung (mm)							
	VK15U	VK15U01		TP	e	DCF	DCN	α	RE	APMX	DCX
T09.HC290.D12	○	○	HC2.9	1.06	0.1	2.79 to 2.90	2.03 to 2.18	60°	0.01	4	10.5
T09.HC350.D12	○	○	HC3.5	1.27	0.1	3.43 to 3.53	2.51 to 2.64	60°	0.01	4	11
T09.HC390.D12	○	○	HC3.9	1.27	0.1	3.78 to 3.91	2.77 to 2.92	60°	0.01	4	11.5
T09.HC420.D12	○	○	HC4.2	1.27	0.1	4.09 to 4.22	2.95 to 3.25	60°	0.01	4	12

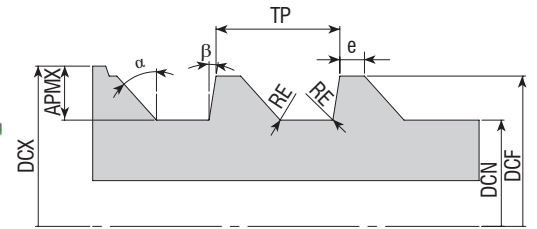
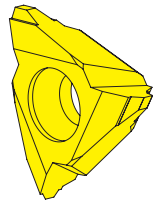
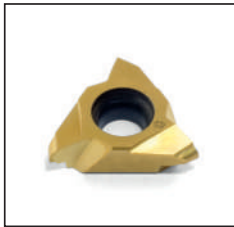

Uç Kodu Insert Code Wendepplatten-Bezeichnung	Kalite Grade Sorte		Standart ISO9268	Uç Ölçüleri (mm) Insert Dimension (mm) Abmessung (mm)								
	VK15U	VK15U01		TP	e	DCF	DCN	RE	α	β	APMX	DCX
T09.HD400.D12	○	○	HD4.0	1.59	0.1	3.97 to 4.03	2.89 to 2.95	0.01	45°	10°	4	11.5
T09.HD450.D12	○	○	HD4.5	2.18	0.1	4.47 to 4.53	2.89 to 2.95	0.01	45°	10°	4	12

R: Sağ / Right / Rechts L: Sol / Left / Links

● Stokta / In Stock / Auf Lager ○ Stokta Yok / Non Stock Item / Kein Lagerartikel, Lieferzeit auf Anfrage

Sipariş Örneği/Ordering Example/Bestellbeispiel

1 ad./pcs./stück T09.HA150.D12

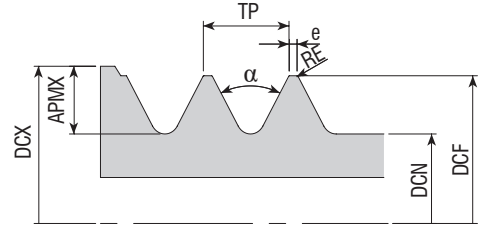
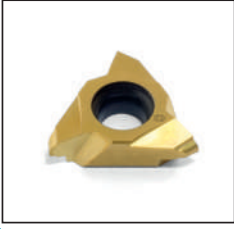

Uç Kodu Insert Code Wendeplatten-Bezeichnung	Kalite Grade Sorte		Standart DIN13	Uç Ölçüleri (mm) Insert Dimension (mm) Abmessung (mm)						
	VK15U	VK15U01		TP	DCF	DCN	a	RE	APMX	DCX
T09.M200.D12	●	●	M2	0.4	2	1.509	60	0.048	4	9
T09.M250.D12	●	●	M2.5	0.45	2.5	1.928	60	0.055	4	9.5
T09.M300.D12	●	●	M3	0.5	3	2.387	60	0.062	4	10
T09.M350.D12	●	●	M3.5	0.6	3.5	2.744	60	0.077	4	8.5
T09.M400.D12	●	●	M4.0	0.7	4	3.141	60	0.091	4	11
T09.M500.D12	●	●	M5.0	0.8	5	4.019	60	0.105	4	11.5
T09.M600.D12	●	●	M6.0	1	6	4.773	60	0.134	4	12.5
T09.M700.D12	●	●	M7.0	1	7	5.753	60	0.134	4	13.5
T09.M800.D12	●	●	M8.0	1.25	8	6.446	60	0.17	4	14

Kesme başlangıç pozisyonu
Cutting Start Position
Startposition Schneidvorgang

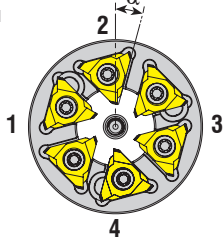

Y Eksen
Y Axis
Y Ocb

İş parçası dönüş yönü
Turning Direction of Workpiece
Drehrichtung Werkstück

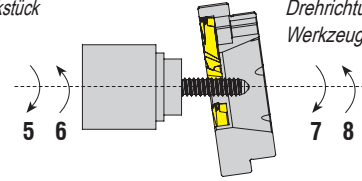

WHIRLING ünitesi dönüş yönü
Turning Direction of WHIRLING unit
Drehrichtung Gewindewirbel
Werkzeug

Makine Özellikleri Machine Specifications Angaben zur Maschine		Malzeme Özellikleri Material Specifications Material Besonderheiten	
Makine Üreticisi Machine Manufacturer Maschinenhersteller		Malzeme (DIN, AISI v.b.) Material (DIN, AISI etc.) Material DIN, AISI etc.	
Makine Modeli Machine Model Maschinenbezeichnung		Ham Malzeme Çapı Raw Material Diameter Rohmaterial Durchmesser	
Tahrikli WHIRLING Ünitesi Üreticisi Live Tool Manufacturer Hersteller angetriebene Werkzeuge		Diş Profili Thread Profile Gewindeprofil	
Tahrikli WHIRLING Ünitesi Aggregate WHIRLING Unit Wirbelspindel		Profil Teknik Resmi Profile Technical Drawing Profilzeichnung	
Y - Eksen Y - Axis Y - Achse	Var Exist Ja <input type="checkbox"/>	Yok None Nein <input type="checkbox"/>	Hatve Pitch Steigung
Yüksek Basıncılı Soğutma High Pressure Coolant Hochdruckkühlung	Var Exist Ja <input type="checkbox"/>	Yok None Nein <input type="checkbox"/>	Tek Ağız One Start Eingängig
Kesme Başlangıç Pozisyonu Cutting Start Position Startposition Schneidvorgang	1 <input type="checkbox"/> 2 <input type="checkbox"/> 3 <input type="checkbox"/> 4 <input type="checkbox"/>		İki Ağız Two Starts Zweigängig
WHIRLING Ünitesi Dönüş Yönü Turning Direction of WHIRLING Unit Drehrichtung Gewindewirbel-Werkzeug	5 <input type="checkbox"/> 6 <input type="checkbox"/>		Müşteri Adı / Customer Name / Kundennamen:
İş Parçası Dönüş Yönü Turning Direction of Workpiece Drehrichtung Werkstück	7 <input type="checkbox"/> 8 <input type="checkbox"/>		Yetkili / Responsible Person / Ansprechpartner :
α Açısı α Angle Winkel	Not: Bu açı ürün performansına etki ettiğinden bildirilmesi gerekmektedir. Aksi halinde ring tarafımıza gönderilmelidir. Note: This angle effects the performance of inserts. If doesn't known, tool body should be send to AKKO. Hinweis: Dieser Winkel beeinflusst die Leistung der Wendschneidplatte. Sollte dieser Winkel unbekannt sein, können Sie das Werkzeug zur Fa. AKKO schicken.		
Not / Note / Notizen :			

MINI CUT

MINI CUT TUTUCU VE TAKIMLARI
MINI CUT HOLDERS AND TOOLS
MINI CUT HALTER UND WERKZEUGE

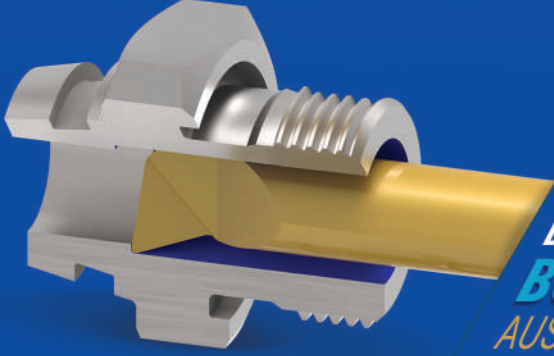

01
DELİK İÇİ TORNALAMA
BORING
AUSDREHEN

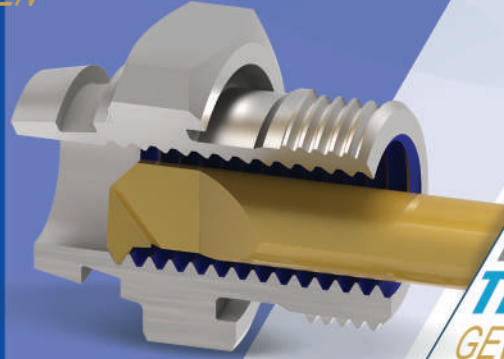

02
DIŞ AÇMA
THREADING
GEWINDEN

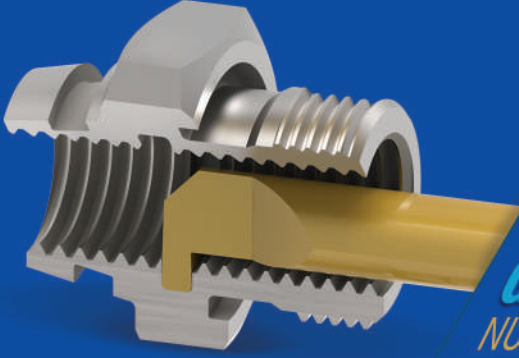

03
KANAL AÇMA
GROOVING
NUTENSTECHEN

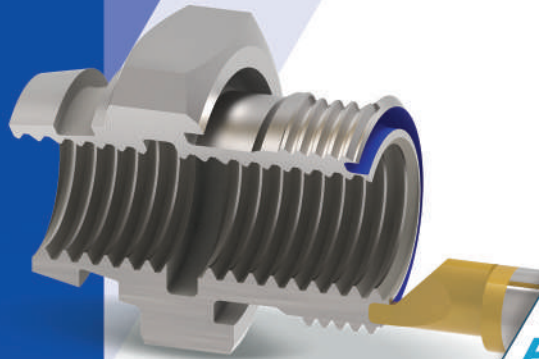

04
ALIN KANAL AÇMA
FACE GROOVING
AXIALSTECHEN



05
MINI CUT TUTUCU
MINI CUT HOLDER
MINI CUT HALTER

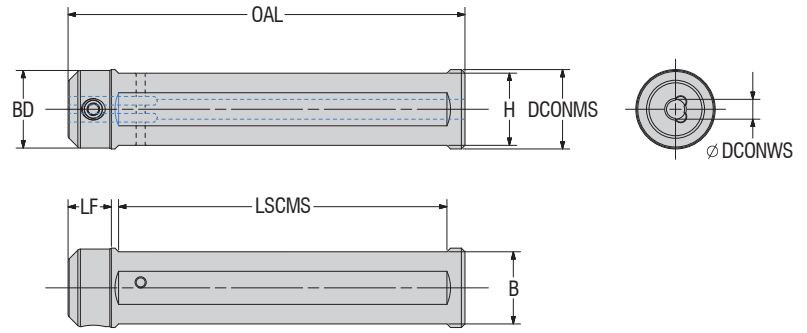

Takım Kodu Ordering Code Bestell-Bezeichnung	Stok Stock Lager	Takım Ölçüleri (mm) Dimension (mm) Abmessung (mm)							
		DCONWS	OAL	DCONMS	BD	LF	LSCMS	B	H
APCH-16-4-L110-H	○	4	110	16	-	-	56	14.8	14.8
APCH-16-5-L110-H	○	5	110	16	-	-	56	14.8	14.8
APCH-16-6-L110-H	○	6	110	16	-	-	56	14.8	14.8
APCH-16-7-L110-H	○	7	110	16	-	-	56	14.8	14.8
APCH-20-4-L110-H	●	4	110	20	19.50	11	92	18.80	18.80
APCH-20-5-L110-H	●	5	110	20	19.50	11	92	18.80	18.80
APCH-20-6-L110-H	●	6	110	20	19.50	11	92	18.80	18.80
APCH-20-7-L110-H	●	7	110	20	19.50	11	91	18.80	18.80
APCH-22-4-L110-H	●	4	110	22	21.50	12	91	20	20
APCH-22-5-L110-H	●	5	110	22	21.50	12	91	20	20
APCH-22-6-L110-H	●	6	110	22	21.50	12	91	20	20
APCH-22-7-L110-H	●	7	110	22	21.50	12	91	20	20
APCH-25-4-L110-H	●	4	110	25	24.50	12	91	23	23
APCH-25-5-L110-H	●	5	110	25	24.50	12	91	23	23
APCH-25-6-L110-H	●	6	110	25	24.50	12	91	23	23
APCH-25-7-L110-H	●	7	110	25	24.50	12	91	23	23

Sipariş Örneği/Ordering Example/Bestellbeispiel
1 ad./pcs./stück APCH-16-4-L110-H

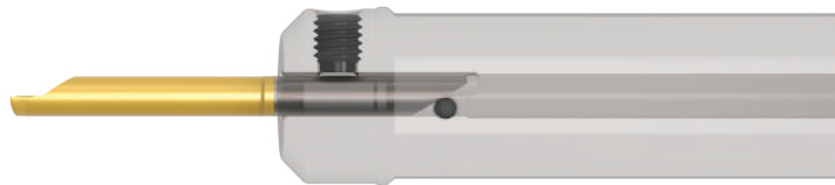
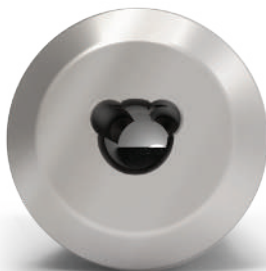

DELİK İÇİ MINI CUT TAKIMLAR
MINI CUT BORING / MINI CUT AUSDREHEN

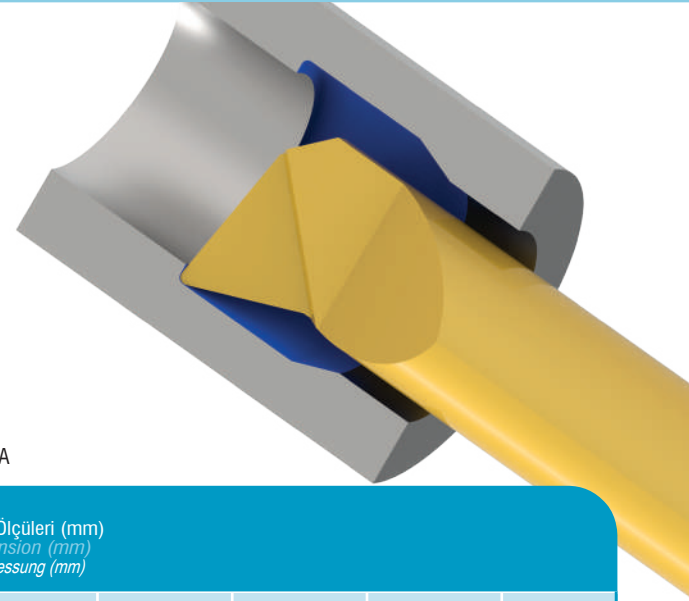
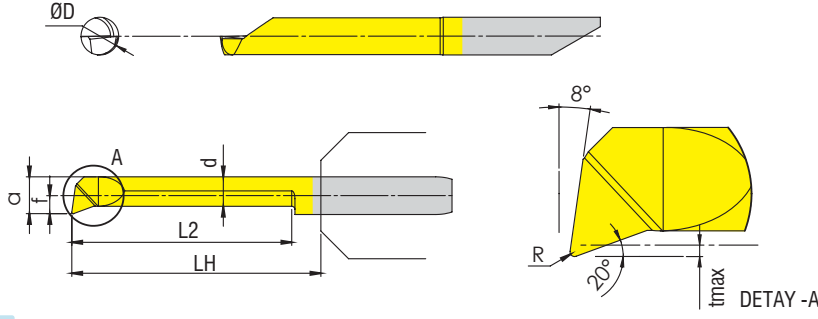

Ürün Kodu
Product Code
Artikelnummer

Takım Ölçüleri (mm)
Dimension (mm)
Abmessung (mm)

	L2	Ødmin	R	a	d	f	LH	tmax	ØD
new APB04.102.015.32	10.20	3.2	0.15	2.95	2.55	1.45	13	0.2	4
new APB04.152.015.32	15.20	3.2	0.15	2.95	2.55	1.45	18	0.2	4
new APB04.203.015.32	20.30	3.2	0.15	2.95	2.55	1.45	23	0.2	4
new APB04.254.015.32	25.40	3.2	0.15	2.95	2.55	1.45	28	0.2	4
new APB04.305.015.32	30.50	3.2	0.15	2.95	2.55	1.45	33	0.2	4
new APB04.356.015.32	35.60	3.2	0.15	2.95	2.55	1.45	38	0.2	4
APB04.102.015	10.2	4.2	0.15	3.95	3.45	1.95	13	0.3	4
APB04.152.015	15.20	4.2	0.15	3.95	3.45	1.95	18	0.3	4
APB04.203.015	20.30	4.2	0.15	3.95	3.45	1.95	23	0.3	4
APB04.254.015	25.40	4.2	0.15	3.95	3.45	1.95	28	0.3	4
APB04.305.015	30.50	4.2	0.15	3.95	3.45	1.95	33	0.3	4
APB04.356.015	35.60	4.2	0.15	3.95	3.45	1.95	38	0.3	4
APB04.406.020	40.60	4.2	0.15	3.95	3.45	1.95	43	0.3	4
APB05.102.020	10.2	5.2	0.2	4.95	4.25	2.45	13	0.5	5
APB05.152.020	15.20	5.2	0.2	4.95	4.25	2.45	18	0.5	5
APB05.203.020	20.30	5.2	0.2	4.95	4.25	2.45	23	0.5	5
APB05.254.020	25.40	5.2	0.2	4.95	4.25	2.45	28	0.5	5
APB05.305.020	30.50	5.2	0.2	4.95	4.25	2.45	33	0.5	5
APB05.356.020	35.60	5.2	0.2	4.95	4.25	2.45	38	0.5	5
APB05.406.020	40.60	5.2	0.2	4.95	4.25	2.45	43	0.5	5
APB06.102.020	10.2	6.2	0.2	5.95	5.25	2.95	13	0.5	6
APB06.152.020	15.20	6.2	0.2	5.95	5.25	2.95	18	0.5	6
APB06.203.020	20.30	6.2	0.2	5.95	5.25	2.95	23	0.5	6
APB06.254.020	25.40	6.2	0.2	5.95	5.25	2.95	28	0.5	6
APB06.305.020	30.50	6.2	0.2	5.95	5.25	2.95	33	0.5	6
APB06.356.020	35.60	6.2	0.2	5.95	5.25	2.95	38	0.5	6
APB06.406.020	40.60	6.2	0.2	5.95	5.25	2.95	43	0.5	6
APB06.508.020	50.80	6.2	0.2	5.95	5.25	2.95	53	0.5	6
APB07.254.020	25.40	7.2	0.2	6.95	6.25	3.45	28	0.5	7
APB07.305.020	30.50	7.2	0.2	6.95	6.25	3.45	33	0.5	7
APB07.356.020	35.60	7.2	0.2	6.95	6.25	3.45	38	0.5	7
APB07.406.020	40.60	7.2	0.2	6.95	6.25	3.45	43	0.5	7
APB07.508.020	50.80	7.2	0.2	6.95	6.25	3.45	53	0.5	7
APB07.608.020	60.80	7.2	0.2	6.95	6.25	3.45	63	0.5	7

Sipariş Örneği/Ordering Example/Bestellbeispiel 1 ad./pcs./stück APB04.102.015.32



TERS TORNALAMA MINI CUT TAKIMLAR

MINI CUT BACK BORING /
MINI CUT ZURÜCK BOHRUNGE

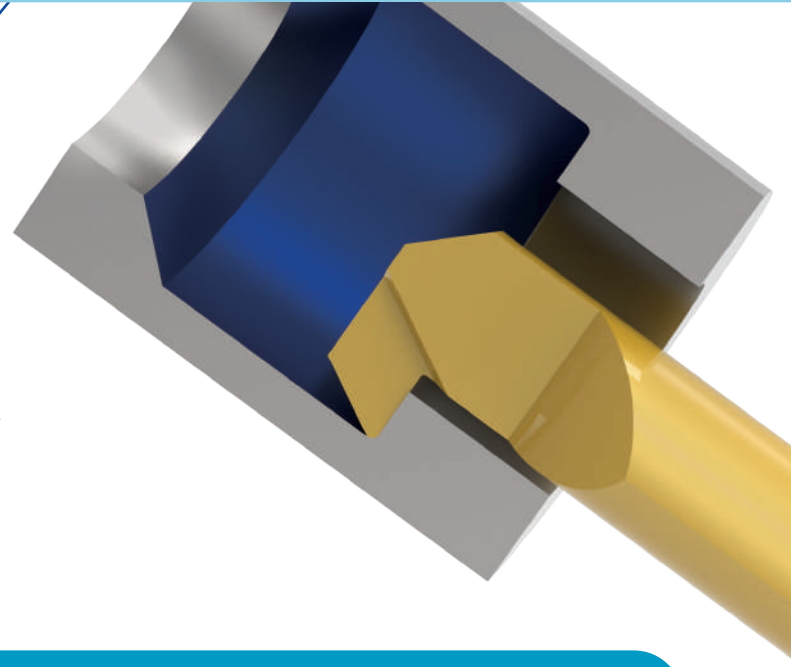
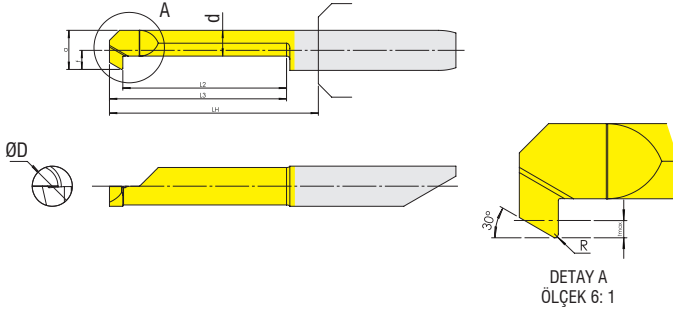

Ürün Kodu
Product Code
Artikelnummer

Takım Ölçüleri (mm)
Dimension (mm)
Abmessung (mm)

	L2	L3	Ødmin	R	a	d	f	LH	tmax	ØD
APBB04.152.010.32	13.2	15.20	3.2	0.1	2.95	2.3	1.45	18	0.5	4
APBB04.203.010.32	18.3	20.30	3.2	0.1	2.95	2.3	1.45	23	0.5	4
APBB04.152.015.42	13.2	15.20	4.2	0.15	3.95	2.5	1.95	18	0.8	4
APBB04.254.015.42	23.4	25.40	4.2	0.15	3.95	2.5	1.95	28	0.8	4
APBB05.203.020.52	18.3	20.30	5.2	0.2	4.95	3.8	2.45	23	1	5
APBB05.305.020.52	28.5	30.50	5.2	0.2	4.95	3.8	2.45	33	1	5
APBB06.203.020.62	18.3	20.30	6.2	0.2	5.95	3.8	2.95	23	1.8	6
APBB06.305.020.62	28.5	30.50	6.2	0.2	5.95	3.8	2.95	33	1.8	6
APBB07.203.020.72	17.3	20.30	7.2	0.2	6.95	4.25	3.45	23	2.5	7
APBB07.305.020.72	27.5	30.50	7.2	0.2	6.95	4.25	3.45	33	2.5	7

Sipariş Örneği/Ordering Example/Bestellbeispiel
1 ad./pcs./stück APBB04.152.010.32

KANAL AÇMA MINI CUT TAKIMLAR

MINI CUT GROOVING / MINI CUT NUTENSTECHEN

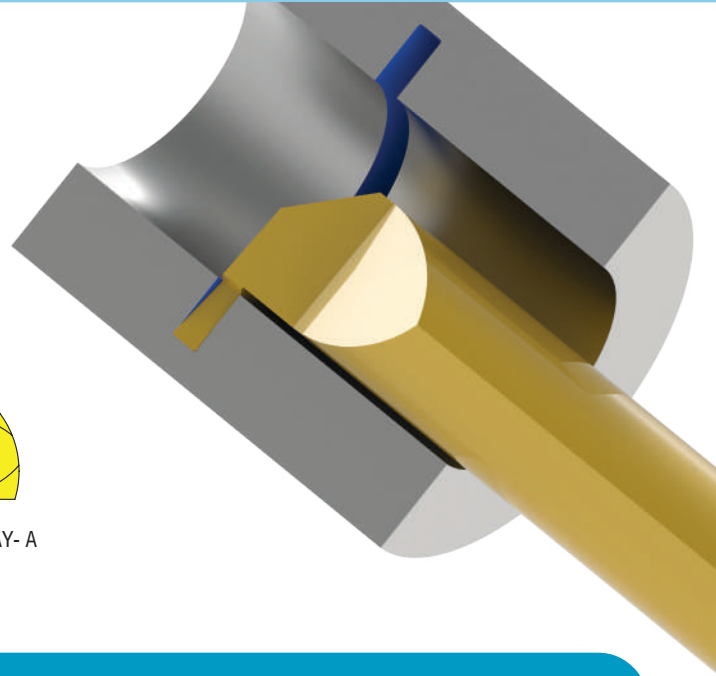
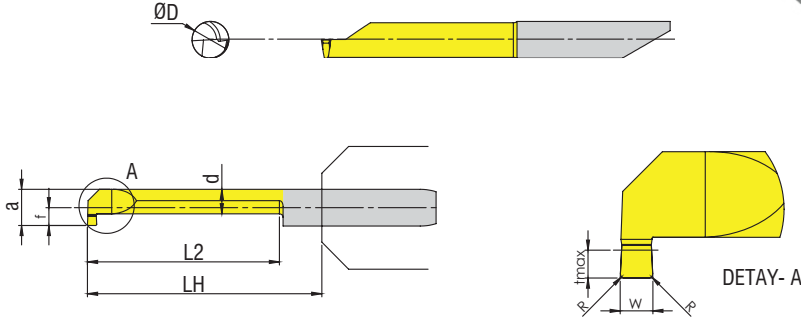

Ürün Kodu
Product Code
Artikelnummer

Takım Ölçüleri (mm)
Dimension (mm)
Abmessung (mm)

	W	L2	Ødmin	R	a	d	f	LH	tmax	ØD
APG04.080.102	0.8	10.2	4.2	0.15	3.95	2.95	1.95	13	0.8	4
APG04.080.152	0.8	15.2	4.2	0.15	3.95	2.95	1.95	18	0.8	4
APG04.080.203	0.8	20.3	4.2	0.15	3.95	2.95	1.95	23	0.8	4
APG04.080.254	0.8	25.4	4.2	0.15	3.95	2.95	1.95	28	0.8	4
APG04.100.102	1.0	10.2	4.2	0.2	3.95	2.95	1.95	13	0.8	4
APG04.100.152	1.0	15.2	4.2	0.2	3.95	2.95	1.95	18	0.8	4
APG04.100.203	1.0	20.3	4.2	0.2	3.95	2.95	1.95	23	0.8	4
APG05.079.102	0.79	10.2	5.2	0.2	4.95	3.75	2.45	13	1.0	5
APG05.079.152	0.79	15.2	5.2	0.2	4.95	3.75	2.45	18	1.0	5
APG05.079.203	0.79	20.3	5.2	0.2	4.95	3.75	2.45	23	1.0	5
APG05.079.254	0.79	25.4	5.2	0.2	4.95	3.75	2.45	28	1.0	5
APG05.079.305	0.79	30.5	5.2	0.2	4.95	3.75	2.45	33	1.0	5
APG05.079.356	0.79	35.6	5.2	0.2	4.95	3.75	2.45	38	1.0	5
APG05.100.102	1.0	10.2	5.2	0.2	4.95	3.75	2.45	13	1.0	5
APG05.100.152	1.0	15.2	5.2	0.2	4.95	3.75	2.45	18	1.0	5
APG05.100.203	1.0	20.3	5.2	0.2	4.95	3.75	2.45	23	1.0	5
APG05.100.254	1.0	25.4	5.2	0.2	4.95	3.75	2.45	28	1.0	5
APG05.100.305	1.0	30.5	5.2	0.2	4.95	3.75	2.45	33	1.0	5
APG05.100.356	1.0	35.6	5.2	0.2	4.95	3.75	2.45	38	1.0	5

Sipariş Örneği/Ordering Example/Bestellbeispiel
1 ad./pcs./stück APG04.080.102

KANAL AÇMA MİNİ CUT TAKIMLAR
MINI CUT GROOVING / MINI CUT NUTENSTECHE

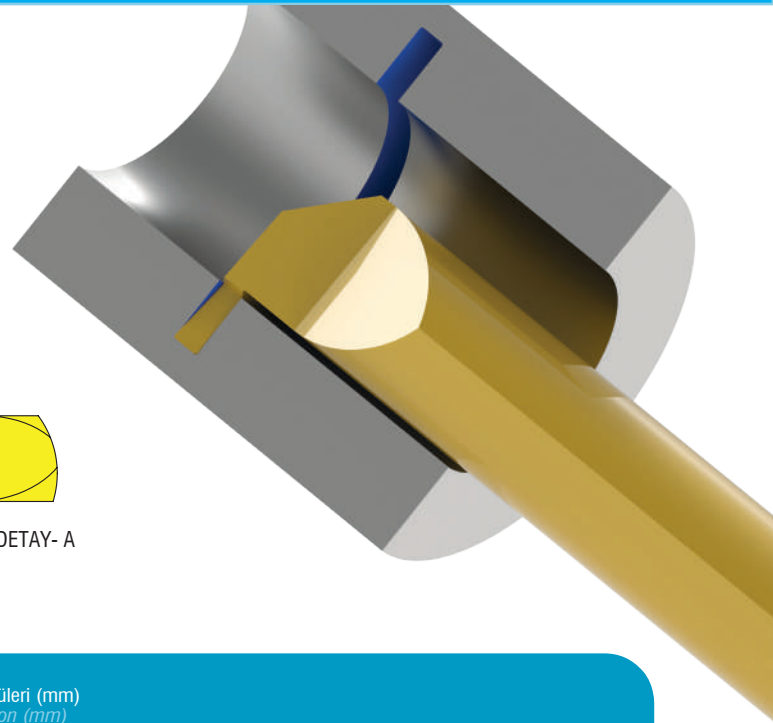
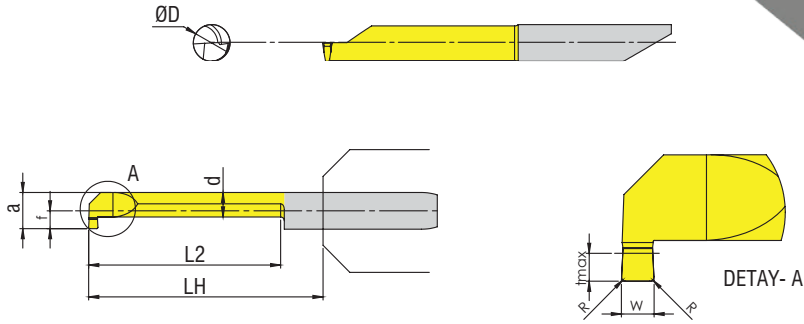

Ürün Kodu
Product Code
Artikelnummer

Takım Ölçüleri (mm)
Dimension (mm)
Abmessung (mm)

	W	L2	Ødmin	R	a	d	f	LH	tmax	ØD
APG05.117.102	1.17	10.2	5.2	0.2	4.95	3.75	2.45	13	1.0	5
APG05.117.152	1.17	15.2	5.2	0.2	4.95	3.75	2.45	18	1.0	5
APG05.117.203	1.17	20.3	5.2	0.2	4.95	3.75	2.45	23	1.0	5
APG05.117.254	1.17	25.4	5.2	0.2	4.95	3.75	2.45	28	1.0	5
APG05.117.305	1.17	30.5	5.2	0.2	4.95	3.75	2.45	33	1.0	5
APG05.117.356	1.17	35.6	5.2	0.2	4.95	3.75	2.45	38	1.0	5
APG05.150.102	1.5	10.2	5.2	0.2	4.95	3.75	2.45	13	1.0	5
APG05.150.152	1.5	15.2	5.2	0.2	4.95	3.75	2.45	18	1.0	5
APG05.150.203	1.5	20.3	5.2	0.2	4.95	3.75	2.45	23	1.0	5
APG05.150.254	1.5	25.4	5.2	0.2	4.95	3.75	2.45	28	1.0	5
APG05.150.305	1.5	30.5	5.2	0.2	4.95	3.75	2.45	33	1.0	5
APG05.150.356	1.5	35.6	5.2	0.2	4.95	3.75	2.45	38	1.0	5
APG05.157.102	1.57	10.2	5.2	0.2	4.95	3.75	2.45	13	1.0	5
APG05.157.152	1.57	15.2	5.2	0.2	4.95	3.75	2.45	18	1.0	5
APG05.157.203	1.57	20.3	5.2	0.2	4.95	3.75	2.45	23	1.0	5
APG05.157.254	1.57	25.4	5.2	0.2	4.95	3.75	2.45	28	1.0	5
APG05.157.305	1.57	30.5	5.2	0.2	4.95	3.75	2.45	33	1.0	5

Sipariş Örneği/Ordering Example/Bestellbeispiel
1 ad./pcs./stück APG05.117.102

KANAL AÇMA MİNİ CUT TAKIMLAR
MINI CUT GROOVING / MINI CUT NUTENSTECHEIN

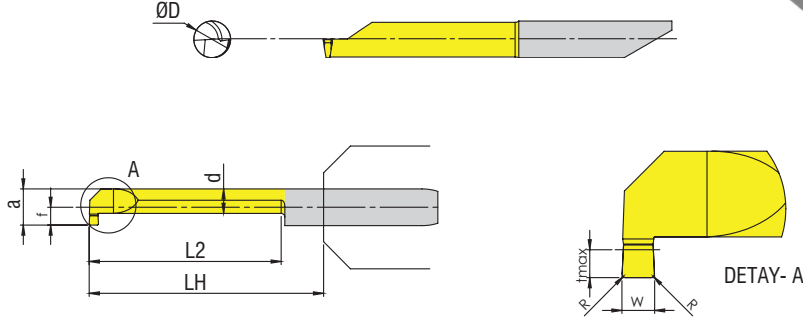

Ürün Kodu
Product Code
Artikelnummer

Takım Ölçüleri (mm)
Dimension (mm)
Abmessung (mm)

	W	L2	Ødmin	R	a	d	f	LH	tmax	ØD
APG05.198.102	1.98	10.2	5.2	0.2	4.95	3.75	2.45	13	1.0	5
APG05.198.152	1.98	15.2	5.2	0.2	4.95	3.75	2.45	18	1.0	5
APG05.198.203	1.98	20.3	5.2	0.2	4.95	3.75	2.45	23	1.0	5
APG05.198.254	1.98	25.4	5.2	0.2	4.95	3.75	2.45	28	1.0	5
APG05.198.305	1.98	30.5	5.2	0.2	4.95	3.75	2.45	33	1.0	5
APG05.200.102	2.0	10.2	5.2	0.2	4.95	3.75	2.45	13	1.0	5
APG05.200.152	2.0	15.2	5.2	0.2	4.95	3.75	2.45	18	1.0	5
APG05.200.203	2.0	20.3	5.2	0.2	4.95	3.75	2.45	23	1.0	5
APG05.200.254	2.0	25.4	5.2	0.2	4.95	3.75	2.45	28	1.0	5
APG05.200.305	2.0	30.5	5.2	0.2	4.95	3.75	2.45	33	1.0	5
APG06.079.102	0.79	10.2	6.2	0.2	5.95	3.95	2.95	13	1.8	6
APG06.079.152	0.79	15.2	6.2	0.2	5.95	3.95	2.95	18	1.8	6
APG06.079.203	0.79	20.3	6.2	0.2	5.95	3.95	2.95	23	1.8	6
APG06.079.254	0.79	25.4	6.2	0.2	5.95	3.95	2.95	28	1.8	6
APG06.079.305	0.79	30.5	6.2	0.2	5.95	3.95	2.95	33	1.8	6
APG06.079.356	0.79	35.6	6.2	0.2	5.95	3.95	2.95	38	1.8	6

Sipariş Örneği/Ordering Example/Bestellbeispiel
1 ad./pcs./stück APG05.198.102

KANAL AÇMA MINI CUT TAKIMLAR
MINI CUT GROOVING / MINI CUT NUTENSTECHEN

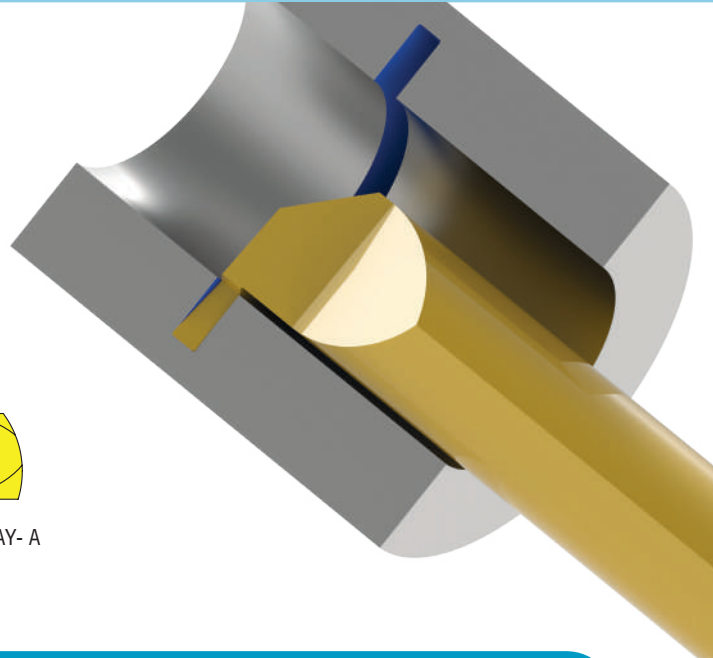
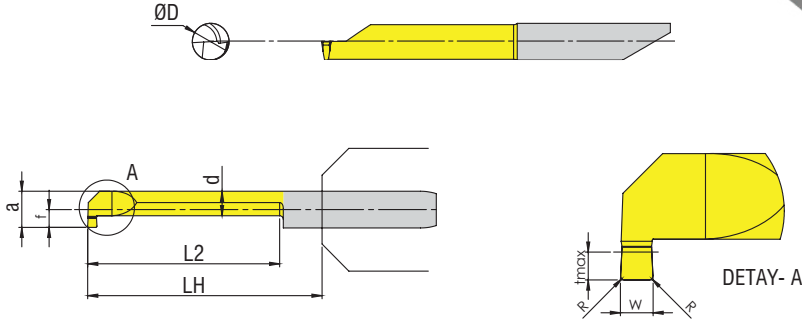

Ürün Kodu
Product Code
Artikelnummer

Takım Ölçüleri (mm)
Dimension (mm)
Abmessung (mm)

	W	L2	Ødmin	R	a	d	f	LH	tmax	ØD
APG06.100.102	1.0	10.2	6.2	0.2	5.95	3.95	2.95	13	1.8	6
APG06.100.152	1.0	15.2	6.2	0.2	5.95	3.95	2.95	18	1.8	6
APG06.100.203	1.0	20.3	6.2	0.2	5.95	3.95	2.95	23	1.8	6
APG06.100.254	1.0	25.4	6.2	0.2	5.95	3.95	2.95	28	1.8	6
APG06.100.305	1.0	30.5	6.2	0.2	5.95	3.95	2.95	33	1.8	6
APG06.100.356	1.0	35.6	6.2	0.2	5.95	3.95	2.95	38	1.8	6
APG06.100.406	1.0	40.6	6.2	0.2	5.95	3.95	2.95	43	1.8	6
APG06.117.102	1.17	10.2	6.2	0.2	5.95	3.95	2.95	13	1.8	6
APG06.117.152	1.17	15.2	6.2	0.2	5.95	3.95	2.95	18	1.8	6
APG06.117.203	1.17	20.3	6.2	0.2	5.95	3.95	2.95	23	1.8	6
APG06.117.254	1.17	25.4	6.2	0.2	5.95	3.95	2.95	28	1.8	6
APG06.117.305	1.17	30.5	6.2	0.2	5.95	3.95	2.95	33	1.8	6
APG06.117.356	1.17	35.6	6.2	0.2	5.95	3.95	2.95	38	1.8	6
APG06.117.406	1.17	40.6	6.2	0.2	5.95	3.95	2.95	43	1.8	6
APG06.150.102	1.5	10.2	6.2	0.2	5.95	3.95	2.95	13	1.8	6
APG06.150.152	1.5	15.2	6.2	0.2	5.95	3.95	2.95	18	1.8	6
APG06.150.203	1.5	20.3	6.2	0.2	5.95	3.95	2.95	23	1.8	6
APG06.150.254	1.5	25.4	6.2	0.2	5.95	3.95	2.95	28	1.8	6
APG06.150.305	1.5	30.5	6.2	0.2	5.95	3.95	2.95	33	1.8	6
APG06.150.356	1.5	35.6	6.2	0.2	5.95	3.95	2.95	38	1.8	6

Sipariş Örneği/Ordering Example/Bestellbeispiel
1 ad./pcs./stück APG06.100.102

KANAL AÇMA MINI CUT TAKIMLAR
MINI CUT GROOVING / MINI CUT NUTENSTECHEN

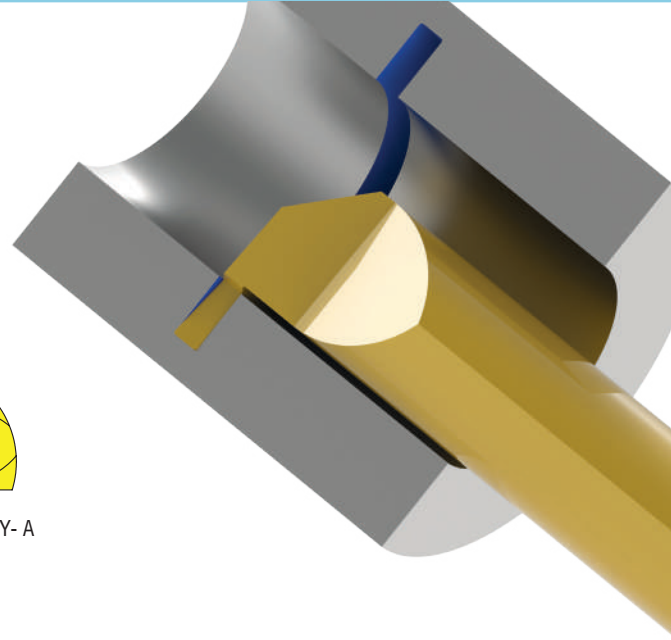
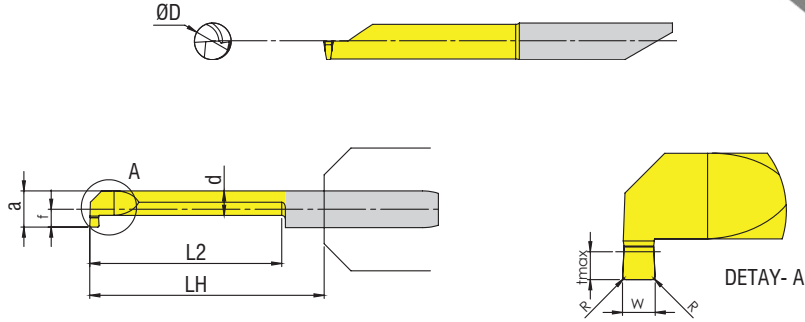

Ürün Kodu
Product Code
Artikelnummer

Takım Ölçüleri (mm)
Dimension (mm)
Abmessung (mm)

	W	L2	Ødmin	R	a	d	f	LH	tmax	ØD
APG06.157.102	1.57	10.2	6.2	0.2	5.95	3.95	2.95	13	1.8	6
APG06.157.152	1.57	15.2	6.2	0.2	5.95	3.95	2.95	18	1.8	6
APG06.157.203	1.57	20.3	6.2	0.2	5.95	3.95	2.95	23	1.8	6
APG06.157.254	1.57	25.4	6.2	0.2	5.95	3.95	2.95	28	1.8	6
APG06.157.305	1.57	30.5	6.2	0.2	5.95	3.95	2.95	33	1.8	6
APG06.157.356	1.57	35.6	6.2	0.2	5.95	3.95	2.95	38	1.8	6
APG06.157.406	1.57	40.6	6.2	0.2	5.95	3.95	2.95	43	1.8	6
APG06.198.102	1.98	10.2	6.2	0.2	5.95	3.95	2.95	13	1.8	6
APG06.198.152	1.98	15.2	6.2	0.2	5.95	3.95	2.95	18	1.8	6
APG06.198.203	1.98	20.3	6.2	0.2	5.95	3.95	2.95	23	1.8	6
APG06.198.254	1.98	25.4	6.2	0.2	5.95	3.95	2.95	28	1.8	6
APG06.198.305	1.98	30.5	6.2	0.2	5.95	3.95	2.95	33	1.8	6
APG06.198.356	1.98	35.6	6.2	0.2	5.95	3.95	2.95	38	1.8	6
APG06.198.406	1.98	40.6	6.2	0.2	5.95	3.95	2.95	43	1.8	6
APG06.200.102	2.0	10.2	6.2	0.2	5.95	3.95	2.95	13	1.8	6
APG06.200.152	2.0	15.2	6.2	0.2	5.95	3.95	2.95	18	1.8	6
APG06.200.203	2.0	20.3	6.2	0.2	5.95	3.95	2.95	23	1.8	6
APG06.200.254	2.0	25.4	6.2	0.2	5.95	3.95	2.95	28	1.8	6
APG06.200.305	2.0	30.5	6.2	0.2	5.95	3.95	2.95	33	1.8	6
APG06.200.356	2.0	35.6	6.2	0.2	5.95	3.95	2.95	38	1.8	6

Sipariş Örneği/Ordering Example/Bestellbeispiel
1 ad./pcs./stück APG06.157.102

KANAL AÇMA MİNİ CUT TAKIMLAR
MINI CUT GROOVING / MINI CUT NUTENSTECHEN

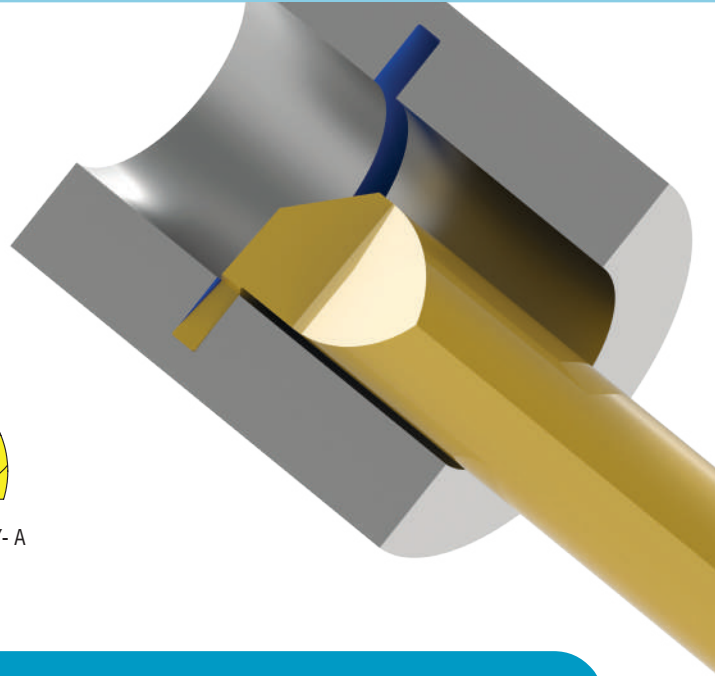
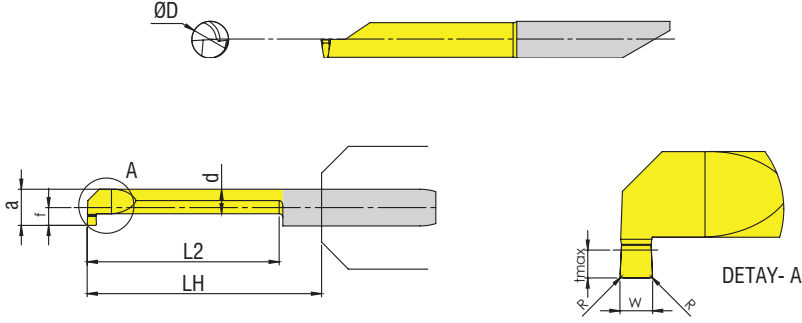

Ürün Kodu
Product Code
Artikelnummer

Takım Ölçüleri (mm)
Dimension (mm)
Abmessung (mm)

	W	L2	Ødmin	R	a	d	f	LH	tmax	ØD
APG07.079.102	0.79	10.2	7.2	0.2	6.95	4.25	3.45	13	2.5	7
APG07.079.152	0.79	15.2	7.2	0.2	6.95	4.25	3.45	18	2.5	7
APG07.079.203	0.79	20.3	7.2	0.2	6.95	4.25	3.45	23	2.5	7
APG07.079.254	0.79	25.4	7.2	0.2	6.95	4.25	3.45	28	2.5	7
APG07.079.305	0.79	30.5	7.2	0.2	6.95	4.25	3.45	33	2.5	7
APG07.079.356	0.79	35.6	7.2	0.2	6.95	4.25	3.45	38	2.5	7
APG07.079.406	0.79	40.6	7.2	0.2	6.95	4.25	3.45	43	2.5	7
APG07.100.102	1.0	10.2	7.2	0.2	6.95	4.25	3.45	13	2.5	7
APG07.100.152	1.0	15.2	7.2	0.2	6.95	4.25	3.45	18	2.5	7
APG07.100.203	1.0	20.3	7.2	0.2	6.95	4.25	3.45	23	2.5	7
APG07.100.254	1.0	25.4	7.2	0.2	6.95	4.25	3.45	28	2.5	7
APG07.100.305	1.0	30.5	7.2	0.2	6.95	4.25	3.45	33	2.5	7
APG07.100.356	1.0	35.6	7.2	0.2	6.95	4.25	3.45	38	2.5	7
APG07.100.406	1.0	40.6	7.2	0.2	6.95	4.25	3.45	43	2.5	7
APG07.117.102	1.17	10.2	7.2	0.2	6.95	4.25	3.45	13	2.5	7
APG07.117.152	1.17	15.2	7.2	0.2	6.95	4.25	3.45	18	2.5	7
APG07.117.203	1.17	20.3	7.2	0.2	6.95	4.25	3.45	23	2.5	7
APG07.117.254	1.17	25.4	7.2	0.2	6.95	4.25	3.45	28	2.5	7
APG07.117.305	1.17	30.5	7.2	0.2	6.95	4.25	3.45	33	2.5	7
APG07.117.356	1.17	35.6	7.2	0.2	6.95	4.25	3.45	38	2.5	7
APG07.117.406	1.17	40.6	7.2	0.2	6.95	4.25	3.45	43	2.5	7

Sipariş Örneği/Ordering Example/Bestellbeispiel
1 ad./pcs./stück APG07.079.102

KANAL AÇMA MİNİ CUT TAKIMLAR
MINI CUT GROOVING / MINI CUT NUTENSTECHEN

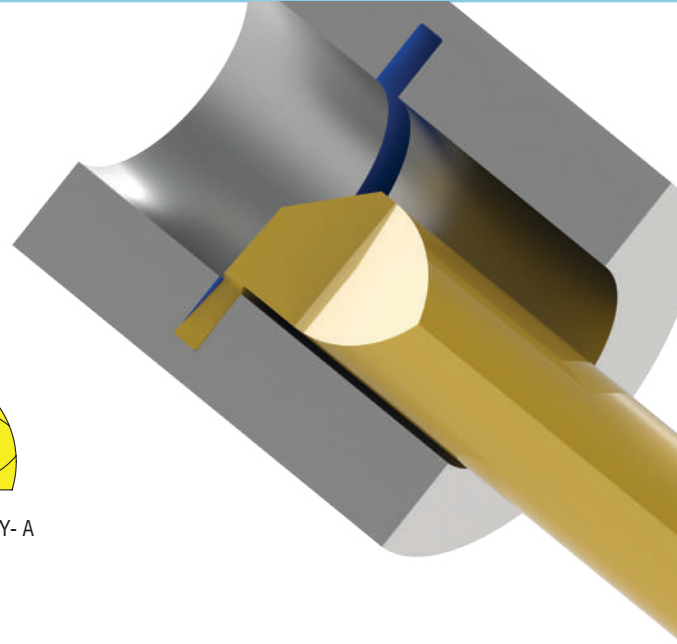
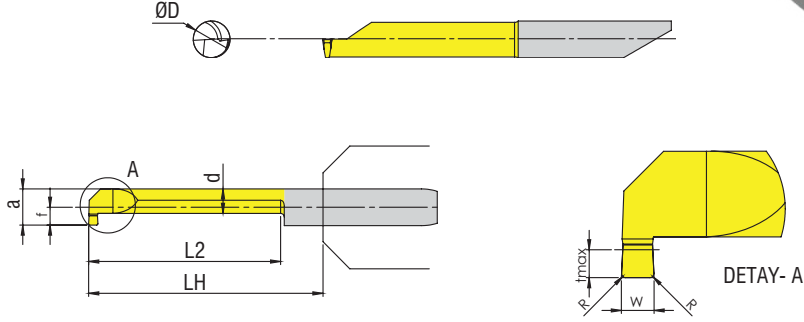

Ürün Kodu
Product Code
Artikelnummer

Takım Ölçüleri (mm)
Dimension (mm)
Abmessung (mm)

	W	L2	Ødmin	R	a	d	f	LH	tmax	ØD
APG07.150.102	1.5	10,2	7.2	0.2	6.95	4.25	3.45	13	2.5	7
APG07.150.152	1.5	15.2	7.2	0.2	6.95	4.25	3.45	18	2.5	7
APG07.150.203	1.5	20.3	7.2	0.2	6.95	4.25	3.45	23	2.5	7
APG07.150.254	1.5	25.4	7.2	0.2	6.95	4.25	3.45	28	2.5	7
APG07.150.305	1.5	30.5	7.2	0.2	6.95	4.25	3.45	33	2.5	7
APG07.150.356	1.5	35.6	7.2	0.2	6.95	4.25	3.45	38	2.5	7
APG07.150.406	1.5	40,6	7.2	0.2	6.95	4.25	3.45	43	2.5	7
APG07.157.102	1.57	10,2	7.2	0.2	6.95	4.25	3.45	13	2.5	7
APG07.157.152	1.57	15.2	7.2	0.2	6.95	4.25	3.45	18	2.5	7
APG07.157.203	1.57	20.3	7.2	0.2	6.95	4.25	3.45	23	2.5	7
APG07.157.254	1.57	25.4	7.2	0.2	6.95	4.25	3.45	28	2.5	7
APG07.157.305	1.57	30.5	7.2	0.2	6.95	4.25	3.45	33	2.5	7
APG07.157.356	1.57	35.6	7.2	0.2	6.95	4.25	3.45	38	2.5	7
APG07.157.406	1.57	40,6	7.2	0.2	6.95	4.25	3.45	43	2.5	7
APG07.198.102	1.98	10,2	7.2	0.2	6.95	4.25	3.45	13	2.5	7
APG07.198.152	1.98	15.2	7.2	0.2	6.95	4.25	3.45	18	2.5	7
APG07.198.203	1.98	20.3	7.2	0.2	6.95	4.25	3.45	23	2.5	7
APG07.198.254	1.98	25.4	7.2	0.2	6.95	4.25	3.45	28	2.5	7
APG07.198.305	1.98	30.5	7.2	0.2	6.95	4.25	3.45	33	2.5	7
APG07.198.356	1.98	35.6	7.2	0.2	6.95	4.25	3.45	38	2.5	7

Sipariş Örneği/Ordering Example/Bestellbeispiel
1 ad./pcs./stück APG07.150.102

KANAL AÇMA MINI CUT TAKIMLAR
MINI CUT GROOVING / MINI CUT NUTENSTECHEN

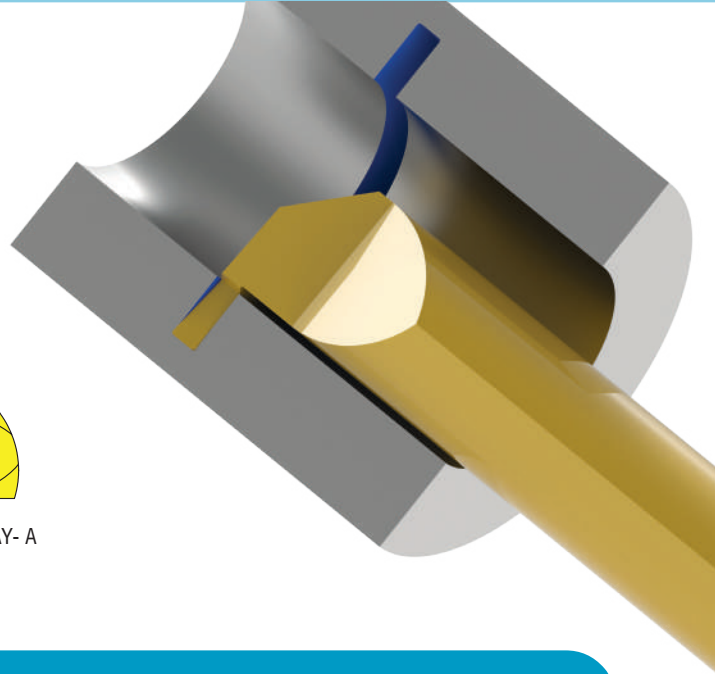
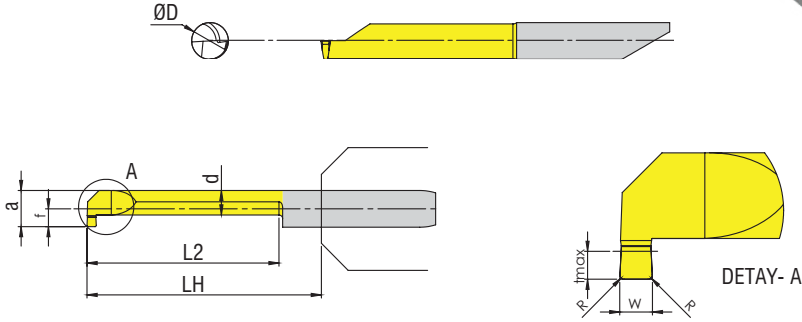

Ürün Kodu
Product Code
Artikelnummer

Takım Ölçüleri (mm)
Dimension (mm)
Abmessung (mm)

	W	L2	Ødmin	R	a	d	f	LH	tmax	ØD
APG07.200.102	2.0	10.2	7.2	0.2	6.95	4.25	3.45	13	2.5	7
APG07.200.152	2.0	15.2	7.2	0.2	6.95	4.25	3.45	18	2.5	7
APG07.200.203	2.0	20.3	7.2	0.2	6.95	4.25	3.45	23	2.5	7
APG07.200.254	2.0	25.4	7.2	0.2	6.95	4.25	3.45	28	2.5	7
APG07.200.305	2.0	30.5	7.2	0.2	6.95	4.25	3.45	33	2.5	7
APG07.200.356	2.0	35.6	7.2	0.2	6.95	4.25	3.45	38	2.5	7
APG10.100.305	1.0	30.5	10.5	0.2	9.95	5.45	4.95	33.0	4.0	10
APG10.100.508	1.0	50.8	10.5	0.2	9.95	5.45	4.95	53.0	4.0	10
APG10.200.305	2.0	30.5	10.5	0.2	9.95	5.45	4.95	33.0	4.0	10
APG10.200.508	2.0	50.8	10.5	0.2	9.95	5.45	4.95	53.0	4.0	10
APG10.300.305	3.0	30.5	10.5	0.2	9.95	5.45	4.95	33.0	4.0	10
APG10.300.508	3.0	50.8	10.5	0.2	9.95	5.45	4.95	53.0	4.0	10

Sipariş Örneği/Ordering Example/Bestellbeispiel
1 ad./pcs./stück APG07.200.102

KANAL AÇMA MİNİ CUT TAKIMLAR
MINI CUT GROOVING / MINI CUT NUTENSTECHEIN

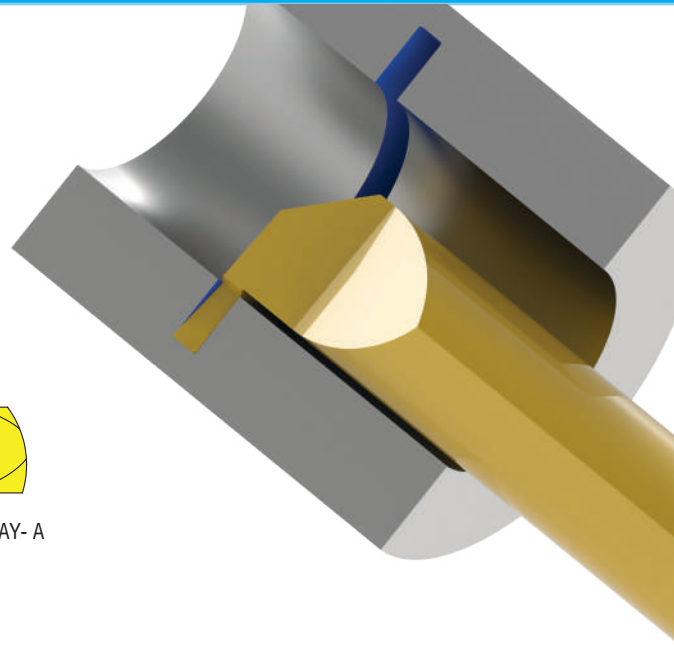
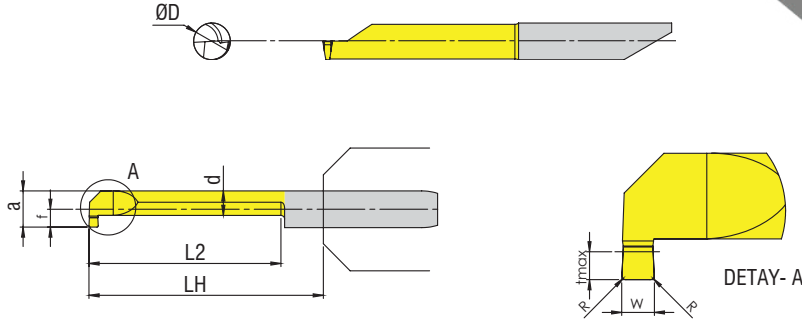

Ürün Kodu Product Code Artikelnummer	Takım Ölçüleri (mm) Dimension (mm) Abmessung (mm)									
	W	L2	Ødmin	R	a	d	f	LH	tmax	ØD
APG04.100.152.R050	1.0	15.2	4.2	0.5	3.95	2.95	1.95	18.0	0.8	4
APG04.117.152.R0585	1.17	15.2	4.2	0.585	3.95	2.95	1.95	18.0	0.8	4
APG05.100.203.R050	1.0	20.3	5.2	0.5	4.95	3.75	2.45	23.0	1.0	5
APG05.117.203.R0585	1.17	20.3	5.2	0.585	4.95	3.75	2.45	23.0	1.0	5
APG05.150.203.R075	1.5	20.3	5.2	0.75	4.95	3.75	2.45	23.0	1.0	5
APG05.1574.203.R0787	1.574	20.3	5.2	0.787	4.95	3.75	2.45	23.0	1.0	5
APG05.1626.203.R0813	1.626	20.3	5.2	0.813	4.95	3.75	2.45	23.0	1.0	5
APG05.198.203.R099	1.98	20.3	5.2	0.99	4.95	3.75	2.45	23.0	1.0	5
APG05.200.203.R100	2.0	20.3	5.2	1.0	4.95	3.75	2.45	23.0	1.0	5
APG06.100.254.R050	1.0	25.4	6.2	0.5	5.95	3.95	2.95	28.0	1.8	6
APG06.117.254.R0585	1.17	25.4	6.2	0.585	5.95	3.95	2.95	28.0	1.8	6
APG06.150.254.R075	1.5	25.4	6.2	0.75	5.95	3.95	2.95	28.0	1.8	6
APG06.1574.254.R0787	1.574	25.4	6.2	0.787	5.95	3.95	2.95	28.0	1.8	6
APG06.1626.254.R0813	1.626	25.4	6.2	0.813	5.95	3.95	2.95	28.0	1.8	6
APG06.198.254.R099	1.98	25.4	6.2	0.99	5.95	3.95	2.95	28.0	1.8	6
APG06.200.203.R100	2.0	20.3	6.2	1.0	5.95	3.95	2.95	23.0	1.8	6
APG06.200.254.R100	2.0	25.4	6.2	1.0	5.95	3.95	2.95	28.0	1.8	6
APG07.100.305.R050	1.0	30.5	7.2	0.5	6.95	4.25	3.45	33.0	2.5	7
APG07.117.305.R0585	1.17	30.5	7.2	0.585	6.95	4.25	3.45	33.0	2.5	7
APG07.150.305.R075	1.5	30.5	7.2	0.75	6.95	4.25	3.45	33.0	2.5	7
APG07.1574.305.R0787	1.574	30.5	7.2	0.787	6.95	4.25	3.45	33.0	2.5	7
APG07.1626.305.R0813	1.626	30.5	7.2	0.813	6.95	4.25	3.45	33.0	2.5	7
APG07.198.305.R099	1.98	30.5	7.2	0.99	6.95	4.25	3.45	33.0	2.5	7
APG07.200.305.R100	2.0	30.5	7.2	1.0	6.95	4.25	3.45	33.0	2.5	7

Sipariş Örneği/Ordering Example/Bestellbeispiel
1 ad./pcs./stück APG04.100.152.R050

DIŞ ÇEKME MINI CUT TAKIMLAR
MINI CUT THREADING / MINI CUT GEWINDEN

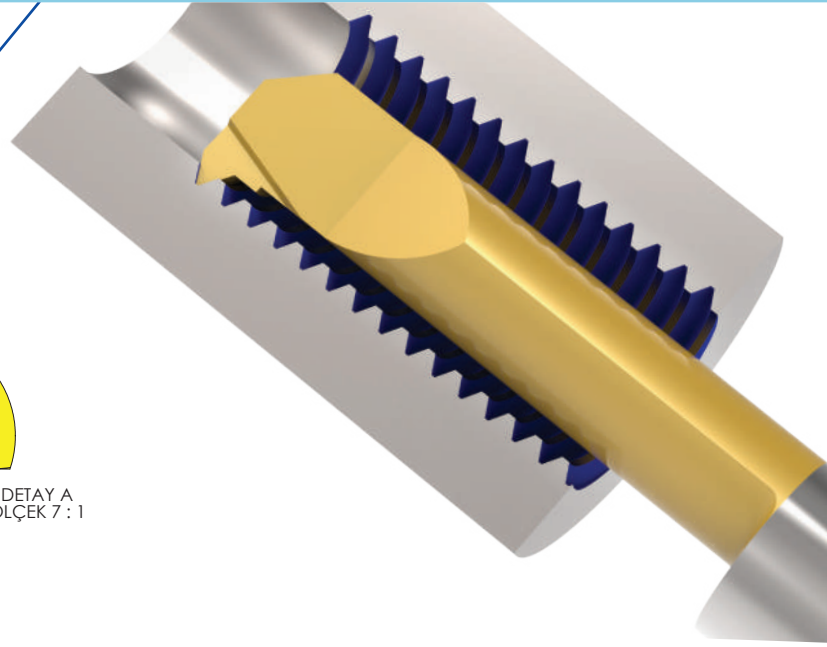
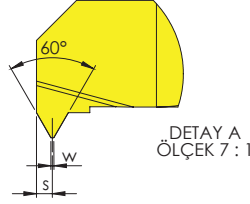
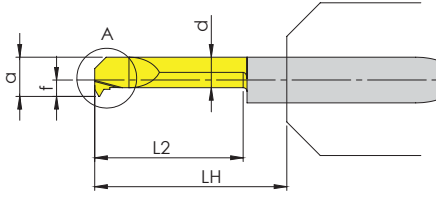
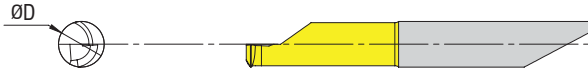

Ürün Kodu
Product Code
Artikelnummer

Takım Ölçüleri (mm)
Dimension (mm)
Abmessung (mm)

	PITCH		L2	ØDmin	a	d	f	LH	S	tmax	w	ØD
	min	max										
APT04.152.080	0.8	1.0	15.2	4.2	3.65	2.7	1.95	18.0	0.45	0.46	0.1	4
APT04.152.050	0.5	0.7	15.2	4.2	3.95	2.95	1.95	18.0	0.35	0.4	0.06	4
APT05.152.100	1.0	1.25	15.2	4.8	4.55	3.55	2.25	18.0	0.55	0.7	0.12	5
APT05.203.100	1.0	1.25	20.3	4.8	4.55	3.55	2.25	23.0	0.55	0.7	0.12	5
APT05.254.100	1.0	1.25	25.4	4.8	4.55	3.55	2.25	28.0	0.55	0.7	0.12	5
APT05.152.075	0.75	1.0	15.2	5.2	4.85	3.65	2.40	18.0	0.45	0.57	0.09	5
APT05.152.050	0.5	0.75	15.2	5.2	4.95	3.75	2.45	18.0	0.35	0.43	0.06	5
APT06.152.100	1.0	1.25	15.2	6.2	5.95	3.95	2.95	18.0	0.55	0.7	0.12	6
APT06.152.125	1.25	1.5	15.2	6.2	5.95	3.95	2.95	18.0	0.75	0.84	0.16	6
APT06.203.125	1.25	1.5	20.3	6.2	5.95	3.95	2.95	23.0	0.75	0.84	0.16	6
APT06.254.125	1.25	1.5	25.4	6.2	5.95	3.95	2.95	28.0	0.75	0.84	0.16	6
APT06.152.150	1.5	1.75	15.2	6.2	5.95	3.95	2.95	18.0	0.8	0.98	0.18	6
APT06.203.150	1.5	1.75	20.3	6.2	5.95	3.95	2.95	23.0	0.8	0.98	0.18	6
APT06.203.175	1.75	2.0	20.3	6.2	5.95	3.95	2.95	23.0	1.0	1.18	0.25	6

Sipariş Örneği/Ordering Example/Bestellbeispiel
1 ad./pcs./stück APT.04.152.080

ALIN KANAL AÇMA MİNİ CUT TAKIMLAR
MINI CUT FACE GROOVING / MINI CUT AXIALSTECHEIN

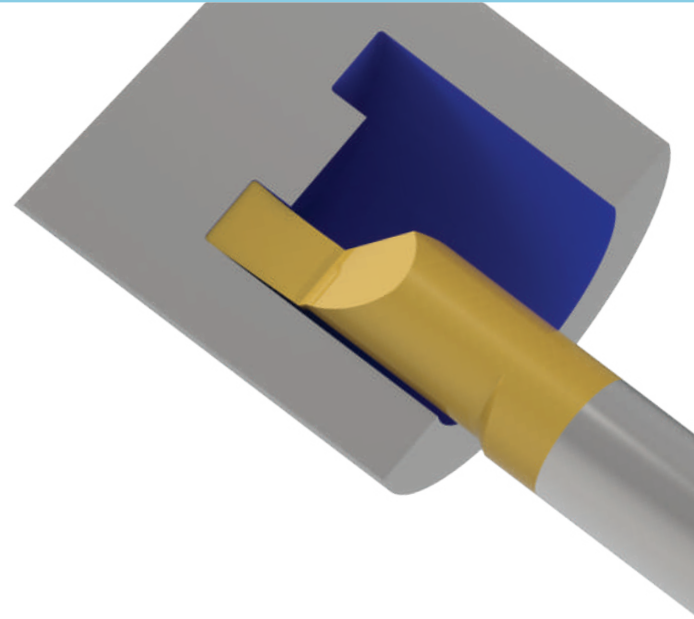
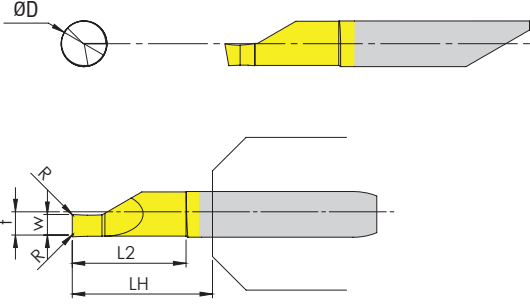

Ürün Kodu
Product Code
Artikelnummer

Takım Ölçüleri (mm)
Dimension (mm)
Abmessung (mm)

	W	L2	Ødmin	R	f	LH	tmax	ØD
APFG06.152.0787.R005	0.787	15.2	6.2	0.05	2.95	18.0	1.8	6
APFG06.152.1000.R005	1.0	15.2	6.2	0.05	2.95	18.0	2.0	6
APFG06.152.1500.R005	1.5	15.2	6.2	0.05	2.95	18.0	3.0	6
APFG06.152.1000.R015	1.0	15.2	6.2	0.15	2.95	18.0	2.0	6
APFG06.152.1168.R015	1.168	15.2	6.2	0.15	2.95	18.0	2.34	6
APFG06.152.1500.R015	1.5	15.2	6.2	0.15	2.95	18.0	3.0	6
APFG06.152.1575.R015	1.575	15.2	6.2	0.15	2.95	18.0	3.15	6
APFG06.152.1981.R015	1.981	15.2	6.2	0.15	2.95	18.0	3.95	6
APFG06.152.2000.R015	2.0	15.2	6.2	0.15	2.95	18.0	4.0	6
APFG06.152.2388.R015	2.388	15.2	6.2	0.15	2.95	18.0	5.0	6
APFG06.152.2500.R015	2.5	15.2	6.2	0.15	2.95	18.0	5.0	6
APFG06.152.3000.R015	3.0	15.2	6.2	0.15	2.95	18.0	6.0	6
APFG06.152.3175.R015	3.175	15.2	6.2	0.15	2.95	18.0	6.0	6

Sipariş Örneği/Ordering Example/Bestellbeispiel
1 ad./pcs./stück APFG06.152.0787.R005

SPECIAL MINI CUT TOOLS

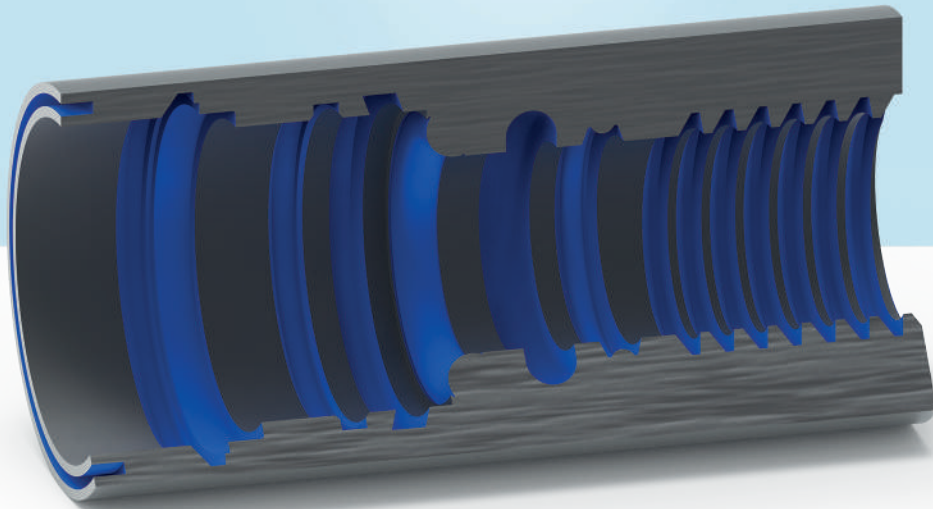

MINI CUT TAKIMLARI BİLGİ ALMA FORMU
 INFORMATION REQUEST FORM FOR MINI CUT TOOLS
 INFORMATIONSFORMULAR FÜR MINI CUT WERKZEUGE

TOOL TYPE	TOOL DIMENSIONS				
	ØD	ØDmin	L	RE	TMAX
BORING <input type="checkbox"/>					
GROOVING <input type="checkbox"/>				RE - R1,R2	W TMAX
FACE GROOVING <input type="checkbox"/>				RE - R1,R2	W TMAX
THREADING <input type="checkbox"/>				CHOOSE THREADING TYPE	
				METRIC <input type="checkbox"/>	NPT <input type="checkbox"/> UNF/UNC <input type="checkbox"/>
				TRAPEZOIDAL <input type="checkbox"/>	WHITWORTH <input type="checkbox"/> ACME <input type="checkbox"/>

TORX - ALYAN / PUNCH - KAZIMA TAKIMLARI

TORX-ALLEN / PUNCH - BROACH SET
TORX WINKELSCHRAUBENDEHER WERKZEUGE

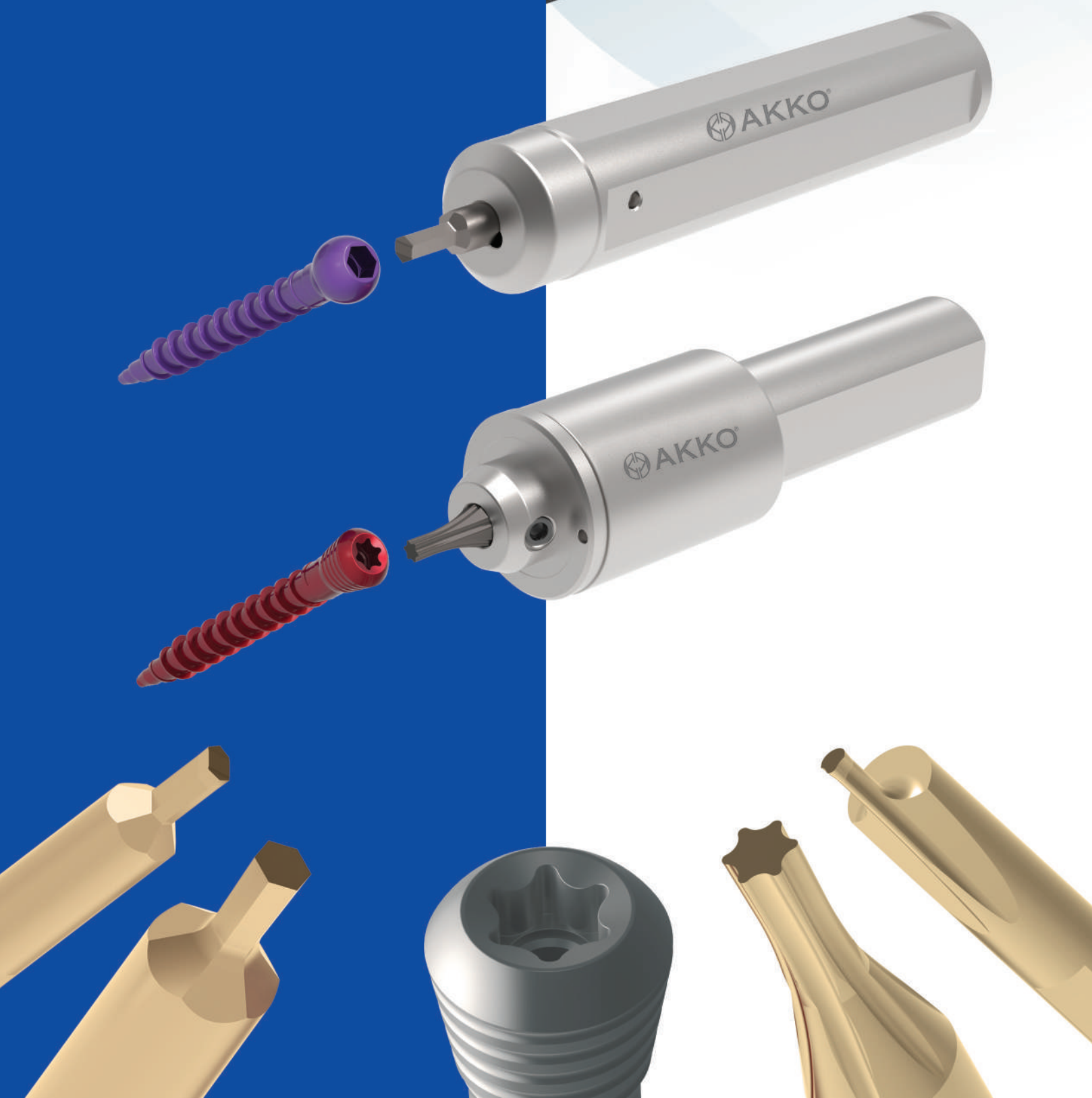

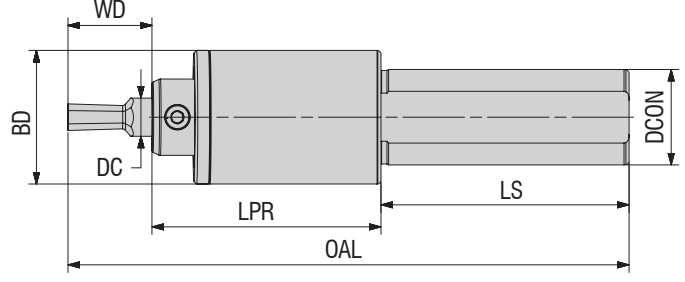

Ürün Kodu
 Product Code
 Artikelnummer

Uç Ölçüleri (mm)
 Insert Dimension (mm)
 Abmessung (mm)

	BD	DC	WD	LPR	LS	OAL	DCON
new ABTH-D08-W22-L125	Ø35.00	Ø8.00	15.00	60.00	65.00	125.00	Ø22.00
ABTH-D08-W25-L125	Ø35.00	Ø8.00	15.00	60.00	65.00	125.00	Ø25.00
new ABTH-D10-W20-L150	Ø35.00	Ø10.00	22.00	60.00	65.00	147.00	Ø20.00
new ABTH-D10-W22-L150	Ø35.00	Ø10.00	22.00	60.00	65.00	147.00	Ø22.00
new ABTH-D10-W25-L150	Ø35.00	Ø10.00	22.00	60.00	65.00	147.00	Ø25.00

Sipariş Örneği/Ordering Example/Bestellbeispiel
 1 ad./pcs./stück ABTH-D08-W22-L125

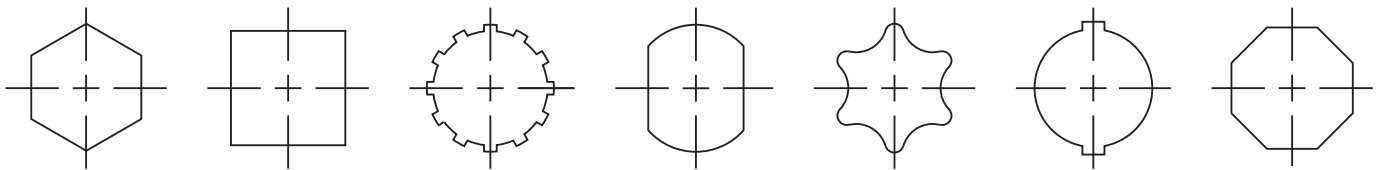
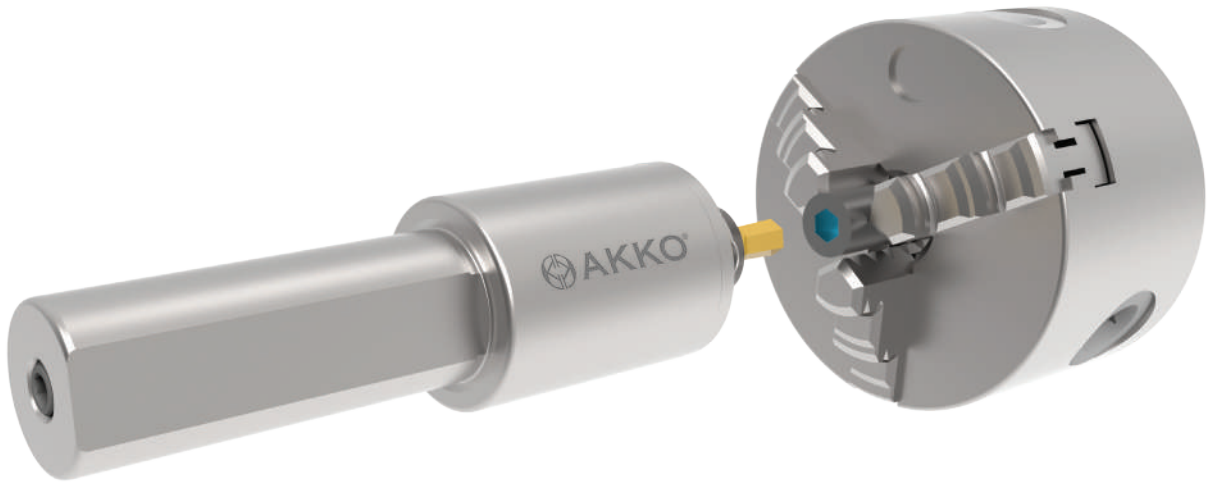

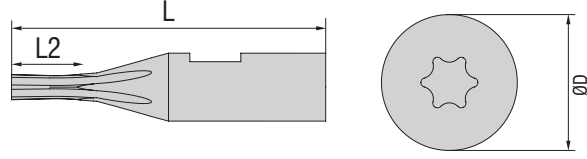

Ürün Kodu Product Code Artikelnummer	Soket Numarası Socket Number Seriennummer	Uç Ölçüleri (mm) Insert Dimension (mm) Abmessung (mm)		
		ØD	L2	L
APT-X-006	T6	8	3	30
APT-X-008	T8	8	3.8	30
APT-X-010	T10	8	4.6	30
APT-X-015	T15	8	5.4	30
APT-X-020	T20	8	6.2	30
APT-X-025	T25	10	6.5	45
APT-X-030	T30	10	7	45
APT-X-040	T40	10	8	45
APT-X-045	T45	10	9	45
APT-X-050	T50	10	10	45

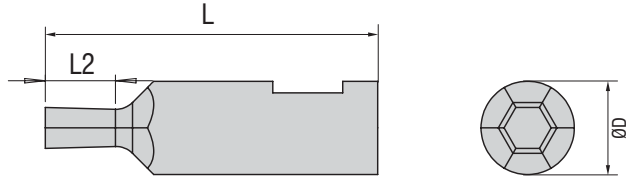

Ürün Kodu Product Code Artikelnummer	Soket Numarası Socket Number Seriennummer	Uç Ölçüleri (mm) Insert Dimension (mm) Abmessung (mm)		
		ØD	L2	L
APHX-0015	A1.5	8	3	30
APHX-0020	A2.0	8	4	30
APHX-0025	A2.5	8	5	30
APHX-0030	A3.0	8	6	30
APHX-0035	A3.5	8	7	30
APHX-0040	A4.0	8	8	30
APHX-0045	A4.5	8	9	30
APHX-0050	A5.0	8	10	30
APHX-0060	A6.0	8	11	30
APHX-0080	A8.0	10	12	45
APHX-0100	A10	12	12	45

Sipariş Örneği/Ordering Example/Bestellbeispiel
 1 ad./pcs./stück APTX-006

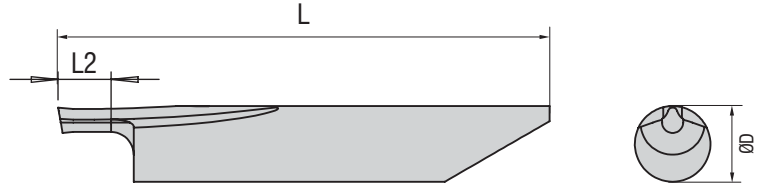

Ürün Kodu Product Code Artikelnummer	Soket Numarası Socket Number Seriennummer	Uç Ölçüleri (mm) Insert Dimension (mm) Abmessung (mm)		
		ØD	L2	L
AKTX-006	T6	6	3.0	38
AKTX-008	T8	6	4.0	38
AKTX-010	T10	6	4.5	38
AKTX-015	T15	6	4.5	38
AKTX-020	T20	6	5.0	38
AKTX-030	T30	6	6.0	38
AKTX-040	T40	6	6.5	38
AKTX-045	T45	6	7.0	38

Ürün Kodu Product Code Artikelnummer	Soket Numarası Socket Number Seriennummer	Uç Ölçüleri (mm) Insert Dimension (mm) Abmessung (mm)		
		ØD	L2	L
AKTX-050	T50	6	7.0	38
AKTX-055	T55	6	7.5	38
AKTX-060	T60	6	9.0	38
AKTX-070	T70	6	9.5	38
AKTX-080	T80	6	10.5	38
AKTX-090	T90	6	11.5	38
AKTX-0100	T100	6	12.0	38

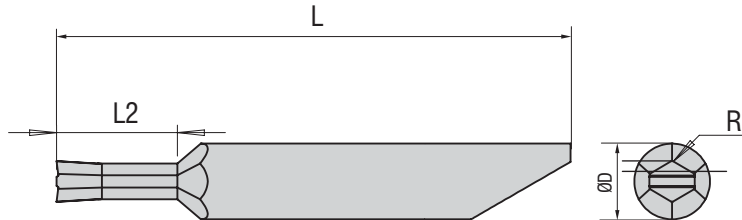
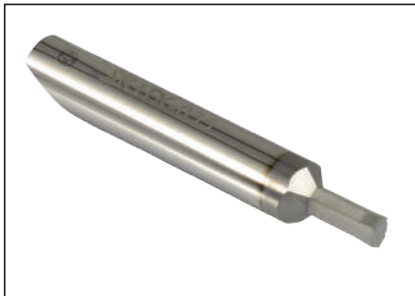

Ürün Kodu Product Code Artikelnummer	Soket Numarası Socket Number Seriennummer	Uç Ölçüleri (mm) Insert Dimension (mm) Abmessung (mm)			
		ØD	R	L2	L
AKHX-002-002	A2	6	0.05	3	38
AKHX-003-003	A3	6	0.05	6	38
AKHX-004-006	A4-6	6	0.10	8	38
AKHX-007-012	A7-12	8	0.15	12	38

Sipariş Örneği/Ordering Example/Bestellbeispiel
 1 ad./pcs./stück AKTX-006

S-DRILL

S-DRILL UÇLARI VE TAKIMLARI
S-DRILL INSERTS AND TOOLHOLDERS
WENDESCHNEIDPLATTEN UND WERKZEUGE
FÜR SPATENBOHRER HALTER

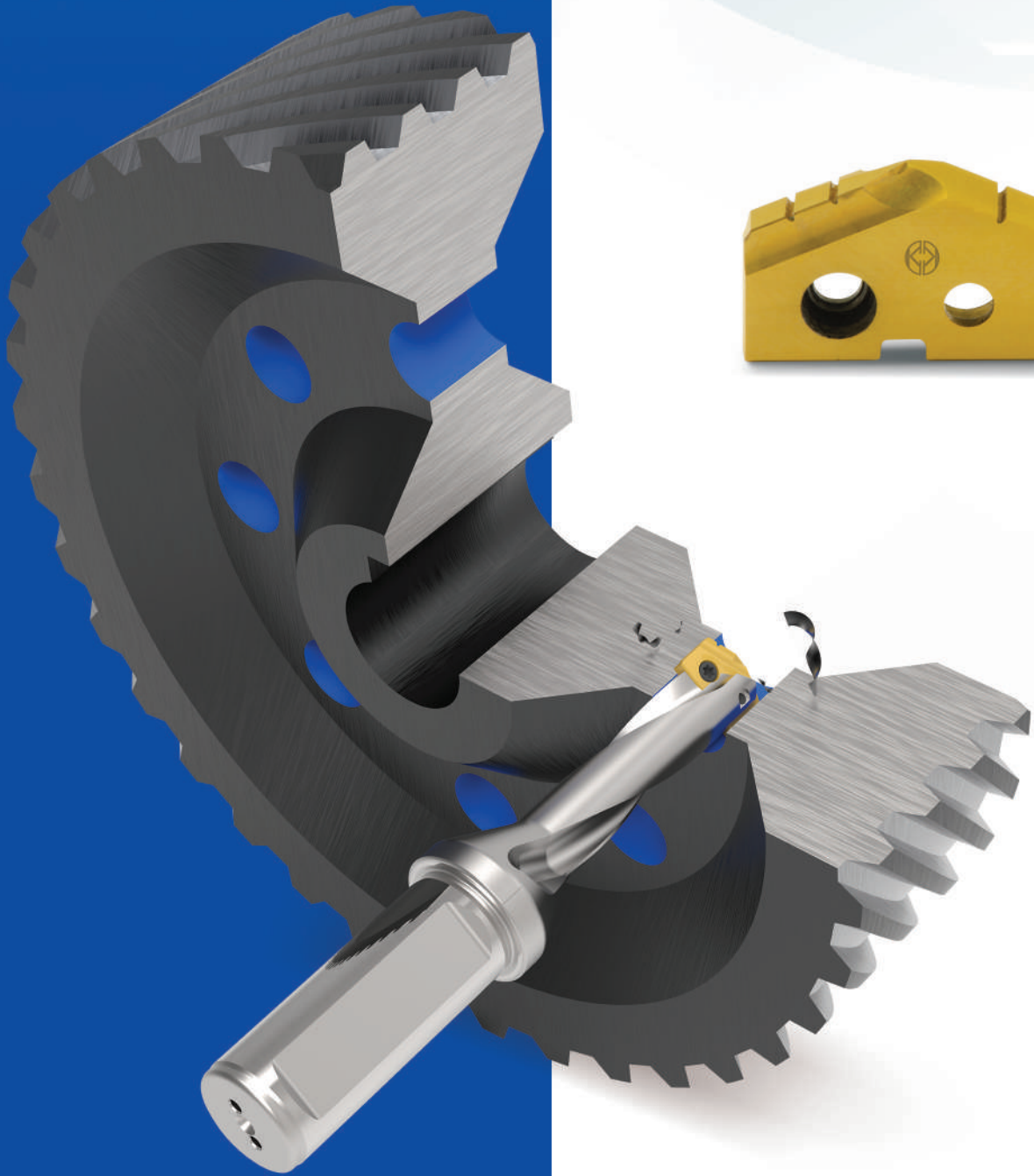

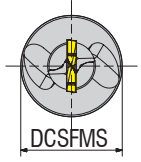
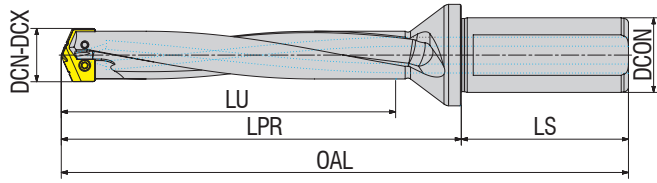

Takım Kodu Ordering Code Bestell-Bezeichnung	Stok Stock Lager	Takım Ölçüleri (mm) Dimension (mm) Abmessung (mm)								Kesici Uç Insert Wendeschneidplatte	Yedek Parçaları / Spare Parts / Ersatzteile	
		DCN	DCX	DCON	DCSFMS	OAL	LU	LPR	LS		Sıkma Vidası Screw Schraube	
ASD-0110-0119-D5-FW20	○	11	11.9	20	25	127	60	77	50	S1 SERIES	3006-M2x4	82-T06
ASD-0120-0129-D5-FW20	○	12	12.9	20	25	132	65	82	50	S1 SERIES		
ASD-0130-0139-D5-FW20	○	13	13.9	20	25	137	70	87	50	S2 SERIES	3008-M2.5x6	82-T08
ASD-0140-0149-D5-FW20	○	14	14.9	20	25	142	75	92	50	S2 SERIES		
ASD-0150-0164-D5-FW20	○	15	16.4	20	25	147	80	97	50	S2 SERIES		
ASD-0165-0179-D5-FW25	○	16.5	17.9	25	34	158	85	102	56	S2 SERIES	4008-M3x8	82-T08
ASD-0180-0209-D5-FW25	○	18	20.9	25	34	168	95	112	56	S3 SERIES		
ASD-0210-0244-D5-FW25	○	21	24.4	25	34	183	110	127	56	S3 SERIES	4515-M4x8	80-T15
ASD-0245-0299-D5-FW25	○	24.5	29.9	25	34	198	125	142	56	S4 SERIES		
ASD-0300-0349-D5-FW32	○	30	34.9	32	44	237	155	177	60	S4 SERIES		
ASD-0350-0394-D5-FW32	○	35	39.4	32	44	262	180	202	60	S5 SERIES	1020-M5x14	80-T15
ASD-0395-0439-D5-FW40	○	39.5	43.9	40	54	297	200	227	70	S5 SERIES		
ASD-0440-0480-D5-FW40	○	44	48	40	54	322	225	252	70	S5 SERIES		

● Stokta / In Stock / Auf Lager ○ Stokta Yok / Non Stock Item / Kein Lagerartikel, Lieferzeit auf Anfrage

Sipariş Örneği/Ordering Example/Bestellbeispiel
1 ad./pcs./stück ASD-0110-0119-D5-FW20



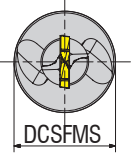
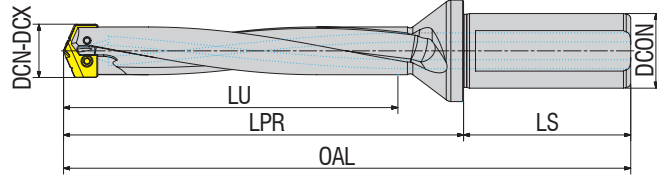

Takım Kodu Ordering Code Bestell-Bezeichnung	Stok Stock Lager	Takım Ölçüleri (mm) Dimension (mm) Abmessung (mm)								Kesici Uç Insert Wendeschneidplatte	Yedek Parçaları / Spare Parts / Ersatzteile	
		DCN	DCX	DCON	DCSFMS	OAL	LU	LPR	LS		Sıkma Vidası Screw Schraube	Tork Anahtar Torx Key Torx-Schlüssel
ASD-0110-0119-D7-FW20	○	11	11.9	20	25	149	82	99	50	S1 SERIES	3006-M2x4	82-T06
ASD-0120-0129-D7-FW20	○	12	12.9	20	25	156	89	106	50	S1 SERIES		
ASD-0130-0139-D7-FW20	○	13	13.9	20	25	163	96	113	50	S2 SERIES	3008-M2.5x6	82-T08
ASD-0140-0149-D7-FW20	○	14	14.9	20	25	170	103	120	50	S2 SERIES		
ASD-0150-0164-D7-FW20	○	15	16.4	20	25	177	110	127	50	S2 SERIES		
ASD-0165-0179-D7-FW25	○	16.5	17.9	25	34	190	117	134	56	S2 SERIES	4008-M3x8	82-T08
ASD-0180-0209-D7-FW25	○	18	20.9	25	34	204	131	148	56	S3 SERIES		
ASD-0210-0244-D7-FW25	○	21	24.4	25	34	225	152	169	56	S3 SERIES	4515-M4x8	80-T15
ASD-0245-0299-D7-FW25	○	24.5	29.9	25	34	246	173	190	56	S4 SERIES		
ASD-0300-0349-D7-FW32	○	30	34.9	32	44	297	215	237	60	S4 SERIES	1020-M5x14	80-T15
ASD-0350-0394-D7-FW32	○	35	39.4	32	44	332	250	272	60	S5 SERIES		
ASD-0395-0439-D7-FW40	○	39.5	43.9	40	54	375	278	305	70	S5 SERIES		
ASD-0440-0480-D7-FW40	○	44	48	40	54	410	313	340	70	S5 SERIES		

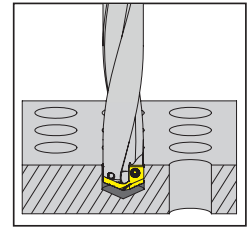
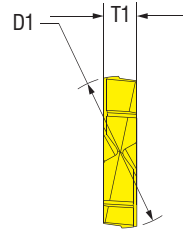
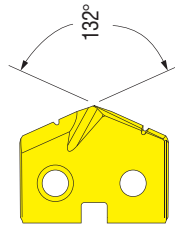

Uç Kodu Insert Code Wendepplatten-Bezeichnung	Stok Stock Lager	Uç Ölçüleri (mm) Insert Dimension (mm) Abmessung (mm)		Kaplamasız Uncoated ohne Beschichtung	Kaplama Coating Beschichtung		Uyumlu Takım Compatible Toolholder Kompatibles Werkzeug
		D1	T1	Uncoated	Sigma	Epsilon	
ASI.M.1100.SG	○	11.00	2.38	AK20X00	AK20X01	AK20X02	ASD-0110-0119-D7-FW20
ASI.M.1150.SG	○	11.50	2.38	AK20X00	AK20X01	AK20X02	ASD-0110-0119-D7-FW20
ASI.M.1200.SG	○	12.00	2.38	AK20X00	AK20X01	AK20X02	ASD-0120-0129-D7-FW20
ASI.M.1250.SG	○	12.50	2.38	AK20X00	AK20X01	AK20X02	ASD-0120-0129-D7-FW20
ASI.M.1290.SG	○	12.90	2.38	AK20X00	AK20X01	AK20X02	ASD-0120-0129-D7-FW20

● Stokta / In Stock / Auf Lager ○ Stokta Yok / Non Stock Item / Kein Lagerartikel, Lieferzeit auf Anfrage

Sipariş Örneği/Ordering Example/Bestellbeispiel
1 ad./pcs./stück ASD-0110-0119-D7-FW20



K for cast iron / döküm kalite

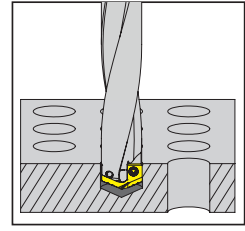
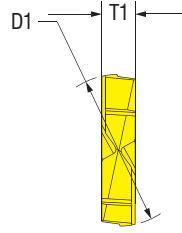
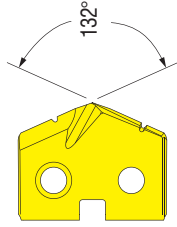

Uç Kodu Insert Code Wendepplatten-Bezeichnung	Stok Stock Lager	Uç Ölçüleri (mm) Insert Dimension (mm) Abmessung (mm)		Kaplamasız Uncoated ohne Beschichtung	Kaplama Coating Beschichtung		Uyumlu Takım Compatible Toolholder Kompatibles Werkzeug
		D1	T1	Uncoated	Sigma	Epsilon	
ASI.M.1300.SG	○	13.00	3.18	AK20X00	AK20X01	AK20X02	ASD-0130-0139-D7-FW20
ASI.M.1350.SG	○	13.50	3.18	AK20X00	AK20X01	AK20X02	ASD-0130-0139-D7-FW20
ASI.M.1400.SG	○	14.00	3.18	AK20X00	AK20X01	AK20X02	ASD-0140-0149-D7-FW20
ASI.M.1450.SG	○	14.50	3.18	AK20X00	AK20X01	AK20X02	ASD-0140-0149-D7-FW20
ASI.M.1500.SG	○	15.00	3.18	AK20X00	AK20X01	AK20X02	ASD-0150-0164-D7-FW20
ASI.M.1550.SG	○	15.50	3.18	AK20X00	AK20X01	AK20X02	ASD-0150-0164-D7-FW20
ASI.M.1600.SG	○	16.00	3.18	AK20X00	AK20X01	AK20X02	ASD-0150-0164-D7-FW20
ASI.M.1650.SG	○	16.50	3.18	AK20X00	AK20X01	AK20X02	ASD-0165-0179-D7-FW25
ASI.M.1700.SG	○	17.00	3.18	AK20X00	AK20X01	AK20X02	ASD-0165-0179-D7-FW25
ASI.M.1750.SG	○	17.50	3.18	AK20X00	AK20X01	AK20X02	ASD-0165-0179-D7-FW25
ASI.M.1790.SG	○	17.90	3.18	AK20X00	AK20X01	AK20X02	ASD-0165-0179-D7-FW25



K for cast iron / döküm kalite

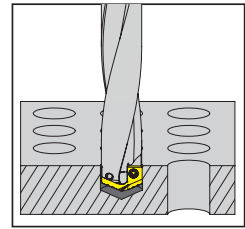
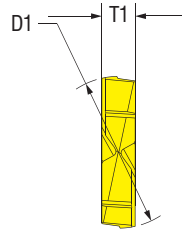
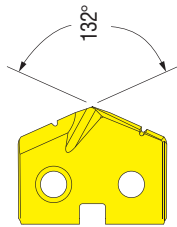

Uç Kodu Insert Code Wendepplatten-Bezeichnung	Stok Stock Lager	Uç Ölçüleri (mm) Insert Dimension (mm) Abmessung (mm)		Kaplamasız Uncoated ohne Beschichtung	Kaplama Coating Beschichtung		Uyumlu Takım Compatible Toolholder Kompatibles Werkzeug
		D1	T1	Uncoated	Sigma	Epsilon	
ASI.M.1800.SG	○	18.00	3.97	AK20X00	AK20X01	AK20X02	ASD-0180-0209-D7-FW25
ASI.M.1850.SG	○	18.50	3.97	AK20X00	AK20X01	AK20X02	ASD-0180-0209-D7-FW25
ASI.M.1900.SG	○	19.00	3.97	AK20X00	AK20X01	AK20X02	ASD-0180-0209-D7-FW25
ASI.M.1950.SG	○	19.50	3.97	AK20X00	AK20X01	AK20X02	ASD-0180-0209-D7-FW25
ASI.M.2000.SG	○	20.00	3.97	AK20X00	AK20X01	AK20X02	ASD-0180-0209-D7-FW25
ASI.M.2050.SG	○	20.50	3.97	AK20X00	AK20X01	AK20X02	ASD-0180-0209-D7-FW25
ASI.M.2100.SG	○	21.00	3.97	AK20X00	AK20X01	AK20X02	ASD-0210-0244-D7-FW25
ASI.M.2150.SG	○	21.50	3.97	AK20X00	AK20X01	AK20X02	ASD-0210-0244-D7-FW25
ASI.M.2200.SG	○	22.00	3.97	AK20X00	AK20X01	AK20X02	ASD-0210-0244-D7-FW25
ASI.M.2250.SG	○	22.50	3.97	AK20X00	AK20X01	AK20X02	ASD-0210-0244-D7-FW25
ASI.M.2300.SG	○	23.00	3.97	AK20X00	AK20X01	AK20X02	ASD-0210-0244-D7-FW25
ASI.M.2350.SG	○	23.50	3.97	AK20X00	AK20X01	AK20X02	ASD-0210-0244-D7-FW25
ASI.M.2400.SG	○	24.00	3.97	AK20X00	AK20X01	AK20X02	ASD-0210-0244-D7-FW25
ASI.M.2440.SG	○	24.40	3.97	AK20X00	AK20X01	AK20X02	ASD-0210-0244-D7-FW25

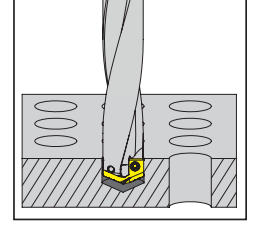
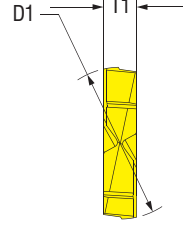
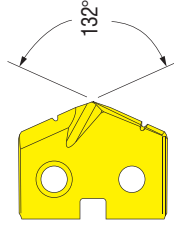

Uç Kodu Insert Code Wendepplatten-Bezeichnung	Stok Stock Lager	Uç Ölçüleri (mm) Insert Dimension (mm) Abmessung (mm)		Kaplamasız Uncoated ohne Beschichtung	Kaplama Coating Beschichtung		Uyumlu Takım Compatible Toolholder Kompatibles Werkzeug
		D1	T1	Uncoated	Sigma	Epsilon	
ASI.M.2450.SG	○	24.50	4.76	AK20X00	AK20X01	AK20X02	ASD-0245-0299-D7-FW25
ASI.M.2500.SG	○	25.00	4.76	AK20X00	AK20X01	AK20X02	ASD-0245-0299-D7-FW25
ASI.M.2550.SG	○	25.50	4.76	AK20X00	AK20X01	AK20X02	ASD-0245-0299-D7-FW25
ASI.M.2600.SG	○	26.00	4.76	AK20X00	AK20X01	AK20X02	ASD-0245-0299-D7-FW25
ASI.M.2650.SG	○	26.50	4.76	AK20X00	AK20X01	AK20X02	ASD-0245-0299-D7-FW25
ASI.M.2700.SG	○	27.00	4.76	AK20X00	AK20X01	AK20X02	ASD-0245-0299-D7-FW25
ASI.M.2750.SG	○	27.50	4.76	AK20X00	AK20X01	AK20X02	ASD-0245-0299-D7-FW25
ASI.M.2800.SG	○	28.00	4.76	AK20X00	AK20X01	AK20X02	ASD-0245-0299-D7-FW25
ASI.M.2850.SG	○	28.50	4.76	AK20X00	AK20X01	AK20X02	ASD-0245-0299-D7-FW25
ASI.M.2900.SG	○	29.00	4.76	AK20X00	AK20X01	AK20X02	ASD-0245-0299-D7-FW25
ASI.M.2950.SG	○	29.50	4.76	AK20X00	AK20X01	AK20X02	ASD-0245-0299-D7-FW25
ASI.M.3000.SG	○	30.00	4.76	AK20X00	AK20X01	AK20X02	ASD-0300-0349-D7-FW32
ASI.M.3050.SG	○	30.50	4.76	AK20X00	AK20X01	AK20X02	ASD-0300-0349-D7-FW32
ASI.M.3100.SG	○	31.00	4.76	AK20X00	AK20X01	AK20X02	ASD-0300-0349-D7-FW32
ASI.M.3150.SG	○	31.50	4.76	AK20X00	AK20X01	AK20X02	ASD-0300-0349-D7-FW32
ASI.M.3200.SG	○	32.00	4.76	AK20X00	AK20X01	AK20X02	ASD-0300-0349-D7-FW32
ASI.M.3250.SG	○	32.50	4.76	AK20X00	AK20X01	AK20X02	ASD-0300-0349-D7-FW32
ASI.M.3300.SG	○	33.00	4.76	AK20X00	AK20X01	AK20X02	ASD-0300-0349-D7-FW32
ASI.M.3350.SG	○	33.50	4.76	AK20X00	AK20X01	AK20X02	ASD-0300-0349-D7-FW32
ASI.M.3400.SG	○	34.00	4.76	AK20X00	AK20X01	AK20X02	ASD-0300-0349-D7-FW32
ASI.M.3450.SG	○	34.50	4.76	AK20X00	AK20X01	AK20X02	ASD-0300-0349-D7-FW32
ASI.M.3490.SG	○	34.90	4.76	AK20X00	AK20X01	AK20X02	ASD-0300-0349-D7-FW32

● Stokta / In Stock / Auf Lager ○ Stokta Yok / Non Stock Item / Kein Lagerartikel, Lieferzeit auf Anfrage

Sipariş Örneği/Ordering Example/Bestellbeispiel
1 ad./pcs./stück ASI.M.2450.SG



K for cast iron / döküm kalite

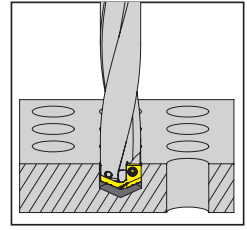
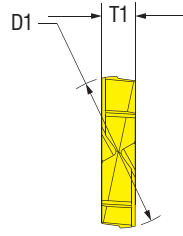
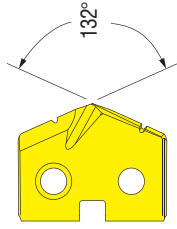

Uç Kodu Insert Code Wendepplatten-Bezeichnung	Stok Stock Lager	Uç Ölçüleri (mm) Insert Dimension (mm) Abmessung (mm)		Kaplamasız Uncoated ohne Beschichtung	Kaplama Coating Beschichtung		Uyumlu Takım Compatible Toolholder Kompatibles Werkzeug
		D1	T1	Uncoated	Sigma	Epsilon	
ASI.M.3500.SG	○	35.00	6.35	AK20X00	AK20X01	AK20X02	ASD-0350-0394-D5-FW32
ASI.M.3550.SG	○	35.50	6.35	AK20X00	AK20X01	AK20X02	ASD-0350-0394-D5-FW32
ASI.M.3600.SG	○	36.00	6.35	AK20X00	AK20X01	AK20X02	ASD-0350-0394-D5-FW32
ASI.M.3650.SG	○	36.50	6.35	AK20X00	AK20X01	AK20X02	ASD-0350-0394-D5-FW32
ASI.M.3700.SG	○	37.00	6.35	AK20X00	AK20X01	AK20X02	ASD-0350-0394-D5-FW32
ASI.M.3750.SG	○	37.50	6.35	AK20X00	AK20X01	AK20X02	ASD-0350-0394-D5-FW32
ASI.M.3800.SG	○	38.00	6.35	AK20X00	AK20X01	AK20X02	ASD-0350-0394-D5-FW32
ASI.M.3850.SG	○	38.50	6.35	AK20X00	AK20X01	AK20X02	ASD-0350-0394-D5-FW32
ASI.M.3900.SG	○	39.00	6.35	AK20X00	AK20X01	AK20X02	ASD-0350-0394-D5-FW32
ASI.M.3950.SG	○	39.50	6.35	AK20X00	AK20X01	AK20X02	ASD-0395-0439-D5-FW40
ASI.M.4000.SG	○	40.00	6.35	AK20X00	AK20X01	AK20X02	ASD-0395-0439-D5-FW40
ASI.M.4050.SG	○	40.50	6.35	AK20X00	AK20X01	AK20X02	ASD-0395-0439-D5-FW40
ASI.M.4100.SG	○	41.00	6.35	AK20X00	AK20X01	AK20X02	ASD-0395-0439-D5-FW40



K for cast iron / döküm kalite

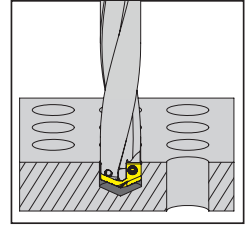
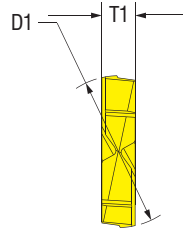
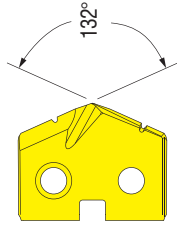



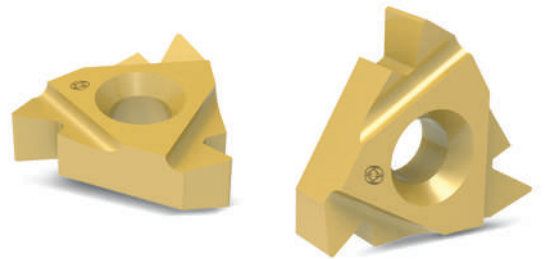

Uç Kodu Insert Code Wendepplatten-Bezeichnung	Stok Stock Lager	Uç Ölçüleri (mm) Insert Dimension (mm) Abmessung (mm)		Kaplamasız Uncoated ohne Beschichtung	Kaplama Coating Beschichtung		Uyumlu Takım Compatible Toolholder Kompatibles Werkzeug
		D1	T1	Uncoated	Sigma	Epsilon	
ASI.M.4150.SG	○	41.50	6.35	AK20X00	AK20X01	AK20X02	ASD-0395-0439-D5-FW40
ASI.M.4200.SG	○	42.00	6.35	AK20X00	AK20X01	AK20X02	ASD-0395-0439-D5-FW40
ASI.M.4250.SG	○	42.50	6.35	AK20X00	AK20X01	AK20X02	ASD-0395-0439-D5-FW40
ASI.M.4300.SG	○	43.00	6.35	AK20X00	AK20X01	AK20X02	ASD-0395-0439-D5-FW40
ASI.M.4350.SG	○	43.50	6.35	AK20X00	AK20X01	AK20X02	ASD-0395-0439-D5-FW40
ASI.M.4400.SG	○	44.00	6.35	AK20X00	AK20X01	AK20X02	ASD-0440-0480-D5-FW40
ASI.M.4450.SG	○	44.50	6.35	AK20X00	AK20X01	AK20X02	ASD-0440-0480-D5-FW40
ASI.M.4500.SG	○	45.00	6.35	AK20X00	AK20X01	AK20X02	ASD-0440-0480-D5-FW40
ASI.M.4550.SG	○	45.50	6.35	AK20X00	AK20X01	AK20X02	ASD-0440-0480-D5-FW40
ASI.M.4600.SG	○	46.00	6.35	AK20X00	AK20X01	AK20X02	ASD-0440-0480-D5-FW40
ASI.M.4650.SG	○	46.50	6.35	AK20X00	AK20X01	AK20X02	ASD-0440-0480-D5-FW40
ASI.M.4700.SG	○	47.00	6.35	AK20X00	AK20X01	AK20X02	ASD-0440-0480-D5-FW40
ASI.M.4750.SG	○	47.50	6.35	AK20X00	AK20X01	AK20X02	ASD-0440-0480-D5-FW40
ASI.M.4800.SG	○	48.00	6.35	AK20X00	AK20X01	AK20X02	ASD-0440-0480-D5-FW40

DİŞ AÇMA UÇLARI VE TAKIMLARI

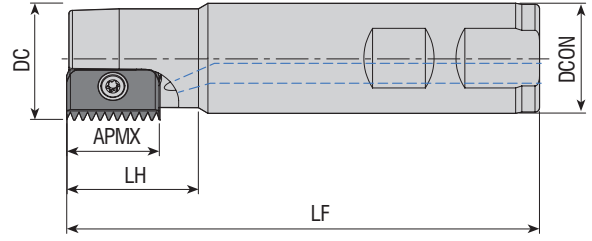
THREADING INSERTS AND TOOLS
GEWINDESCHNEIDPLATTEN UND WERKZEUGE





Takım Kodu Ordering Code Bestell-Bezeichnung	Stok Stock Lager	Takım Ölçüleri (mm) Dimension (mm) Abmessung (mm)						Kesici Uç Insert Wendeschneidplatte	Yedek Parçaları / Spare Parts / Ersatzteile	
		DC	ZEFP	DCON	LF	LH	APMX		Sıkma Vidası Screw Schraube	Tork Anahtar Torx Key Torx-Schlüssel
ATM-C14-D14-W20-L100-Z01-H	●	14	1	20	100	25	14			82-T08
ATM-C21-D18-W20-L100-Z01-H	●	18	1	20	100	30	21			
ATM-C21-D21-W25-L125-Z01-H	●	21	1	25	125	40	21			4015-M4x11
ATM-C21-D25-W20-L125-Z01-H	●	25	1	20	125	30	21			
ATM-C21-D28-W25-L90-Z01-H	●	28	1	25	90	30	21			
ATM-C21-D38-W32-L90-Z03-H	●	38	3	32	90	30	21			
ATM-C21-D38-W32-L120-Z03-H	●	38	3	32	120	30	21			
ATM-C21-D43-W32-L90-Z03-H	●	43	3	32	90	30	21		1020-M5x14	80-T20
ATM-C30-D29-W25-L150-Z01-H	●	29	1	25	150	50	30			

CPT Ucuna Uygunur. / Compatible with CPT Insert. / Kompatibel mit CPT Wendeplatten.

Sipariş Örneği/Ordering Example/Bestellbeispiel
 1 ad./pcs./stück ATM-C14-D14-W20-L100-Z01-H

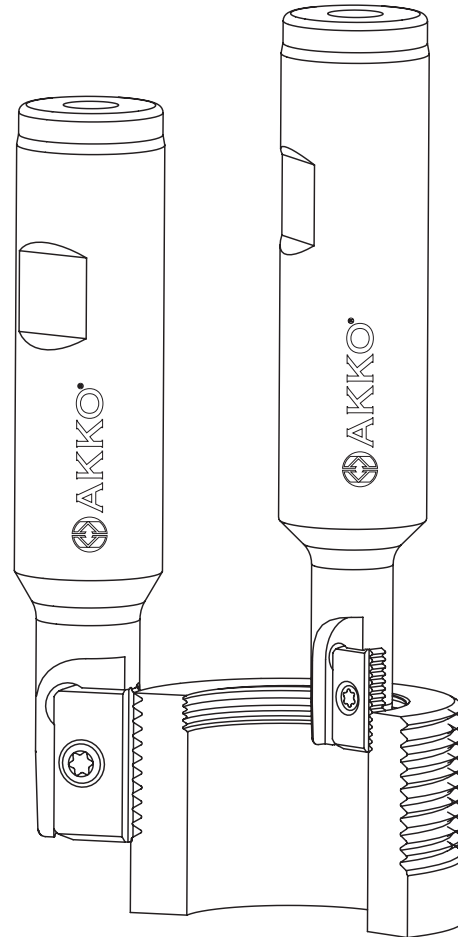

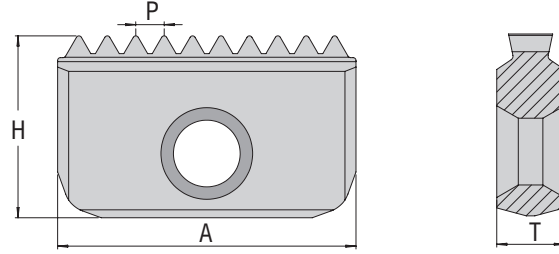
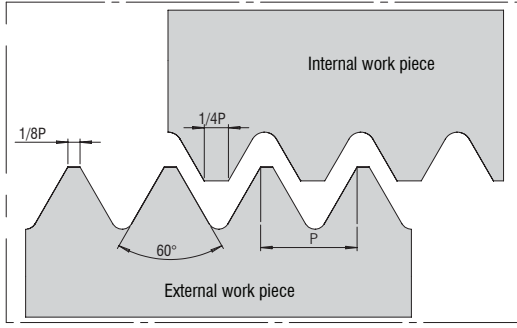

Ürün Kodu Product Code Artikelnummer	Insert Tipi Insert Type Wendepplatten Typ A	Takım Ölçüleri (mm) Dimension (mm) Abmessung (mm)		
		Adım Pitch Wendepplatten Typ P	H	T
ADTI14.050.M	C14	0.5	7.5	3.1
ADTI14.075.M		0.75	7.5	3.1
ADTE14.075.M		0.75	7.5	3.1
ADTI14.100.M		1.00	7.5	3.1
ADTE14.100.M		1.00	7.5	3.1
ADTI14.125.M		1.25	7.5	3.1
ADTE14.125.M		1.25	7.5	3.1
ADTI14.150.M		1.50	7.5	3.1
ADTE14.150.M		1.50	7.5	3.1
ADTI14.175.M		1.75	7.5	3.1
ADTE14.175.M		1.75	7.5	3.1
ADTI14.200.M		2.00	7.5	3.1
ADTE14.200.M		2.00	7.5	3.1
ADTI14.250.M		2.50	7.5	3.1
ADTE14.250.M		2.50	7.5	3.1

Ürün Kodu Product Code Artikelnummer	Insert Tipi Insert Type Wendepplatten Typ A	Takım Ölçüleri (mm) Dimension (mm) Abmessung (mm)		
		Adım Pitch Wendepplatten Typ P	H	T
ADTI21.100.M	C21	1.00	12	4.7
ADTE21.100.M		1.00	12	4.7
ADTI21.150.M		1.50	12	4.7
ADTE21.150.M		1.50	12	4.7
ADTI21.175.M		1.75	12	4.7
ADTI21.200.M		2.00	12	4.7
ADTE21.200.M		2.00	12	4.7
ADTI21.250.M		2.50	12	4.7
ADTE21.250.M		2.50	12	4.7
ADTI21.300.M		3.00	12	4.7
ADTE21.300.M		3.00	12	4.7
ADTI21.350.M		3.5	12	4.7

Sipariş Örneği/Ordering Example/Bestellbeispiel
 1 ad./pcs./stück ADTI14.050.M

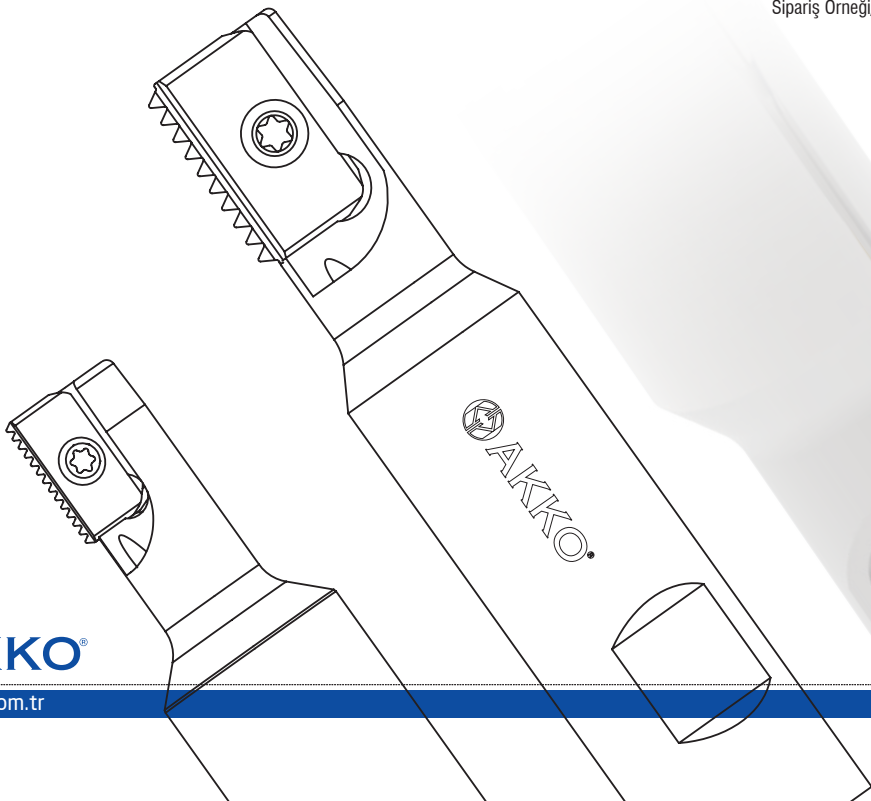

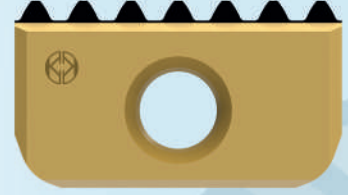
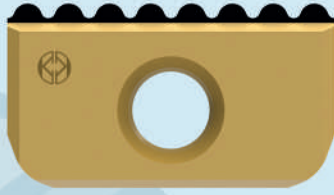

SPECIAL THREADING MILLING TOOLS

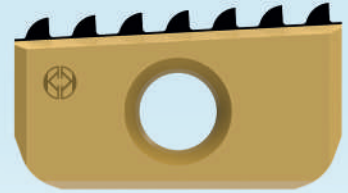
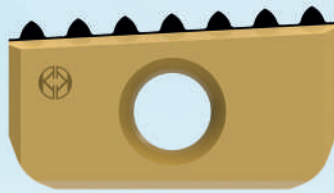
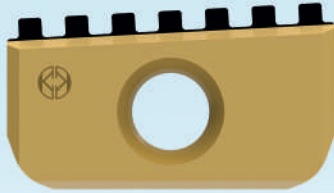

DİŞ TARAĞI BİLGİ ALMA FORMU

INFORMATION FORM FOR SPECIAL THREAD MILLING INSERTS
INFORMATIONSFÖRM FÜR SONDER GEWINDEFÄSERWERKZEUGE

Insert Type	Thread Type	Thread Pitch mm	Thread Profile
C 14	External <input type="checkbox"/> Internal <input type="checkbox"/> Nötr <input type="checkbox"/>		ISO <input type="checkbox"/> UN <input type="checkbox"/> WHIT <input type="checkbox"/> NPT <input type="checkbox"/> NPTF <input type="checkbox"/> BSPT <input type="checkbox"/> NPS <input type="checkbox"/> NPSF <input type="checkbox"/> PG <input type="checkbox"/>
C 21	External <input type="checkbox"/> Internal <input type="checkbox"/> Nötr <input type="checkbox"/>		ISO <input type="checkbox"/> UN <input type="checkbox"/> WHIT <input type="checkbox"/> NPT <input type="checkbox"/> NPTF <input type="checkbox"/> BSPT <input type="checkbox"/> NPS <input type="checkbox"/> NPSF <input type="checkbox"/> PG <input type="checkbox"/>



ROUND

Dış çap / External / Außen

EX-RH
IN-LH

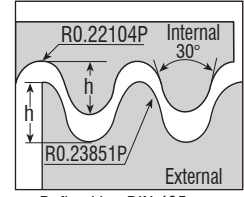
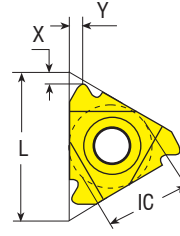

Defined by: DIN 405

Uç Kodu Insert Code

Wendeplatten-Bezeichnung

Stok
Stock
Lager

Uç Ölçüleri (mm)
Insert Dimension (mm)
Abmessung (mm)

R	L	IC	L	Adım / Pitch / Wendeplatten Typ	(TPI)	h	X	Y	UYUMLU TAKIM / COMPATIBLE TOOLHOLDER / KOMPATIBLES WERKZEUG
○	○	9.53	16	10		1.27	1.1	1.2	SER/L16C
○	○	9.53	16	8		1.59	1.4	1.3	
○	○	9.53	16	6		2.12	1.5	1.7	
○	○	13	22	6		2.12	1.5	1.7	SER/L22C
○	○	13	22	4		3.18	2.2	2.3	
○	○	15.88	27	4		3.18	2.2	2.3	
○	○	15.88	27	4		3.18	2.2	2.3	TER/L27



ROUND

İç çap / Internal / Innen

IN-RH
EX-LH

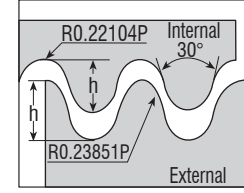
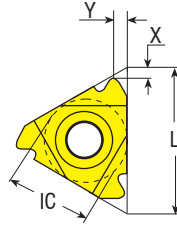

Defined by: DIN 405

Uç Kodu Insert Code

Wendeplatten-Bezeichnung

Stok
Stock
Lager

Uç Ölçüleri (mm)
Insert Dimension (mm)
Abmessung (mm)

R	L	IC	L	Adım / Pitch / Wendeplatten Typ	(TPI)	h	X	Y	UYUMLU TAKIM / COMPATIBLE TOOLHOLDER / KOMPATIBLES WERKZEUG
○	○	9.53	16	10		1.27	1.1	1.2	SIR/L 16C
○	○	9.53	16	8		1.59	1.4	1.3	
○	○	9.53	16	6		2.12	1.5	1.7	
○	○	13	22	6		2.12	1.5	1.7	SIR/L S... 22C
○	○	13	22	4		3.18	2.2	2.3	
○	○	15.88	27	4		3.18	2.2	2.3	
○	○	15.88	27	4		3.18	2.2	2.3	TIR/L S... 27

R: Sağ / Right / Rechts L: Sol / Left / Links

● Stokta / In Stock / Auf Lager ○ Stokta Yok / Non Stock Item / Kein Lagerartikel, Lieferzeit auf Anfrage

Sipariş Örneği/Ordering Example/Bestellbeispiel

1 ad./pcs./stück 16ST ER 10RD



TRAPEZ

Diş çap / External / Außen

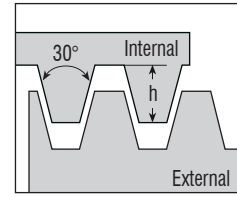
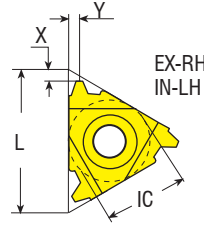

Defined by: DIN 103

Uç Kodu
Insert Code
Wendeplatten-Bezeichnung

Stok
Stock
Lager

Uç Ölçüleri (mm)
Insert Dimension (mm)
Abmessung (mm)

Uç Kodu Insert Code Wendeplatten-Bezeichnung	Stok Stock Lager		Uç Ölçüleri (mm) Insert Dimension (mm) Abmessung (mm)					UYUMLU TAKIM / COMPATIBLE TOOLHOLDER / KOMPATIBLES WERKZEUG	
	R	L	IC	L	Adım / Pitch / Wendeplatten Typ	h	X		Y
16ST ER/L 1.5TR	○	○	9.53	16	1.5	0.90	1.0	1.1	SER/L 2525 M16C-T
16ST ER/L 2.0TR	○	○	9.53	16	2.0	1.25	1.1	1.3	
16ST ER/L 2.5TR	○	○	9.53	16	2.5	1.55	1.2	1.4	
16ST ER/L 3.0TR	○	○	9.53	16	3.0	1.75	1.3	1.5	
22ST ER/L 4.0TR	○	○	13	22	4.0	2.25	1.7	1.9	SER/L 2525 M22C-T
22ST ER/L 5.0TR	○	○	13	22	5.0	2.75	2.1	2.5	
22ST ER/L 6.0TR	○	○	13	22	6.0	3.50	2.3	2.7	
27ST ER/L 6.0TR	○	○	15.88	27	6.0	3.50	2.3	2.7	TER/L27



TRAPEZ

Diş çap / External / Außen
V Tip / V Type / V Typ

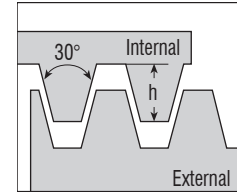
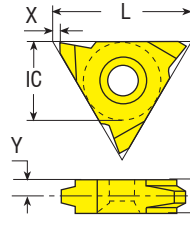

Defined by: DIN 103

Uç Kodu
Insert Code
Wendeplatten-Bezeichnung

Stok
Stock
Lager

Uç Ölçüleri (mm)
Insert Dimension (mm)
Abmessung (mm)

Uç Kodu Insert Code Wendeplatten-Bezeichnung	Stok Stock Lager		Uç Ölçüleri (mm) Insert Dimension (mm) Abmessung (mm)						
	R	L	IC	L	Adım / Pitch / Wendeplatten Typ	h	X	Y	S
27VT ER/L 6.0TR	○	○	15.88	27	6.0	3.50	1.0	3.3	6.38
27VT ER/L 7.0TR	○	○	15.88	27	7.0	4.00	1.0	3.3	6.38
27VT ER/L 8.0TR	○	○	15.88	27	8.0	4.50	1.0	3.3	6.38

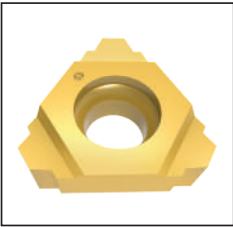

TRAPEZ

Diş çap / External / Außen
U Tip / U Type / U Typ

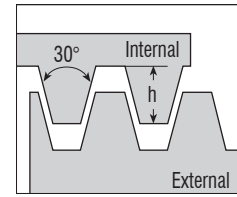
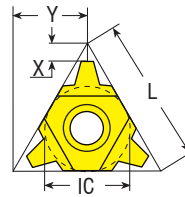

Defined by: DIN 103

Uç Kodu
Insert Code
Wendeplatten-Bezeichnung

Stok
Stock
Lager

Uç Ölçüleri (mm)
Insert Dimension (mm)
Abmessung (mm)

Uç Kodu Insert Code Wendeplatten-Bezeichnung	Stok Stock Lager		Uç Ölçüleri (mm) Insert Dimension (mm) Abmessung (mm)					
	R	L	IC	L	Adım / Pitch / Wendeplatten Typ	h	X	Y
22UT E 6.0TR	○	○	13	22	6.0	3.50	2.0	11.0
22UT E 7.0TR	○	○	13	22	7.0	4.0	2.3	11.0
22UT E 8.0TR	○	○	13	22	8.0	4.50	2.6	11.0
27UT E 8.0TR	○	○	15.88	27	8.0	4.50	2.6	13.7
27UT E 9.0TR	○	○	15.88	27	9.0	5.00	3.0	13.7

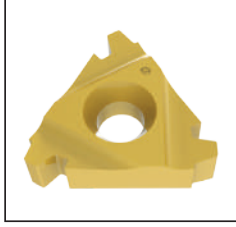

TRAPEZ
İç çap / Internal / Innen

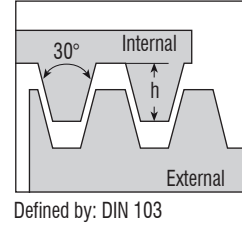
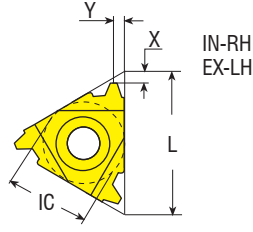

Defined by: DIN 103

Uç Kodu
Insert Code

Wendeplatten-Bezeichnung

Stok
Stock
Lager

Uç Ölçüleri (mm)
Insert Dimension (mm)
Abmessung (mm)

R	L	IC	L	Adım / Pitch / Wendeplatten Typ	h	X	Y	UYUMLU TAKIM / COMPATIBLE TOOLHOLDER / KOMPATIBLES WERKZEUG
○	○	9.53	16	1.5	0.90	1.0	1.1	SIR/L S25R 16C-T
○	○	9.53	16	2.0	1.25	1.1	1.3	
○	○	9.53	16	2.5	1.53	1.2	1.4	
○	○	9.53	16	3.0	1.75	1.3	1.5	
○	○	13	22	4.0	2.25	1.7	1.9	SIR/L S25R 22C-T
○	○	13	22	5.0	2.75	2.1	2.5	
○	○	13	22	6.0	3.50	2.3	2.7	
○	○	15.88	27	6.0	3.50	2.3	2.7	TIR/L S... 27

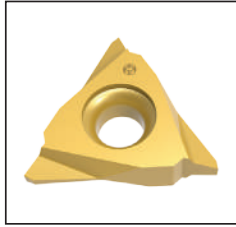

TRAPEZ
İç çap / Internal / Innen
V Tip / V Type / V Typ

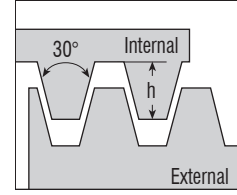
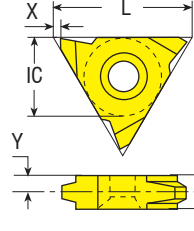

Defined by: DIN 103

Uç Kodu
Insert Code

Wendeplatten-Bezeichnung

Stok
Stock
Lager

Uç Ölçüleri (mm)
Insert Dimension (mm)
Abmessung (mm)

R	L	IC	L	Adım / Pitch / Wendeplatten Typ	h	X	Y	S
○	○	15.88	27	6.0	3.50	1.0	3.3	6.38
○	○	15.88	27	7.0	4.00	1.0	3.3	6.38
○	○	15.88	27	8.0	4.50	1.0	3.3	6.38

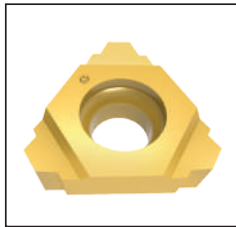

TRAPEZ
İç çap / Internal / Innen
U Tip / U Type / U Typ

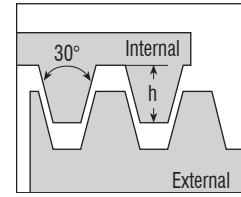
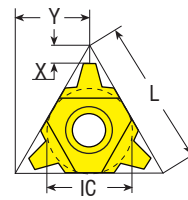

Defined by: DIN 103

Uç Kodu
Insert Code

Wendeplatten-Bezeichnung

Stok
Stock
Lager

Uç Ölçüleri (mm)
Insert Dimension (mm)
Abmessung (mm)

R	L	IC	L	Adım / Pitch / Wendeplatten Typ	h	X	Y
○	○	13	22	6.0	3.50	2.0	11.0
○	○	13	22	7.0	4.0	2.3	11.0
○	○	13	22	8.0	4.50	2.6	11.0
○	○	15.88	27	8.0	4.50	2.6	13.7
○	○	15.88	27	9.0	5.00	3.0	13.7

R: Sağ / Right / Rechts L: Sol / Left / Links

● Stokta / In Stock / Auf Lager ○ Stokta Yok / Non Stock Item / Kein Lagerartikel, Lieferzeit auf Anfrage

Sipariş Örneği/Ordering Example/Bestellbeispiel

1 ad./pcs./stück 216ST IR 1.5TR

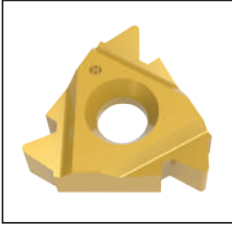

OIL AND GAS INDUSTRY

Diş çap / External / Außen

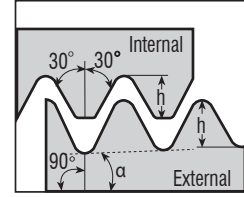
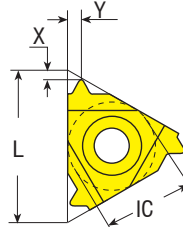

Defined by: API SPEC. 7:1990

Uç Kodu Insert Code

Wendeplatten-Bezeichnung

Stok
Stock
Lager

Uç Ölçüleri (mm)
Insert Dimension (mm)
Abmessung (mm)

R	L	Diş / Thread / Gewinde	IC	Adım / Pitch / (TPI) Wendeplatten Typ	Koniklik / Taper / Konisch	hmin	X	Y	Bağlantı numarası veya boyutu / Connection no. or size
○	○	V-0.038R	22	4	2	3.09	2.1	2.8	NC23-NC50
○	○	V-0.038R	22	4	3	3.08	2.1	2.8	NC56-NC77
○	○	V-0.050	22	4	2	3.75	2.0	2.9	6 5/8" REG, 5 1/2"FH, 6 5/8" FH
○	○	V-0.050	22	4	3	3.74	2.0	2.9	5 1/2", 7 5/8", 8 5/8" REG
○	○	V-0.040	22	5	3	2.99	1.8	2.6	2 3/8"-4 1/2" REG
○	○	V-0.055	22	6	1.5	1.41	2.6	2.0	NC10-NC16
○	○	V-0.038R	27	4	2	3.09	2.1	2.8	NC23-NC50
○	○	V-0.038R	27	4	3	3.08	2.1	2.8	NC56-NC77
○	○	V-0.050	27	4	2	3.75	2.1	3.1	6 5/8" REG, 5 1/2"FH, 6 5/8" FH
○	○	V-0.050	27	4	3	3.74	2.1	3.1	5 1/2", 7 5/8", 8 5/8" REG
○	○	V-0.040	27	5	3	2.99	1.9	2.7	2 3/8"-4 1/2" REG
○	○	V-0.065	27	4	2	2.81	2.3	2.8	2 3/8"IF- 5 1/2IF

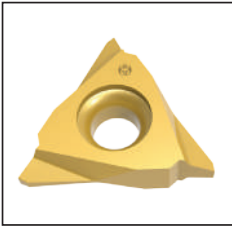

OIL AND GAS INDUSTRY

Diş çap / External / Außen
V Tip / V Type / V Typ

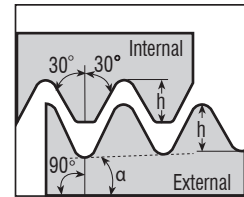
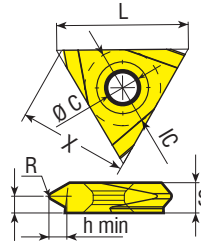

Defined by: API SPEC. 7:1990

Uç Kodu Insert Code

Wendeplatten-Bezeichnung

Stok
Stock
Lager

Uç Ölçüleri (mm)
Insert Dimension (mm)
Abmessung (mm)

R	L	Diş / Thread / Gewinde	IC	Adım / Pitch / (TPI) Wendeplatten Typ	Koniklik / Taper / Konisch	R	hmin	S	C	X	Y	Bağlantı numarası veya boyutu / Connection no. or size
○	○	V-0.040	27	5	3	0.51	3.00	6.38	6.20	23.4	3.9	2 3/8"-4 1/2" REG

R: Sağ / Right / Rechts L: Sol / Left / Links

● Stokta / In Stock / Auf Lager ○ Stokta Yok / Non Stock Item / Kein Lagerartikel, Lieferzeit auf Anfrage

Sipariş Örneği/Ordering Example/Bestellbeispiel

1 ad./pcs./stück 22ST ER 4APIV382

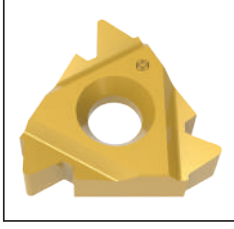

OIL AND GAS INDUSTRY
İç çap / Internal / Innen

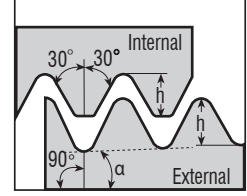
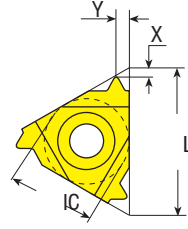

Defined by: API SPEC. 7:1990

Uç Kodu
Insert Code

Wendeplatten-Bezeichnung

Stok
Stock
Lager

Uç Ölçüleri (mm)
Insert Dimension (mm)
Abmessung (mm)

R	L	Diş / Thread / Gewinde	İC	Adım / Pitch / (TPI) Wendeplatten Typ	Koniklik / Taper / Konisch	hmin	X	Y	Bağlantı numarası veya boyutu / Connection no. or size
○	○	V-0.038R	22	4	2	3.09	2.1	2.8	NC23-NC50
○	○	V-0.038R	22	4	3	3.08	2.1	2.8	NC56-NC77
○	○	V-0.050	22	4	2	3.75	2.1	3.1	6 5/8" REG, 5 1/2" FH, 6 5/8" FH
○	○	V-0.050	22	4	3	3.74	2.0	2.9	5 1/2", 7 5/8", 8 5/8" REG
○	○	V-0.040	22	5	3	2.99	1.8	2.6	2 3/8"-4 1/2" REG
○	○	V-0.055	22	6	1.5	1.41	2.6	2.0	NC10-NC16
○	○	V-0.038R	27	4	2	3.09	2.1	2.8	NC23-NC50
○	○	V-0.038R	27	4	3	3.08	2.1	2.8	NC56-NC77
○	○	V-0.050	27	4	2	3.75	2.1	3.1	6 5/8" REG, 5 1/2" FH, 6 5/8" FH
○	○	V-0.050	27	4	3	3.74	2.1	3.1	5 1/2", 7 5/8", 8 5/8" REG
○	○	V-0.040	27	5	3	2.99	1.9	2.7	2 3/8"-4 1/2" REG
○	○	V-0.065	27	4	2	2.81	2.3	2.8	2 3/8" IF- 5 1/2 IF

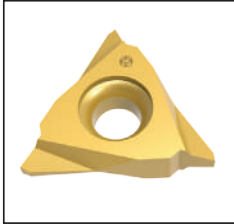

OIL AND GAS INDUSTRY
İç çap / Internal / Innen
V Tip / V Type / V Typ

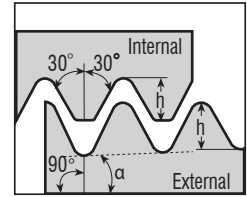
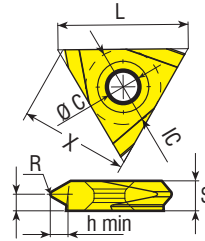

Defined by: API SPEC. 7:1990

Uç Kodu
Insert Code

Wendeplatten-Bezeichnung

Stok
Stock
Lager

Uç Ölçüleri (mm)
Insert Dimension (mm)
Abmessung (mm)

R	L	Diş / Thread / Gewinde	İC	Adım / Pitch / (TPI) Wendeplatten Typ	Koniklik / Taper / Konisch	R	hmin	S	C	X	Y	Bağlantı numarası veya boyutu / Connection no. or size
○	○	V-0.040	27	5	3	0.51	3.00	6.38	6.20	23.4	3.9	2 3/8"-4 1/2" REG

R: Sağ / Right / Rechts L: Sol / Left / Links

● Stokta / In Stock / Auf Lager ○ Stokta Yok / Non Stock Item / Kein Lagerartikel, Lieferzeit auf Anfrage

Sipariş Örneği/Ordering Example/Bestellbeispiel

1 ad./pcs./stück 27VT IR 5API403

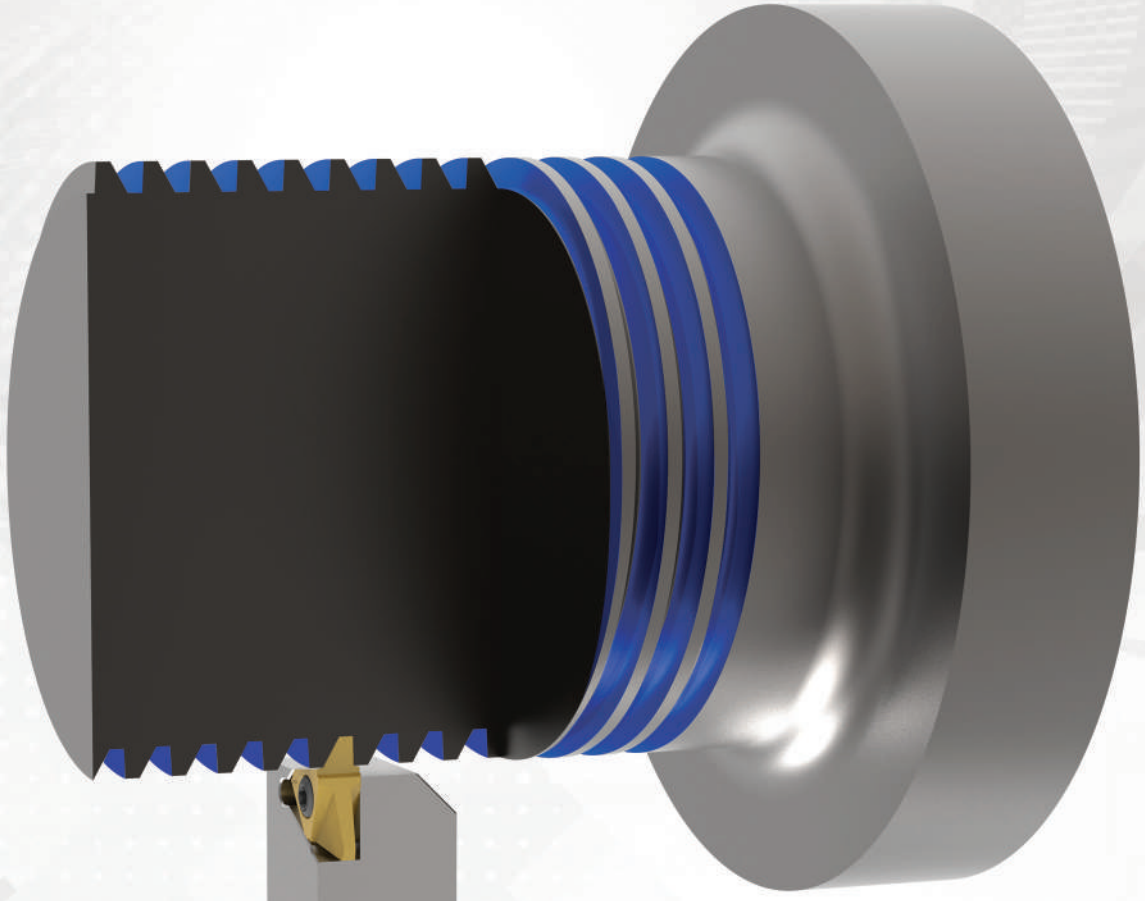

- **DIŞ AÇMA
ÖZEL ÇÖZÜMLER**
- **THREAD MILLING
SPECIAL SOLUTIONS**
- **GEWINDE LÖSUNGEN**

www.akkco.com.tr



AKKO®

DIŞ AÇMA ÇÖZÜMLERİ
THREADING SOLUTIONS
GEWINDE LÖSUNGEN

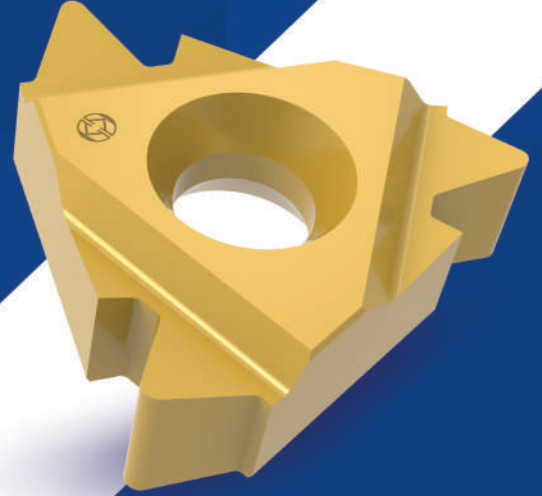
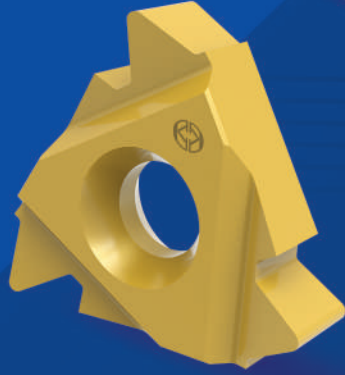
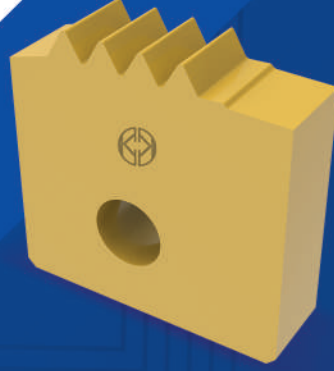
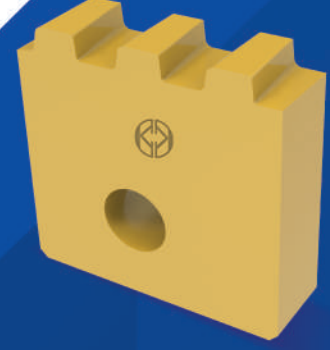

DIŞ AÇMA ÇÖZÜMLERİ
THREADING SOLUTIONS
GEWINDE LÖSUNGEN



MINI DIŞ FREZELEME
SOLID THREAD MILLING
SOLIDE GEWINDEFRESEN



MINI CUT ÖZEL DIŞ AÇMA
MINI CUT SPECIAL THREADING
SPEZIELLES GEWINDESCHNEIDEN MINI CUT

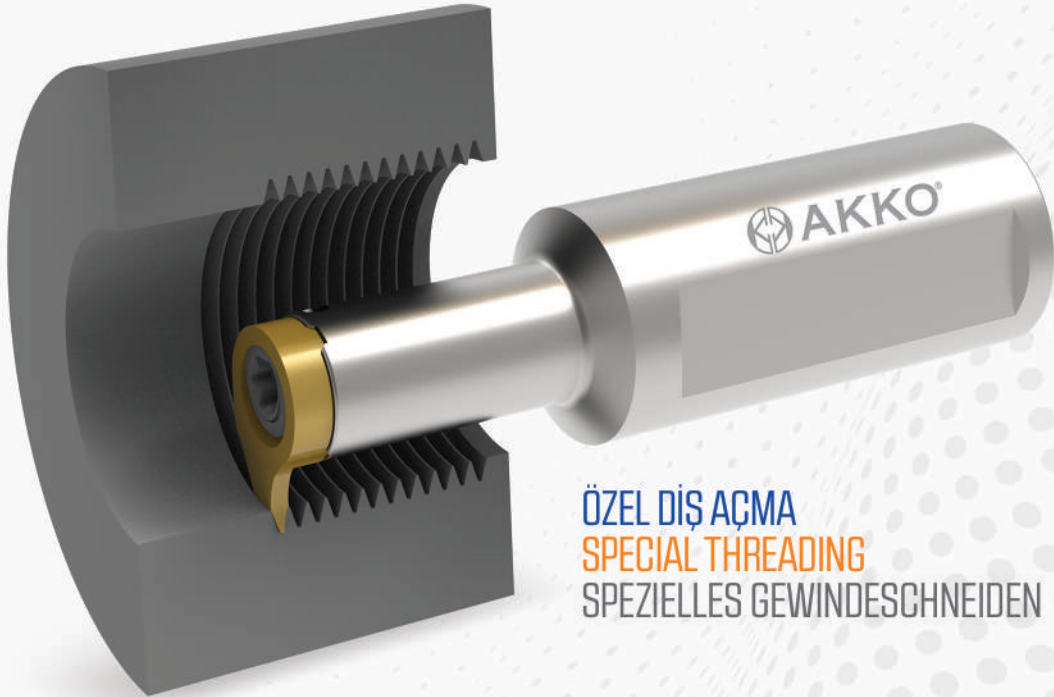

ÖZEL DIŞ AÇMA
SPECIAL THREADING
SPEZIELLES GEWINDESCHNEIDEN



AKKO® SOLUTIONS
Lösungen



ÖZEL FORM KANAL AÇMA ÇÖZÜMÜ
SPECIAL FORM GROOVING SOLUTIONS
LÖSUNGEN ZUM EINSTECHDREHEN IN SONDERFORMEN

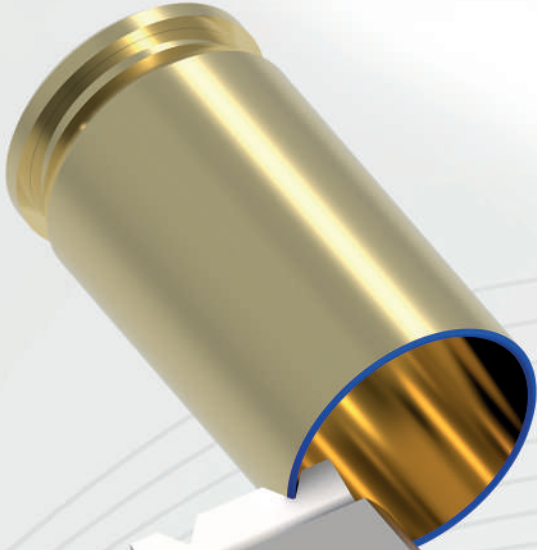
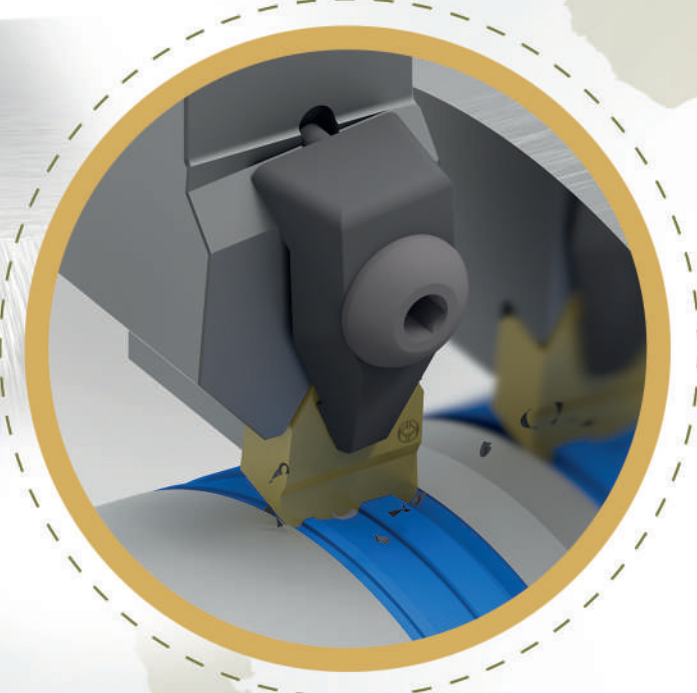
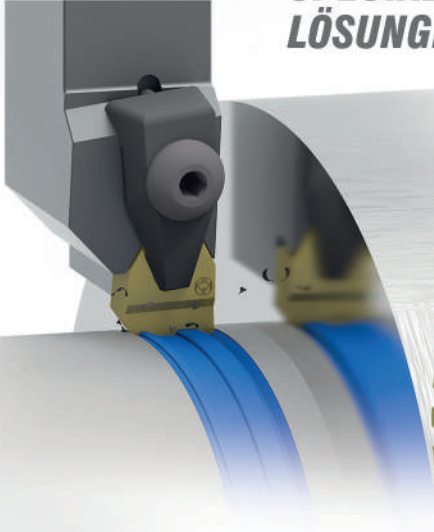

ÖZEL TALAŞLI İMALAT ÇÖZÜMLERİ
SPECIAL MACHINING SOLUTIONS
SONDERLÖSUNGEN FÜR MASCHINEN

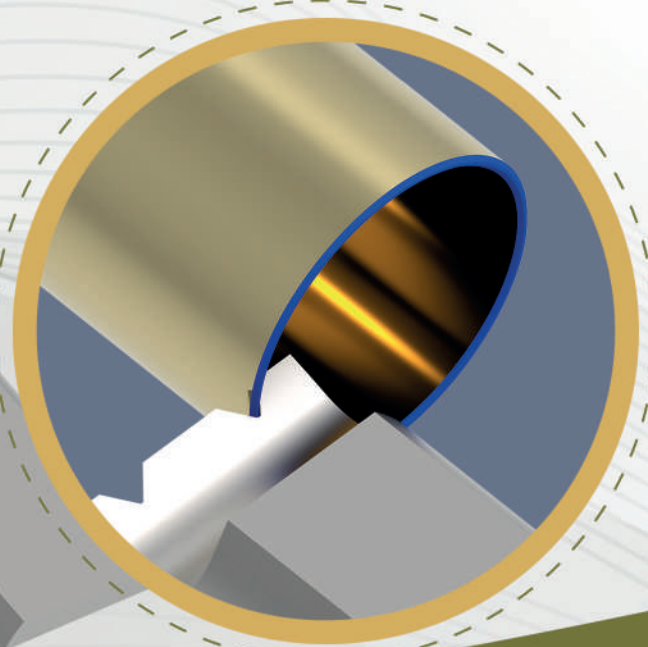



ÖZEL FORM KANAL AÇMA ÇÖZÜMÜ
SPECIAL FORM GROOVING SOLUTIONS
LÖSUNGEN ZUM EINSTECHDREHEN IN SONDERFORMEN

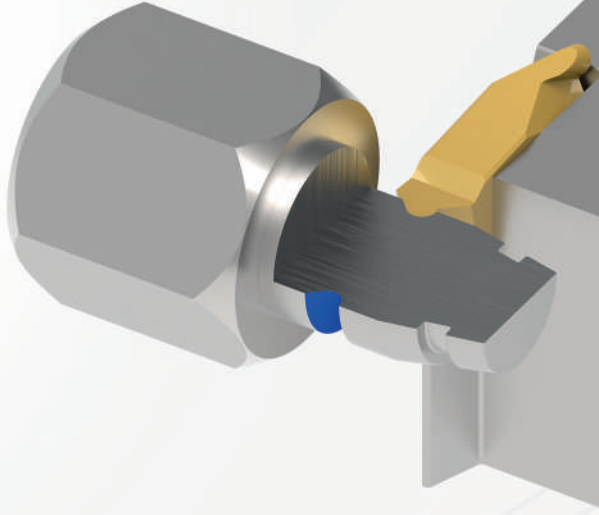



Cözümleri
AKKO® SOLUTIONS
Lösungen



ÖZEL FORM FREZELEME ÇÖZÜMLERİ
SPECIAL FORM MILLING SOLUTIONS
LÖSUNGEN FÜR SONDERFORMEN
ZUM FRÄSEN

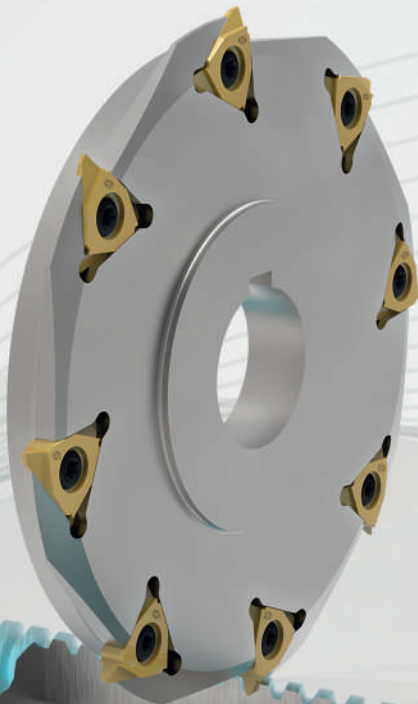
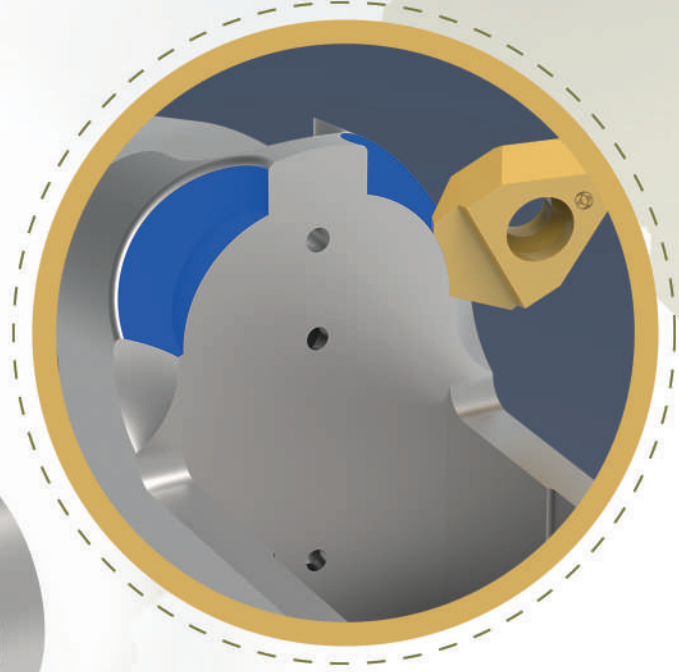
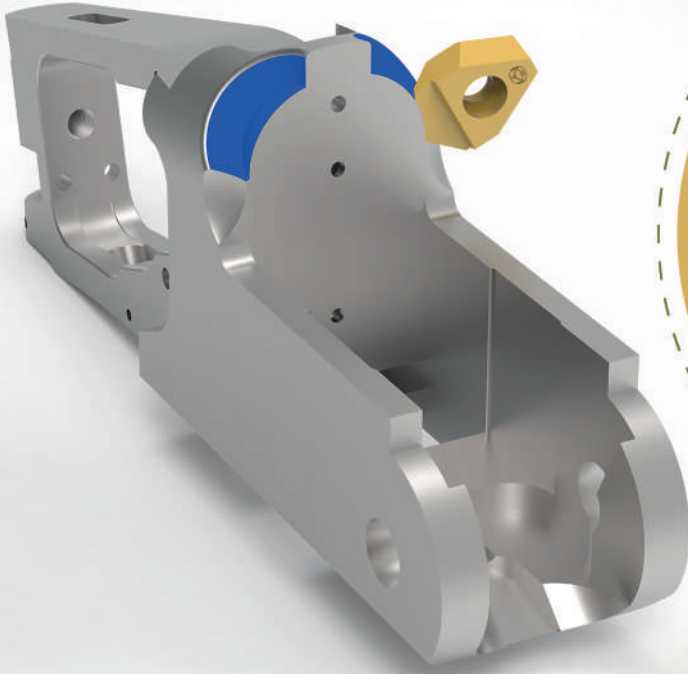

SONSUZ DİŞLİ FREZELEME ÇÖZÜMLERİ
SPECIAL MACHINING SOLUTIONS
LÖSUNGEN ZUM FRÄSEN MIT
ZAHNSTANGENGETRIEBE



ÖZEL FORM FREZELEME ÇÖZÜMLERİ
SPECIAL FORM MILLING SOLUTIONS
LÖSUNGEN FÜR SONDERFORMEN
ZUM FRÄSEN

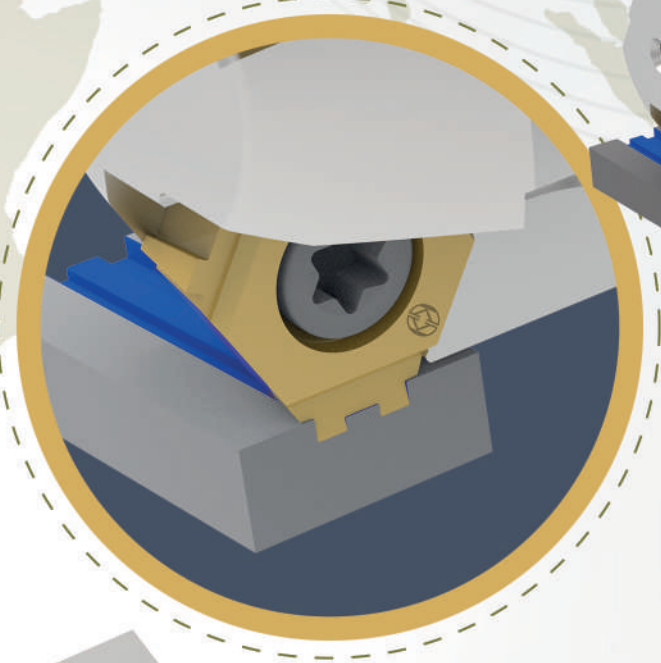
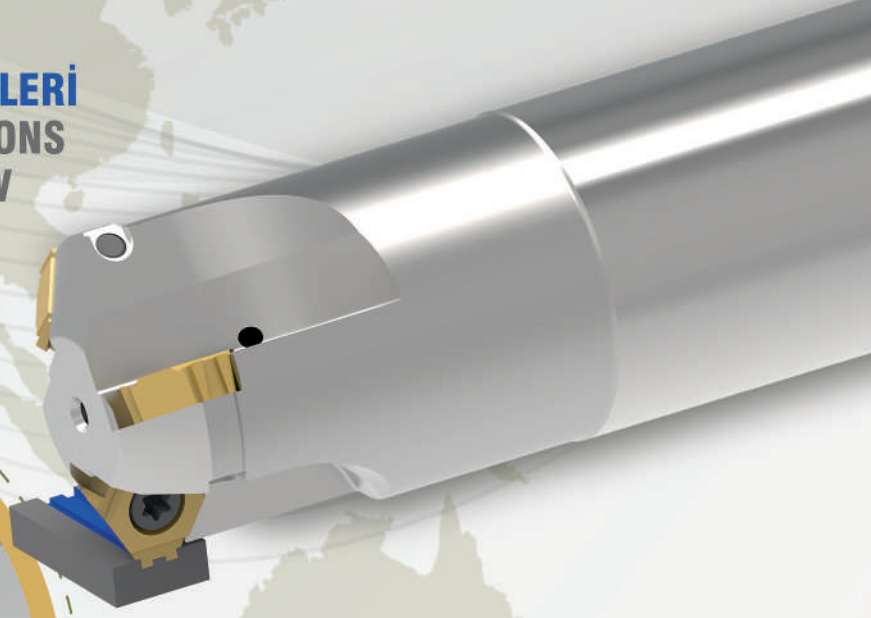

ÖZEL SUPAP ÇÖZÜMLERİ
SPECIAL VALVE SOLUTIONS
SPEZIELLE VENTILLÖSUNGEN





HELİSEL ÖZEL FORM AÇMA ÇÖZÜMLERİ
HELICAL SPECIAL FORMING SOLUTIONS
HELIX SONDERFORMEBEARBEITUNGSLÖSUNGEN

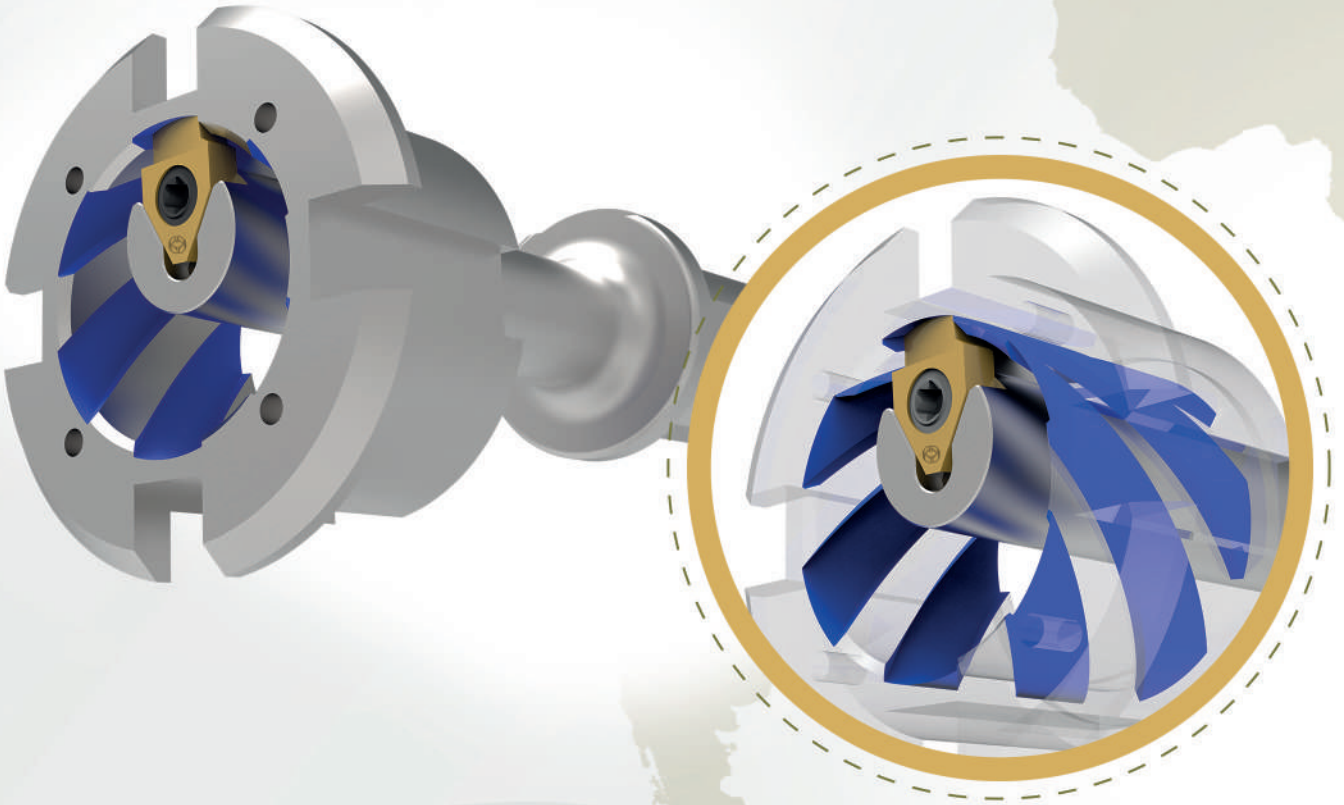

ÖZEL TAKIMLANDIRMA ÇÖZÜMLERİ
SPECIAL MACHINING SOLUTIONS
SONDERLÖSUNGEN FÜR
WERKZEUGHALTER





PETROL SONDAJ BORULARI DIŐ ÇEKME ÇÖZÜMLERİ
SPECIAL FORM MILLING SOLUTIONS
LÖSUNGEN MIT EINFÄDELWERKZEUG
FÜR ÖL-GAS ROHREN

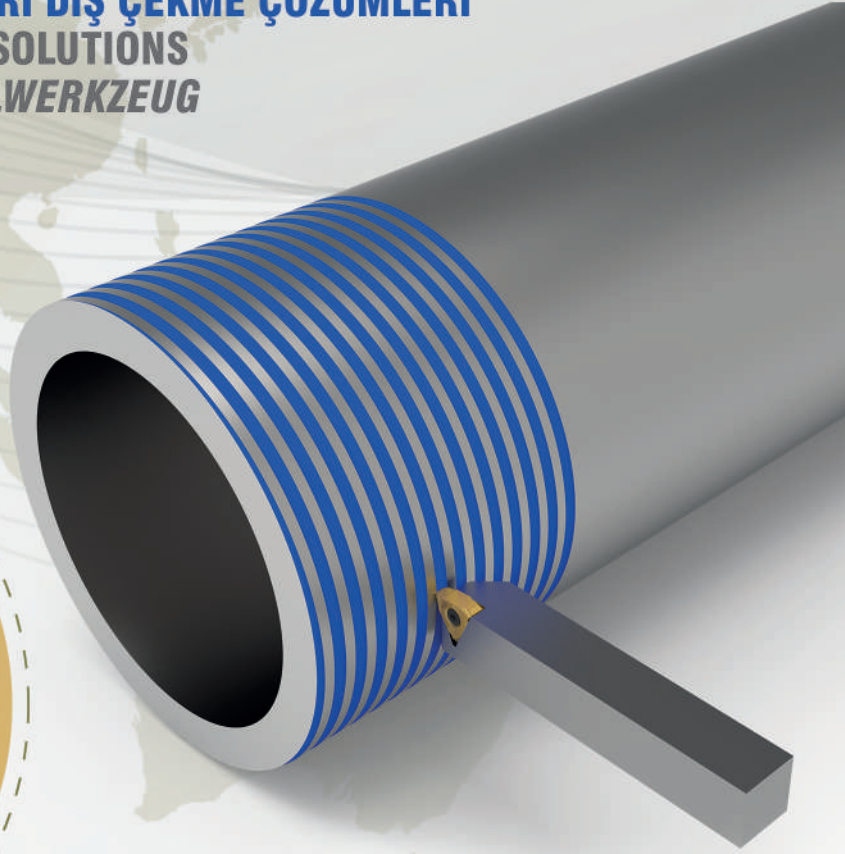

ÖZEL FORM DIŐ ÇEKME ÇÖZÜMLERİ
SPECIAL FORM THREADING SOLUTIONS
LÖSUNGEN ZUM GEWINDEDREHEN
VON SONDERFORMEN



AKKO®

Cözümleri

SOLUTIONS

Lösungen



STICK BLADE – KONVOID BLADE KONİK DIŞLİ AÇMA ÇÖZÜMLERİ

STICK BLADE – KONVOID BLADE BEVEL GEAR SOLUTIONS

LÖSUNGEN FÜR STICK BLADE- KONVOID BLADE MIT KEGELRADGETRIEBE

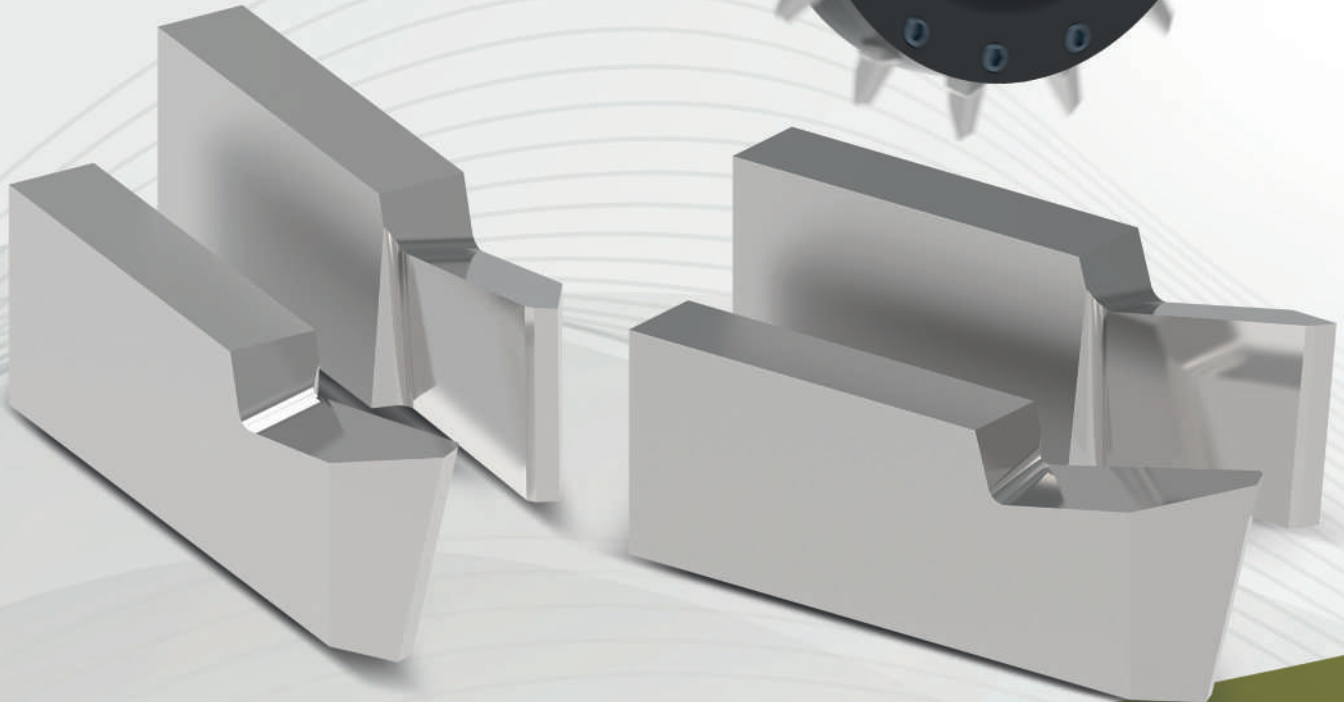
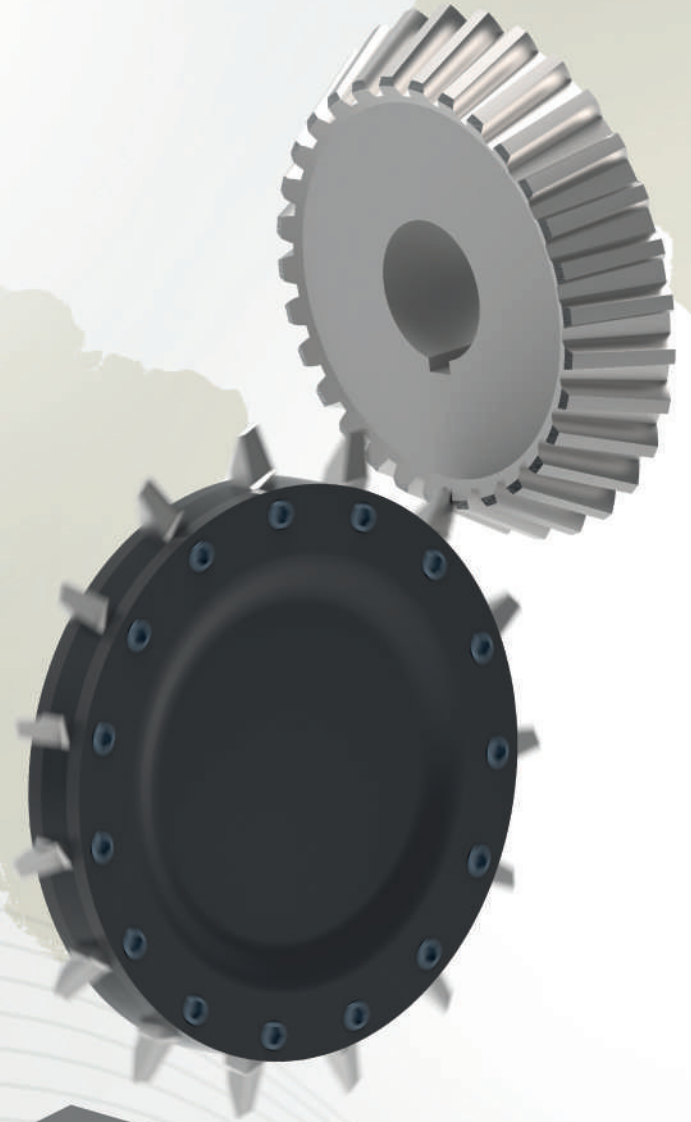
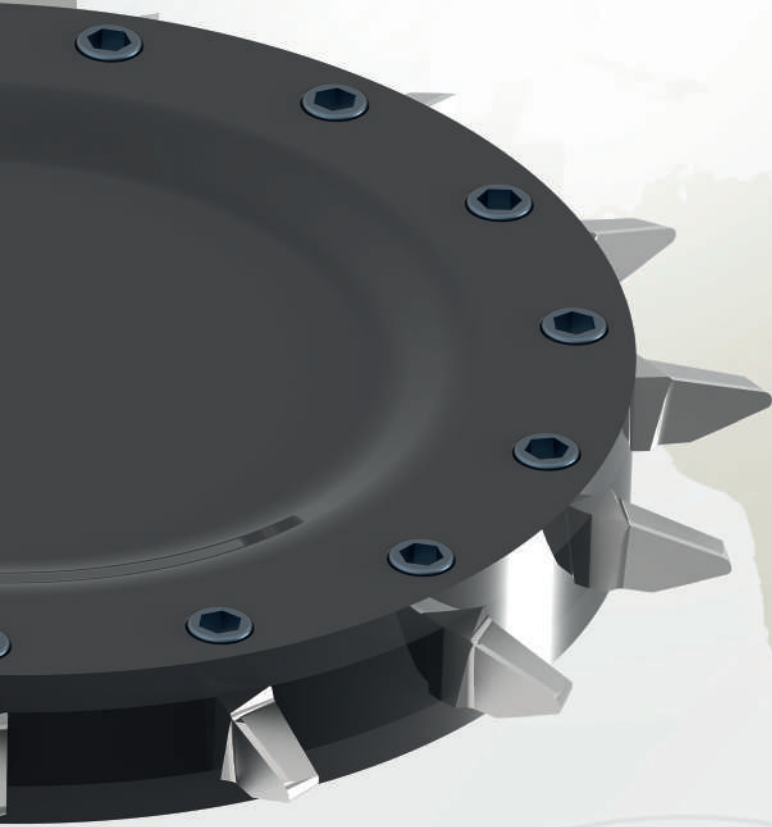



ZİNCİR DİŞLİ BROŞ ÇÖZÜMLERİ
CHAIN SPROCKETS BROACHING SOLUTIONS
LÖSUNGEN MIT KETTENFORM
ZUR NUTUNGSBEARBEITUNGEN

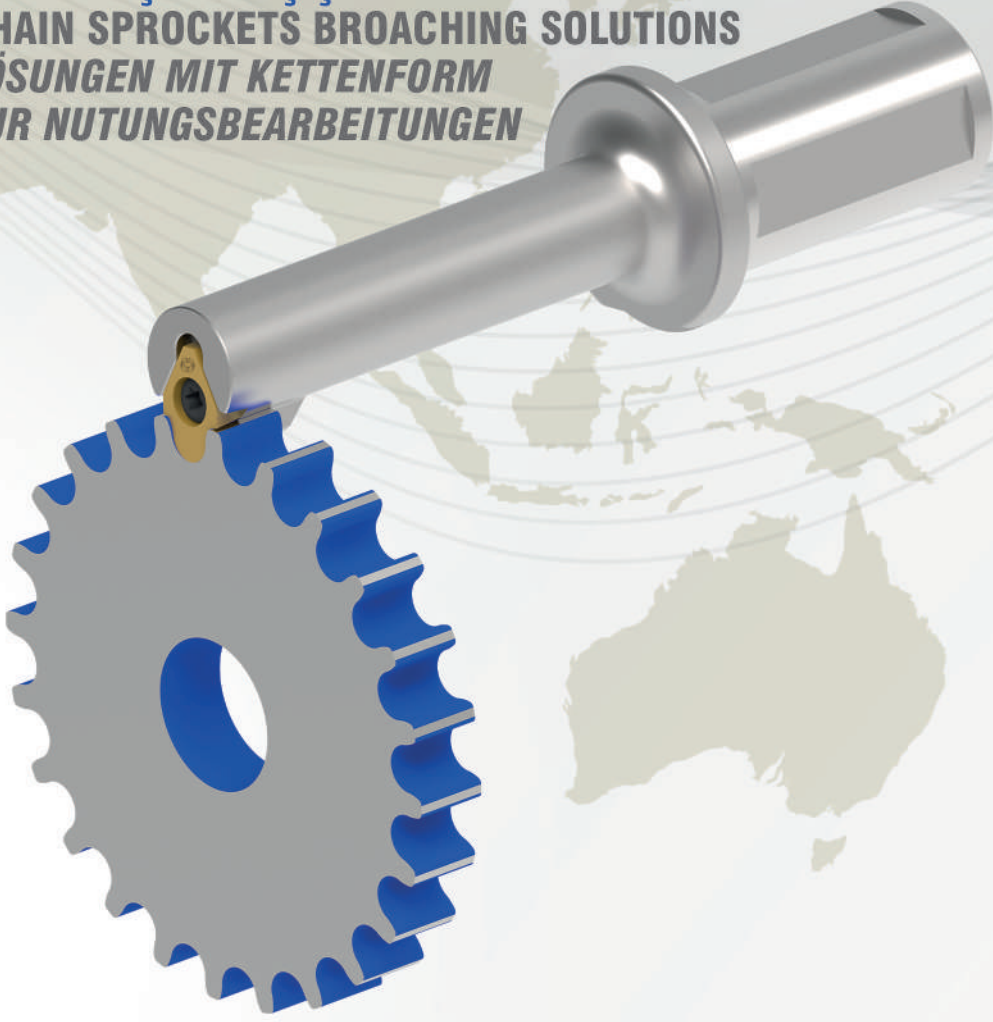

SONSUZ DİŞLİ TORNALAMA ÇÖZÜMLERİ
WORM GEAR TURNING SOLUTIONS
DREHLÖSUNGEN MIT ZAHNSTANGENGETRIEBE

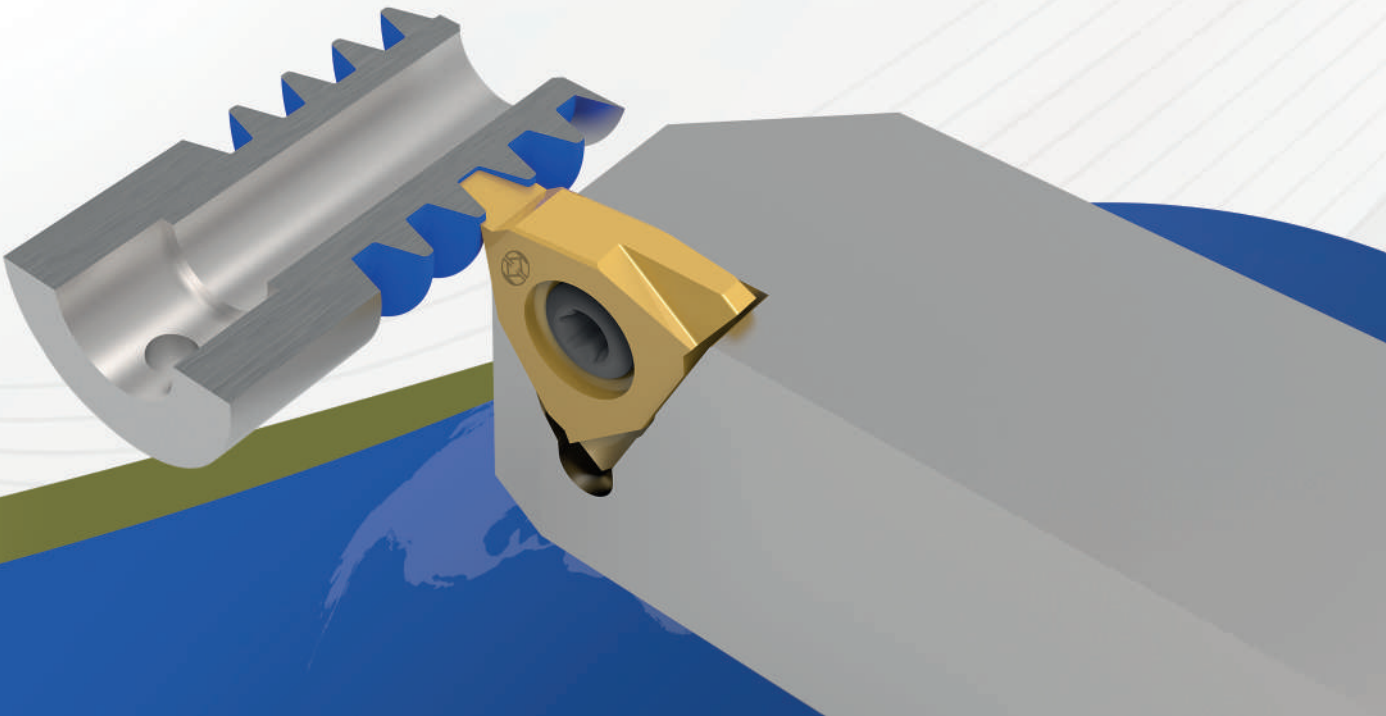



ÖZEL DIŞLİ PROFİL BROŞ ÇÖZÜMLERİ
GEAR PROFILE BROACHING SOLUTION
LÖSUNGEN ZUM RÄUMEN VON
ZAHNRADPROFILEN

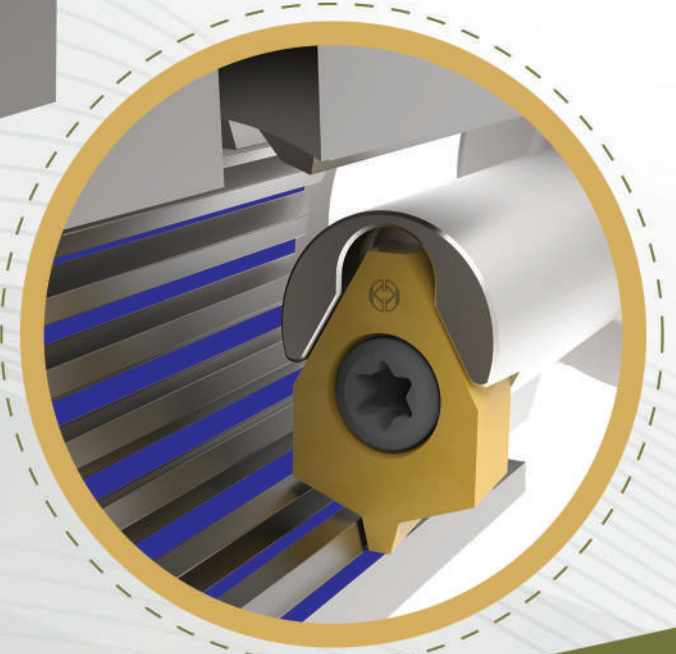
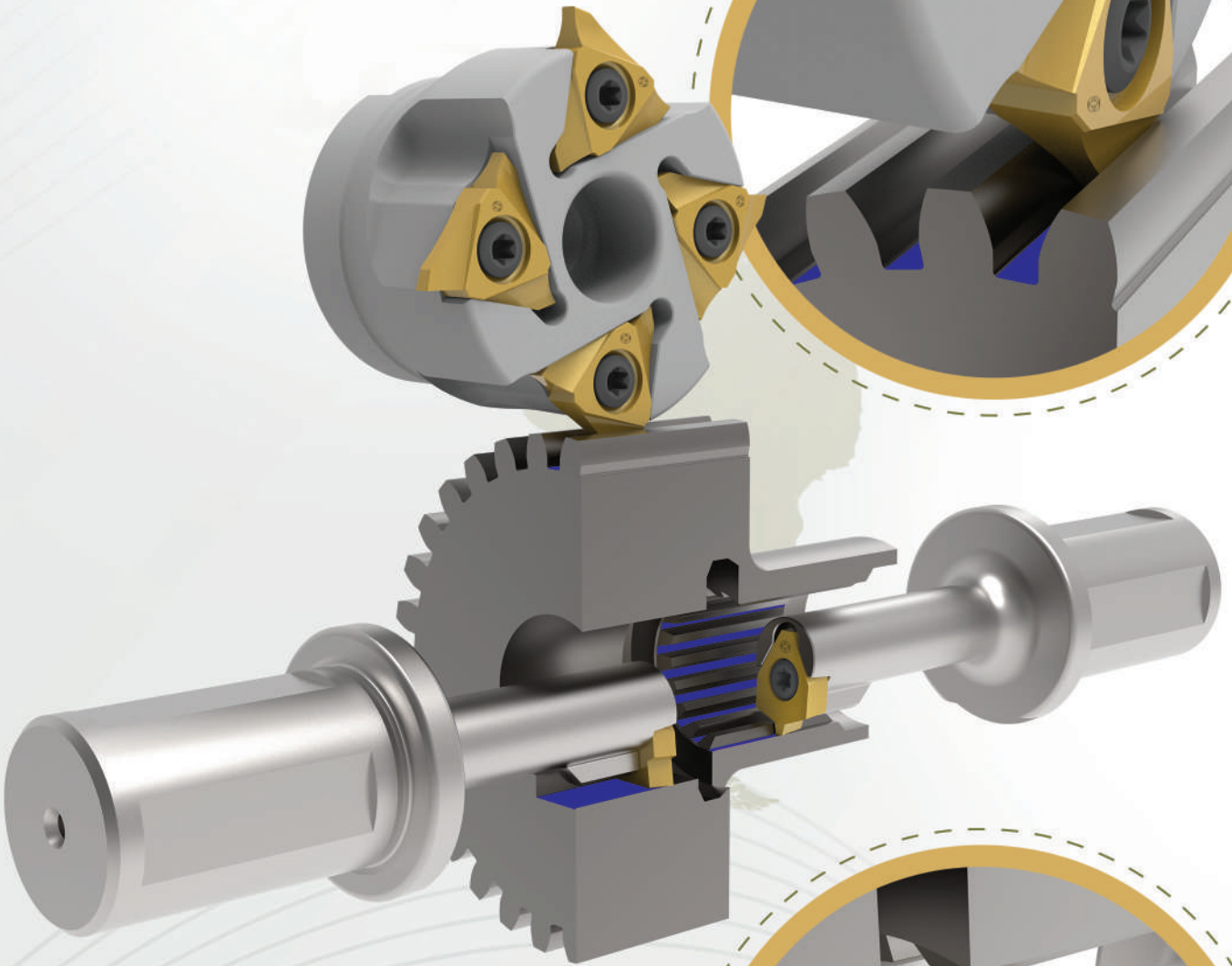



ÖZEL DIŞLİ PROFİL BROŞ ÇÖZÜMLERİ
GEAR PROFILE BROACHING SOLUTION
LÖSUNGEN ZUM RÄUMEN VON
ZAHNRADPROFILEN

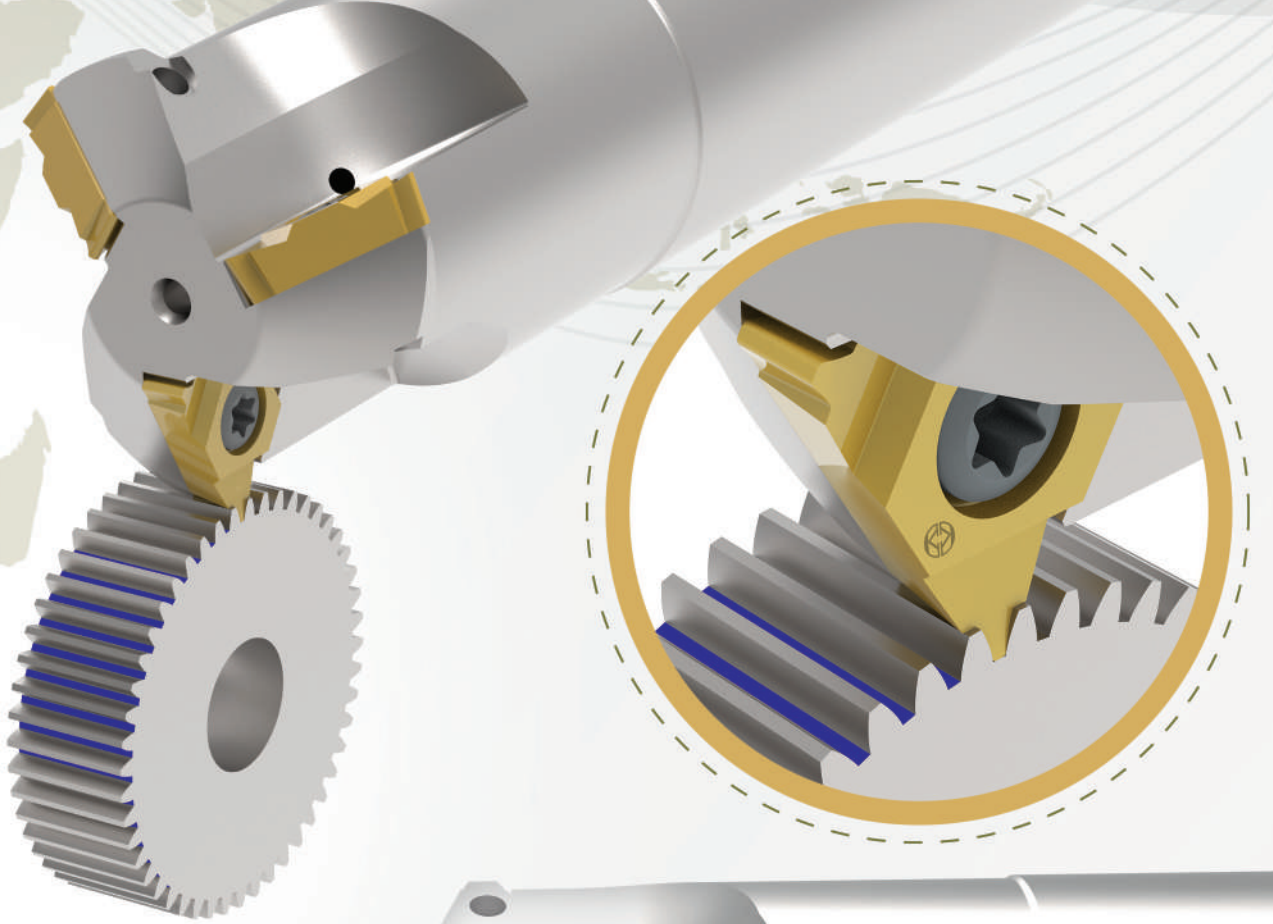

SUPAP

SUPAP YUVASI İŞLEME UÇLARI ve TAKIMLARI
VALVE SEAT INSERTS and TOOLHOLDERS
WENDESCHNEIDPLATTEN UND WERKZEUGE FÜR
VENTILSITZBEARBEITUNG

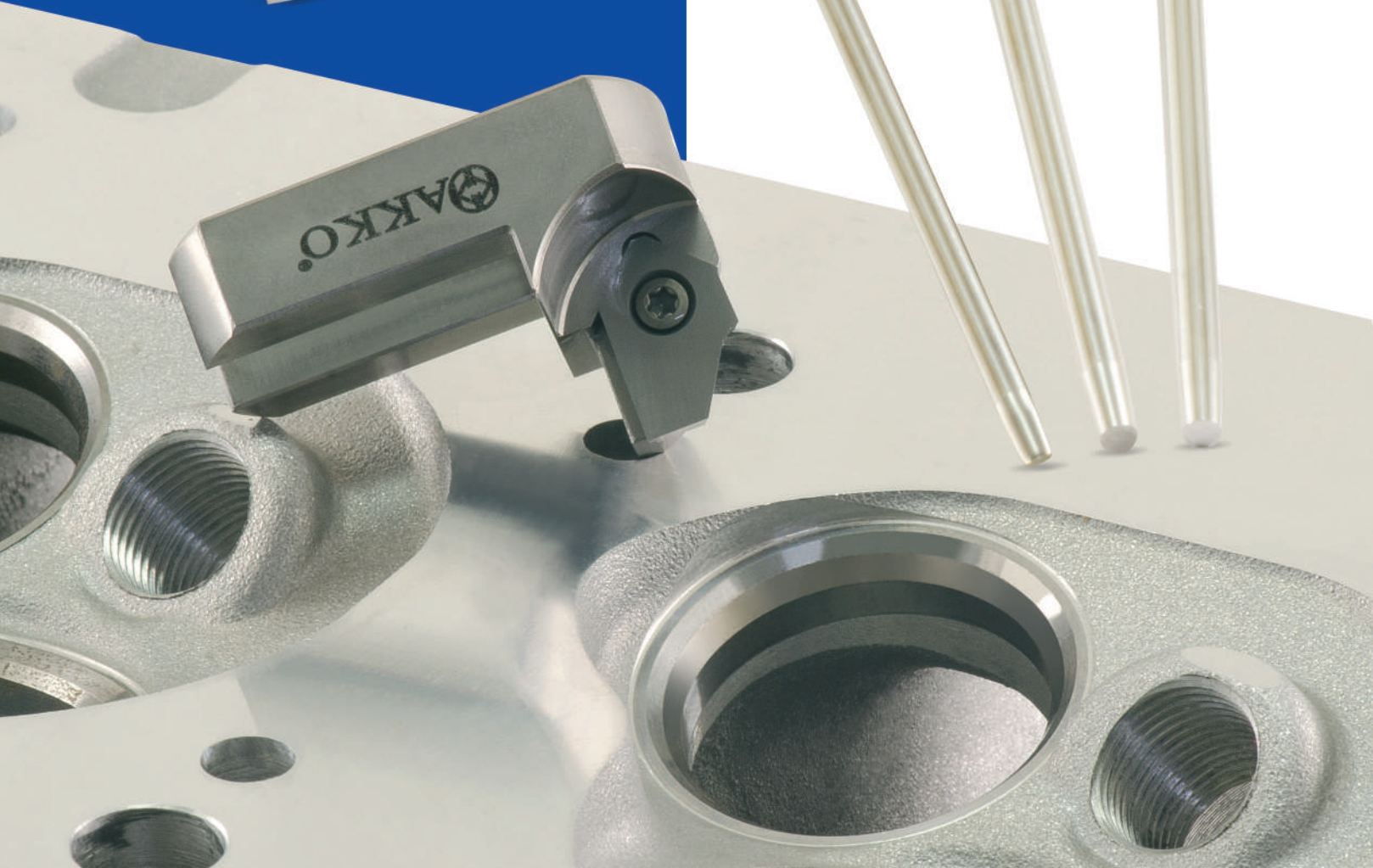
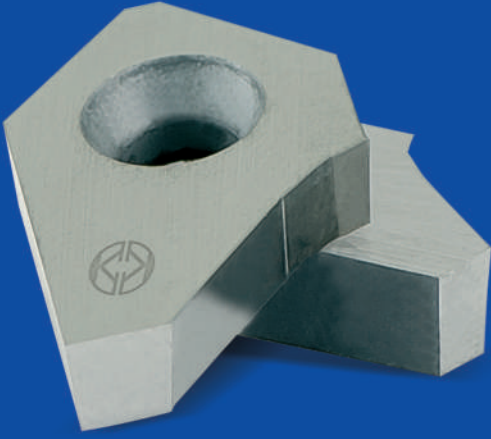

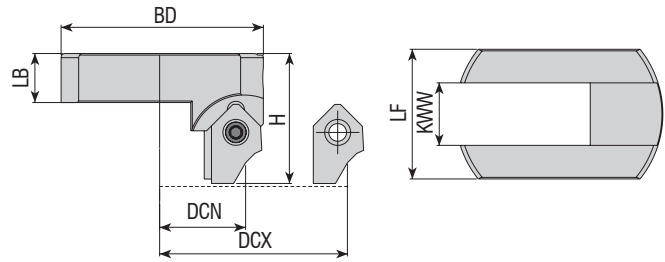

Takım Kodu Ordering Code Bestell-Bezeichnung	Stok Stock Lager	Takım Ölçüleri (mm) Dimension (mm) Abmessung (mm)						Kesici Uç Insert Wendeschneidplatte	Yedek Parçaları / Spare Parts / Ersatzteile			
		DCN DCX	BD	LB	H	KWW	LF		Sıkma Vidası Screw Schraube	Tork Anahtar Torx Key Torx-Schlüssel	Ayar Vidası Adjustable Einstellschraube	Anahtar Allen Key Innensechskantschlüssel
VST-B11-2842	●	28-42	29	9.5	28.5	12	25.0					
VST-B11-4058	●	40-58	39	9.5	25.0	12	25.0	B11...	3008-M3x8	80-T08	2725-M5x10	AAL-01-02

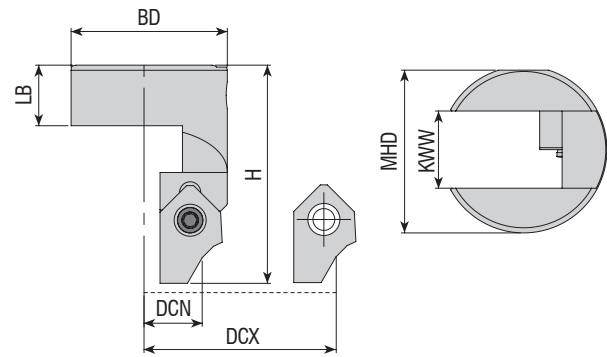

Takım Kodu Ordering Code Bestell-Bezeichnung	Stok Stock Lager	Takım Ölçüleri (mm) Dimension (mm) Abmessung (mm)						Kesici Uç Insert Wendeschneidplatte	Yedek Parçaları / Spare Parts / Ersatzteile			
		DCN DCX	BD	LB	H	KWW	MHD		Sıkma Vidası Screw Schraube	Tork Anahtar Torx Key Torx-Schlüssel	Ayar Vidası Adjustable Einstellschraube	Anahtar Allen Key Innensechskantschlüssel
VST-B11-1830-A	●	18-30	24	9.5	34.0	12	25.3					

R: Sağ / Right / Rechts L: Sol / Left / Links

● Stokta / In Stock / Auf Lager ○ Stokta Yok / Non Stock Item / Kein Lagerartikel, Lieferzeit auf Anfrage

Sipariş Örneği/Ordering Example/Bestellbeispiel

1 ad./pcs./stück VST-B11-2842

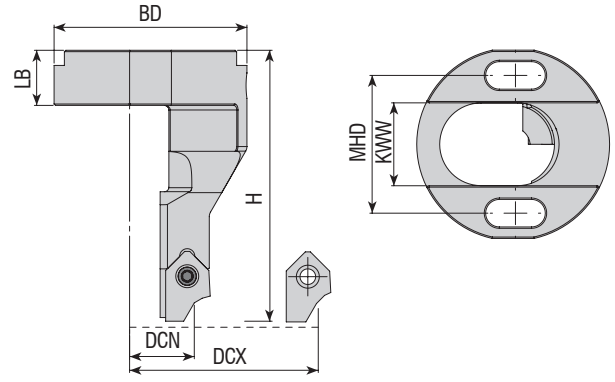

Takım Kodu Ordering Code Bestell-Bezeichnung	Stok Stock Lager	Takım Ölçüleri (mm) Dimension (mm) Abmessung (mm)						Kesici Uç Insert Wendeschneidplatte	Yedek Parçaları / Spare Parts / Ersatzteile							
		DCN DCX	BD	LB	H	KWW	MHD		Sıkma Vidası Screw Schraube	Tork Anahtar Torx Key Torx-Schlüssel	Ayar Vidası Adjustable Einstellschraube	Anahtar Allen Key Innensechskantschlüssel				
VST-B11-2032-A	●	20-32	42	12	59	18	30	B11...								
VST-B11-2434-A	●	24-34	26	14	40	11	18.1						3008-M3x8	80-T08	2702-M4x10	AAL-01-02
VST-B11-2956-A	●	26-56	49	11.7	43.7	18	40									

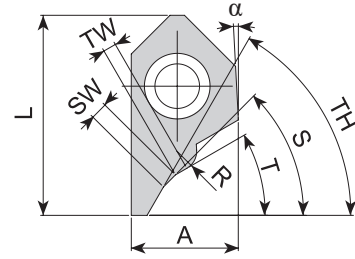
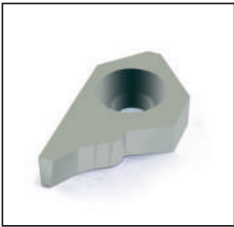

Uç Kodu Insert Code Wendepplatten-Bezeichnung	Stok Stock Lager	Uç Ölçüleri (mm) Insert Dimension (mm) Abmessung (mm)									
		S°	SW	T°	TW	TH°	A	L	α	R	
B11013	●	45°	1.3	30°	1	60°	8.15	15.10	3°	1.50	

R: Sağ / Right / Rechts L: Sol / Left / Links
● Stokta / In Stock / Auf Lager ○ Stokta Yok / Non Stock Item / Kein Lagerartikel, Lieferzeit auf Anfrage

Sipariş Örneği/Ordering Example/Bestellbeispiel
1 ad./pcs./stück VST-B11-2032

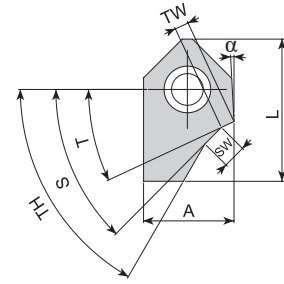

Uç Kodu
Insert Code
Wendepplatten-Bezeichnung

Stok
Stock
Lager

Uç Ölçüleri (mm)
Insert Dimension (mm)
Abmessung (mm)

		S°	SW	T°	TW	TH°	A	L	α
B11003	●	45°	1.3	25°	1.1	52°	9.7	15.25	3°
B11004	●	45°	1.6	25°	1.3	52°	9.7	15.25	3°
B11005	●	45°	2	25°	1.3	52°	9.7	15.25	3°
B11006	●	45°	2.5	25°	1.5	52°	9.7	15.25	3°
B11007	●	45°	1.5	30°	1.5	60°	9.7	15.25	3°
B11008	●	45°	1.3	25°	1.1	60°	9.7	15.25	3°
B11009	●	45°	1.6	25°	1.3	60°	9.7	15.25	3°
B11010	●	45°	2	25°	1.3	60°	9.7	15.25	3°
B11011	●	30°	2	15°	1.8	60°	9.7	15.25	3°
B11012	●	36°	2	15°	1.6	60°	9.7	15.25	3°
B11014	●	45°	2.5	25°	1.5	60°	9.7	15.25	3°
B11016	●	30°	1.5	15°	1.3	60°	9.7	15.25	3°
B11017	●	30°	2.5	15°	1.8	60°	9.7	15.25	3°
B11018	●	36°	2.5	15°	1.6	60°	9.7	15.25	3°
B11019	●	20°	2.5	10°	2	75°	9.7	15.25	3°
B11020	●	45°	1.3	25°	1.1	52°	7.7	15.25	3°
B11021	●	30°	3	15°	1.8	60°	9.7	15.25	3°
B11022	●	45°	3	30°	1.8	60°	9.7	15.25	3°
B11029	●	40°	2.5	25°	1.5	60°	9.7	15.25	3°
B11030	●	20°	2	10°	1.3	60°	9.7	15.25	3°
B11031	●	45°	1.8	30°	1.3	60°	9.7	15.25	3°
B11032	●	45°	1.5	30°	1	52°	9.7	15.25	3°
B11033	●	45°	2	30°	1.1	52°	9.7	15.25	3°
B11034	●	45°	2.5	30°	1.3	52°	9.7	15.25	3°
B11035	●	30°	1.5	15°	1	45°	9.7	15.25	3°
B11036	●	30°	2	15°	1.1	45°	9.7	15.25	3°
B11037	●	30°	2.5	15°	1.3	45°	9.7	15.25	3°
B11038	●	25°	2	15°	2	45°	9.7	15.25	3°
B11039	●	30°	2	15°	1.4	60°	9.7	15.25	3°
B11040	●	40°	2	15°	2	60°	9.7	15.25	3°
B11042	●	45°	1	30°	1.2	60°	9.7	15.25	3°
B11043	●	45°	1	35°	1.6	52°	9.7	15.25	3°
B11044	●	45°	1.3	30°	1	60°	9.7	15.25	3°
B11045	●	45°	1.5	30°	1	60°	9.7	15.25	3°
B11046	●	45°	1.8	30°	1	60°	9.7	15.25	3°
B11047	●	45°	1.8	30°	1.6	60°	9.7	15.25	3°
B11048	●	45°	1	25°	1.4	60°	9.7	15.25	3°
B11049	●	45°	1.50	25°	1.4	60°	9.7	15.25	3°
B11050	●	45°	2	25°	1.4	60°	9.7	15.25	3°

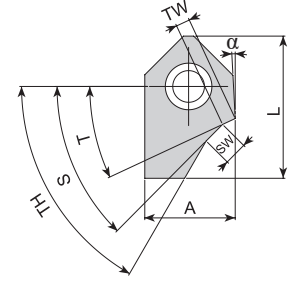

Uç Kodu Insert Code Wendeplatten-Bezeichnung	Stok Stock Lager	Uç Ölçüleri (mm) Insert Dimension (mm) Abmessung (mm)							
		S ⁰	SW	T ⁰	TW	TH ⁰	A	L	α
B11051	●	45°	3	25°	1.4	60°	9.7	15.25	3°
B11052	●	30°	1.5	15°	1.4	60°	9.7	15.25	3°
B11053	●	30°	2.5	15°	1.8	60°	9.7	15.25	3°
B11054	●	45°	1	15°	1	60°	9.7	15.25	3°
B11055	●	45°	1.5	30°	1.8	60°	9.7	15.25	3°
B11056	●	45°	2	30°	1.2	60°	9.7	15.25	3°
B11058	●	35°	2	15°	1.6	60°	9.7	15.25	3°
B11061	●	45°	1	25°	1.0	60°	7.7	15.25	3°
B11062	●	30°	1.3	15°	1.0	52°	7.7	15.25	3°
B11063	●	38°	2.5	15°	1.60	60°	9.7	15.25	3°
B11064	●	30°	2	15°	1.40	60°	9.7	15.25	3°
B11065	●	45°	1	25°	0.8	52°	7.7	15.25	3°
B11066	●	20°	3	10°	2.0	75°	9.7	15.25	3°
B11069	●	30°	3	15°	1.8	45°	9.7	15.25	3°
B11070	●	45°	1.2	32°	1	60°	8.15	15.10	3°
B11071	●	45°	1	32°	1	60°	8.15	15.10	3°
B11074	●	45°	1.5	30°	1.4	60°	9.7	15.25	3°
B11075	●	45°	2	15°	1	60°	9.7	15.25	3°
B11076	●	30°	1.90	15°	1	45°	9.7	15.25	3°
B11077	●	30°	2.5	15°	1.4	60°	9.7	15.25	3°
B11078	●	45°	1.6	30°	1.4	60°	9.7	15.25	3°
B11079	●	30°	1.3	15°	2.0	45°	9.7	15.25	3°
B11080	●	30°	1.8	15°	2.0	45°	9.7	15.25	3°
B11081	●	30°	3.0	15°	2.0	45°	9.7	15.25	3°
B11082	●	45°	1.0	30°	2.0	60°	9.7	15.25	3°
B11083	●	45°	1.1	30°	2.0	60°	9.7	15.25	3°
B11084	●	45°	1.2	30°	2.0	60°	9.7	15.25	3°
B11085	●	45°	1.3	30°	2.0	60°	9.7	15.25	3°
B11086	●	45°	1.6	30°	2.0	60°	9.7	15.25	3°
B11087	●	45°	2.0	30°	2.0	60°	9.7	15.25	3°
B11088	●	45°	2.5	30°	2.0	60°	9.7	15.25	3°
B11089	●	35°	2.0	15°	1.5	70°	9.7	15.25	3°
B11090	●	35°	2.5	15°	2.5	70°	9.7	15.25	3°
B11091	●	25°	2.5	15°	2.0	45°	9.7	15.25	3°
new B11096	●	45°	1.0	25°	1.8	60°	9.7	15.25	3°
new B11095	●	45°	1.5	25°	1.1	52°	7.7	15.25	3°

R: Sağ / Right / Rechts L: Sol / Left / Links

● Stokta / In Stock / Auf Lager ○ Stokta Yok / Non Stock Item / Kein Lagerartikel, Lieferzeit auf Anfrage

Sipariş Örneği/Ordering Example/Bestellbeispiel

1 ad./pcs./stück B11051

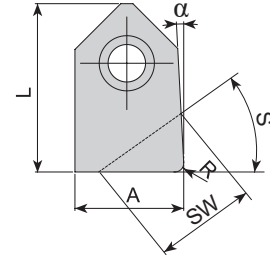

Uç Kodu
Insert Code
Wendeplatten-Bezeichnung

Stok
Stock
Lager

Uç Ölçüleri (mm)
Insert Dimension (mm)
Abmessung (mm)

		S°	SW	A	L	α	R
B11015	●	0°	9.85	9.85	15.10	3°	0.80
B11023	●	0°	7.7	7.7	15.10	3°	0.80
B11024	●	20°	8.2	9.75	15.10	3°	-
B11025	●	25°	10	9.65	15.10	3°	-
B11026	●	30°	9	9.65	15.10	3°	-
B11027	●	35°	10	9.6	15.10	3°	-
B11028	●	45°	8.9	9.55	15.10	3°	-
B11057	●	0°	9.6	9.7	14.8	1°	0.2
B11067	●	0°	9.9	9.7	15.10	3°	0.2
B11073	●	36°	10	9.7	15.10	3°	-
B11092	●	15°	8.2	9.5	15.10	3°	-
B11093	●	60°	8.4	9.5	15.10	3°	-
new B11094	●	0°	9.6	9.6	12.0	4°	0.80

R: Sağ / Right / Rechts L: Sol / Left / Links

● Stokta / In Stock / Auf Lager ○ Stokta Yok / Non Stock Item / Kein Lagerartikel, Lieferzeit auf Anfrage

Sipariş Örneği/Ordering Example/Bestellbeispiel

1 ad./pcs./stück B11015

SUPAP UCU BİLGİ ALMA FORMU
INFORMATION REQUEST FORM FOR VALVE SEAT INSERTS
INFORMATIONSFÖRMULAR FÜR VENTILSITZE

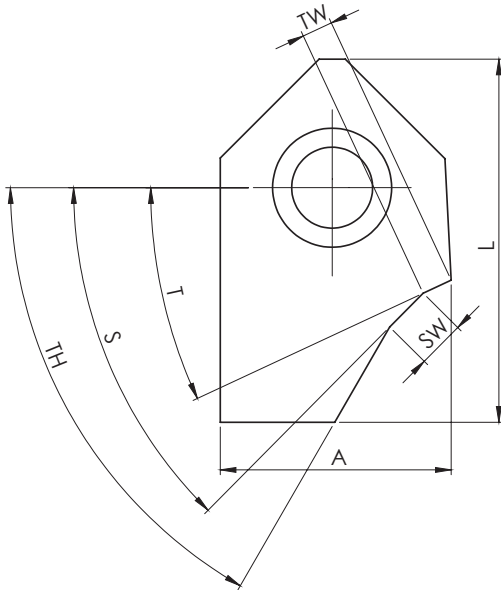

TW :	
L :	
SW :	
A :	
T° :	
S° :	
TH° :	
İLETİŞİM İÇİN: CONTACT: KONTAKT:	

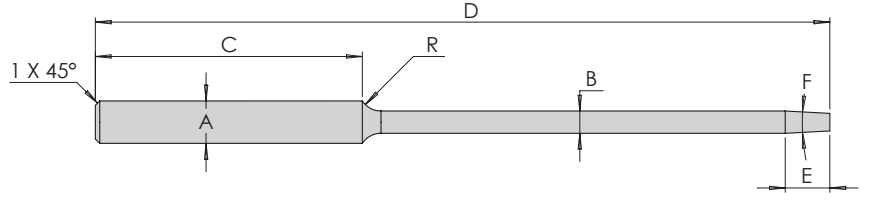

Uç Kodu
Insert Code
Wendepplatten-Bezeichnung

Stok
Stock
Lager

Uç Ölçüleri (mm)
Insert Dimension (mm)
Abmessung (mm)

Uç Kodu Insert Code Wendepplatten-Bezeichnung	Stok Stock Lager	Ø B (h7)	C	R	D	Ø A (h6)	E	F
ACPM-0497-165	●	4.97	60	5	165	9.525	10	6°
ACPM-0498-165	●	4.98	60	5	165	9.525	10	6°
ACPM-0499-165	●	4.99	60	5	165	9.525	10	6°
ACPM-0500-165	●	5.00	60	5	165	9.525	10	6°
ACPM-0549-165	●	5.49	60	5	165	9.525	10	6°
ACPM-0550-165	●	5.50	60	5	165	9.525	10	6°
ACPM-0597-165	●	5.97	60	5	165	9.525	10	6°
ACPM-0598-165	●	5.98	60	5	165	9.525	10	6°
ACPM-0599-165	●	5.99	60	5	165	9.525	10	6°
ACPM-0600-165	●	6.00	60	5	165	9.525	10	6°
ACPM-0605-165	●	6.05	60	5	165	9.525	10	6°
ACPM-0606-165	●	6.06	60	5	165	9.525	10	6°
ACPM-0659-165	●	6.59	60	5	165	9.525	10	6°
ACPM-0660-165	●	6.60	60	5	165	9.525	10	6°
ACPM-0697-165	●	6.97	60	5	165	9.525	10	6°
ACPM-0698-165	●	6.98	60	5	165	9.525	10	6°
ACPM-0699-165	●	6.99	60	5	165	9.525	10	6°
ACPM-0700-165	●	7.00	60	5	165	9.525	10	6°
ACPM-0797-165	●	7.97	60	5	165	9.525	10	6°
ACPM-0798-165	●	7.98	60	5	165	9.525	10	6°
ACPM-0799-165	●	7.99	60	5	165	9.525	10	6°
ACPM-0800-165	●	8.00	60	5	165	9.525	10	6°
ACPM-0801-165	●	8.01	60	5	165	9.525	10	6°
ACPM-0802-165	●	8.02	60	5	165	9.525	10	6°
ACPM-0803-165	●	8.03	60	5	165	9.525	10	6°
ACPM-0824-165	●	8.24	60	5	165	9.525	10	6°
ACPM-0825-165	●	8.25	60	5	165	9.525	10	6°
ACPM-0849-165	●	8.49	60	5	165	9.525	10	6°
ACPM-0850-165	●	8.50	60	5	165	9.525	10	6°
ACPM-0897-165	●	8.97	60	5	165	9.525	10	6°
ACPM-0898-165	●	8.98	60	5	165	9.525	10	6°
ACPM-0899-165	●	8.99	60	5	165	9.525	10	6°
ACPM-0900-165	●	9.00	60	5	165	9.525	10	6°

R: Sağ / Right / Rechts L: Sol / Left / Links

● Stokta / In Stock / Auf Lager ○ Stokta Yok / Non Stock Item / Kein Lagerartikel, Lieferzeit auf Anfrage

Sipariş Örneği/Ordering Example/Bestellbeispiel

1 ad./pcs./stück ACPM-0497-165

ÖZEL PROFİL KESİCİ UÇLAR SPECIAL CUTTING INSERTS

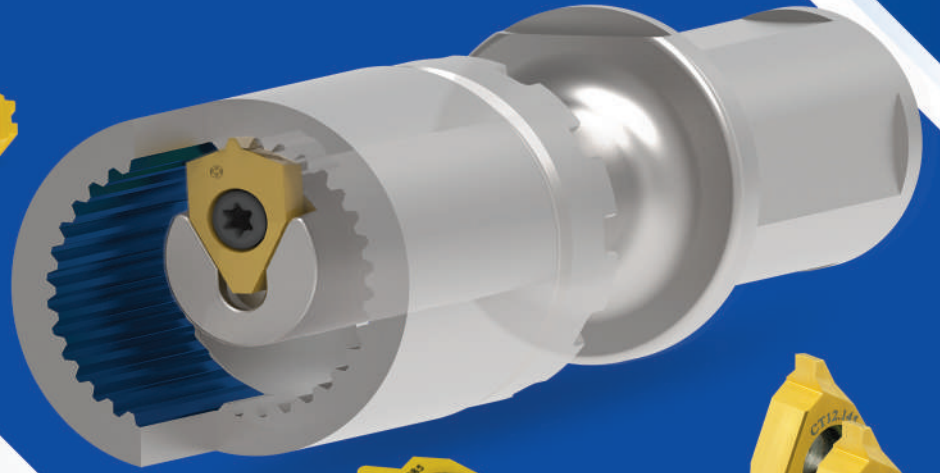

konusulan
the spoken kalite...
quality...

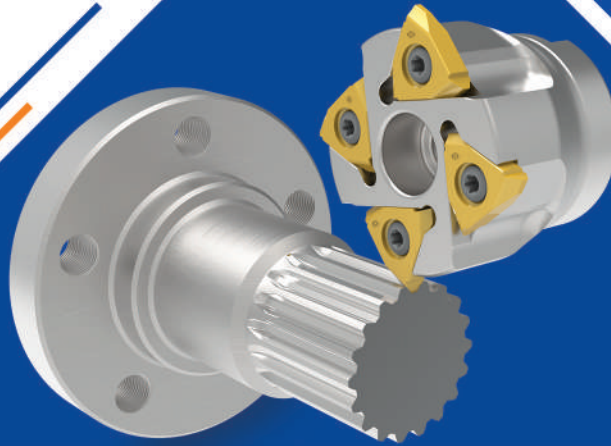

U-DRILL

TAKMA UÇLU MATKAPLAR
U-DRILL SYSTEM
VOLLBOHRER





AKKO **A** **TUM** **16** x **D3**

S **P** **G** **T** **06** **02** **04**

2 Kesici Stili / Cutter Style / Werkzeugtyp

3 Takım Çapı / Tool Diameter / Werkzeugdurchmesser

4 Delme Derinliği / Drilling Depth / Bohrtiefe

5 Uç Şekli / Insert Form / Plattenform

W **S**

8 Uç Tipi / Insert Type / Platten typ

$\beta = 70-90^\circ$ $\beta = 40-60^\circ$

10 Kalınlık / Thickness / Dicke

01 s = 1.59
T1 s = 1.98
02 s = 2.38
T2 s = 2.78
03 s = 3.18
T3 s = 3.97
04 s = 4.76
05 s = 5.56
06 s = 6.35
07 s = 7.94
09 s = 9.52

6 Serbest Uç Açısı / Clearance angle of Insert / Freiwinkel der Wendeschneidplatte

C **P**

7 Toleranslar / Tolerance Classes / Toleranzen

	A	± 0.025	± 0.005
	C	± 0.025	± 0.013
	E	± 0.025	± 0.025
	F	± 0.013	± 0.005
	G	± 0.025	± 0.025
	H	± 0.013	± 0.013
	J	± 0.05-0.15	± 0.005
	K	± 0.05-0.15	± 0.013
	L	± 0.05-0.15	± 0.025
	M	± 0.05-0.15	± 0.08-0.20
	N	± 0.05-0.15	± 0.08-0.20
	U	± 0.08-0.25	± 0.13-0.38

IC : Daire Ölçüsü / Inscribed Circle / Kreisgröße
M : Şekle Göre / Refer to Figure / Siehe Abbildung
S : Kalınlık / Thickness / Dicke

9 Kesme Kenar Uzunluğu / Cutting Edge Length / Schneidkantenlänge

11 Köşe Konfigurasyonu / Corner Radius / Eckenradius

01 r = 0.1
02 r = 0.2
04 r = 0.4
08 r = 0.8
12 r = 1.2
16 r = 1.6
24 r = 2.4

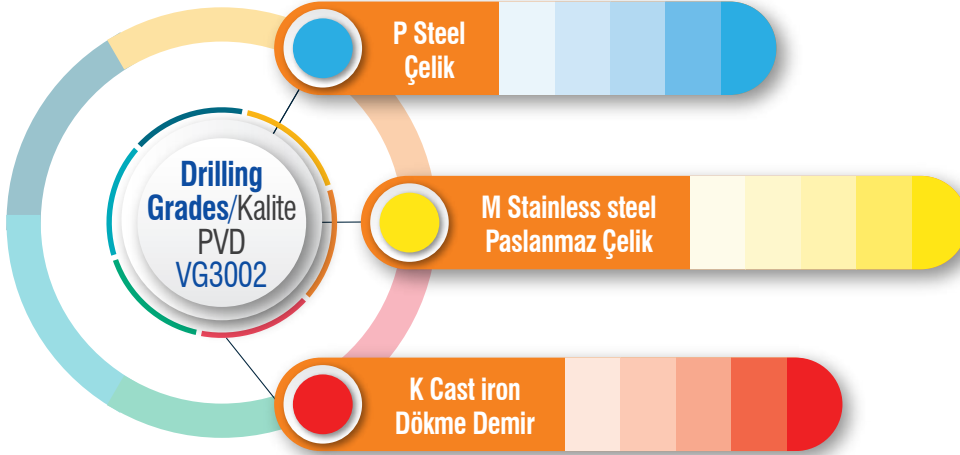

4 Corner / 4 Köşeli
SPMX Series / Serileri
00, 01, 02, 03, 04, 05



ISO 3 Corner / 3 Köşeli
WCMX Series / Serileri
00, 01, 02, 03, 04, 05

Grade Information / Kalite Bilgileri

PVD - TiAIN

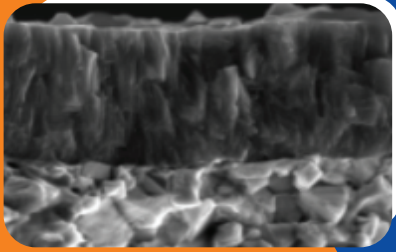

Universal grade for General Drilling Application

- Ultra Dense PVD Coating with optimal thermal resistance & strength
- Sub-Micron substrate designed for demanding application

Genel Delme Uygulaması için evrensel kalite

- Optimum termal direnç ve güce sahip Ultra Yoğun PVD Kaplama
- Zorlu uygulama için tasarlanmış alt Mikron tabaka

METRIC		DRILLING	
		Vc (m/min) VG3002	
ISO	SUB GROUP / ALT GRUP	MIN	MAX
P	Non Alloy Steel / Alaşimsız Çelik	180	280
	Low Alloy Steel / Düşük Alaşım Çelik	150	250
	High Alloy Steel / Yüksek Alaşım Çelik	70	140
M	Ferritic & Martensitic / Ferritik Ve Martenzitik	120	200
	Austenitic Stainless Steel / Östenitik Paslanmaz Çelik	130	250
	Grey Cast Iron / Gri Dökme Demir	120	250
	Nodular Cast Iron / Sferö Döküm Demir	130	220
N	Aluminum / Alüminyum	-	-
S	Titanium & Super Alloy / Titanyum Ve Süper Alaşım	25	45
H	Hardened Material / Sertleştirilmiş Malzeme	-	-



P20 – P35

M20 – M40

K20 – K40

S15 – S25



Drilling Chipbreakers / Talaş Kırıcı Formlar



-ST



- Sharp Geometry / Keskin Geometri
- Sticky Material, Stainless Steel
Yapışkan Malzeme, Paslanmaz Çelik

General Inserts
Genel Uçlar



- First Choice for General Application
Genel Uygulama İçin İlk Tercih

INCH		DRILLING Vc (m/min) VG3002	
ISO	SUB GROUP / ALT GRUP	MIN	MAX
P	Non Alloy Steel / Alaşımız Çelik	591	919
	Low Alloy Steel / Düşük Alaşımli Çelik	492	820
	High Alloy Steel / Yüksek Alaşımli Çelik	230	459
M	Ferritic & Martensitic / Ferritik Ve Martenzitik	394	656
	Austenitic Stainless Steel / Östenitik Paslanmaz Çelik	427	820
K	Grey Cast Iron / Gri Dökme Demir	394	820
	Nodular Cast Iron / Sferö Döküm Demir	427	711
N	Aluminum / Alüminyum	-	-
S	Titanium & Super Alloy / Titanyum Ve Süper Alaşım	82	148
H	Hardened Material / Sertleştirilmiş Malzeme	-	-

Drilling Insert / Delik Delme Ucu (SPMX)

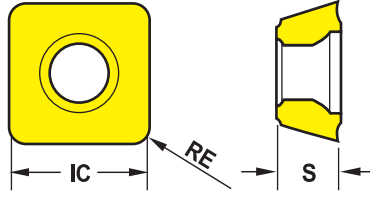

	IC	S
Metric	5	2.38
Inch	0.197	0.094
Metric	6	2.41
Inch	0.236	0.094
Metric	7.94	3.97
Inch	0.313	0.156
Metric	9.8	4.3
Inch	0.386	0.169
Metric	11.5	4.8
Inch	0.453	0.189
Metric	14.3	5.2
Inch	0.563	0.205

ISO 4 Corner
SPMX Series
00, 01, 02, 03, 04, 05



EDP	DESCRIPTION AÇIKLAMA	FEED RATE	İLERLEME
T.01.07.02.00	SPMX050204-VG3002	mm/rev. Inch/rev.	0.07~0.14 .003~.006
T.01.07.02.01	SPMX060204-VG3002	mm/rev. Inch/rev.	0.08~0.14 .003~.006
T.01.07.02.02	SPMX07T308-VG3002	mm/rev. Inch/rev.	0.08~0.16 .003~.006
T.01.07.02.03	SPMX090408-VG3002	mm/rev. Inch/rev.	0.08~0.16 .003~.006
T.01.07.02.04	SPMX110408-VG3002	mm/rev. Inch/rev.	0.10~0.18 .004~.007
T.01.07.02.05	SPMX140512-VG3002	mm/rev. Inch/rev.	0.10~0.20 .004~.008

Cutting Speed / Kesme Hızı			Vc (ft/min)	
ISO	VDI	Sub Group / Alt Grup	VG3002	
			Min	Max
P	1~5	Non-Alloyed Steel / Alaşimsız Çelik	460	1250
	6~9	Low-Alloyed Steel / Düşük Alaşımli Çelik	390	980
	10~11	High-Alloyed Steel / Yüksek Alaşımli Çelik	230	490
M	12~13	Ferritic & Martensitic / Ferritik Ve Martenzitik	390	660
	14	Austenitic Stainless Steel / Östenitik Paslanmaz Çelik	430	820
K	15~16	Grey Cast Iron / Gri Dökme Demir	390	820
	17~18	Nodular Cast Iron / Sferö Döküm Demir	430	720

Drilling Insert / Delik Delme Ucu (WCMX)

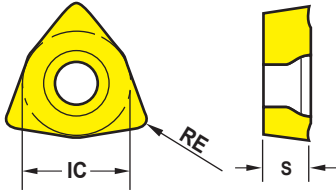

	IC	S
Metric	5.56	2.38
Inch	0.219	0.094
Metric	6.35	2.38
Inch	0.236	0.094
Metric	7.94	3.18
Inch	0.313	0.125
Metric	9.53	3.97
Inch	0.375	0.156
Metric	12.7	4.76
Inch	0.500	0.187



ISO 3 Corner
WCMX Series
01, 02, 03, 04, 05



EDP	DESCRIPTION AÇIKLAMA	FEED RATE	İLERLEME
T.01.07.01.01	WCMX030208-VG3002	mm/rev. Inch/rev.	0.05~0.12 .002~.005
T.01.07.01.02	WCMX040208-VG3002	mm/rev. Inch/rev.	0.05~0.12 .002~.005
T.01.07.01.03	WCMX050308-VG3002	mm/rev. Inch/rev.	0.06~0.14 .002~.006
T.01.07.01.04	WCMX06T308-VG3002	mm/rev. Inch/rev.	0.08~0.14 .003~.006
T.01.07.01.05	WCMX080412-VG3002	mm/rev. Inch/rev.	0.08~0.14 .003~.006

ISO	VDI	Sub Group / Alt Grup	Cutting Speed / Kesme Hızı	
			Vc (ft/min)	
			Min	Max
P	1~5	Non-Alloyed Steel / Alaşimsız Çelik	460	1250
	6~9	Low-Alloyed Steel / Düşük Alaşımli Çelik	390	980
	10~11	High-Alloyed Steel / Yüksek Alaşımli Çelik	230	490
M	12~13	Ferritic & Martensitic / Ferritik Ve Martenzitik	390	660
	14	Austenitic Stainless Steel / Östenitik Paslanmaz Çelik	430	820
K	15~16	Grey Cast Iron / Gri Dökme Demir	390	820
	17~18	Nodular Cast Iron / Sferö Döküm Demir	430	720



Delme Derinliği
Drilling Depth
Bohrtiefe

= 2x Çap
= 2x Diameter
= 2x Durchmesser

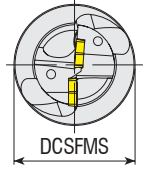
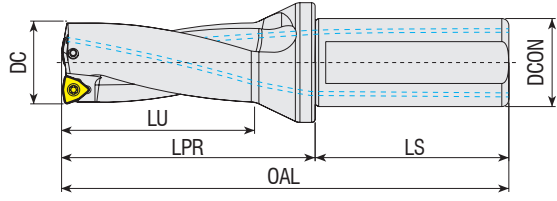

Takım Kodu Ordering Code Bestell-Bezeichnung	Stok Stock Lager	Takım Ölçüleri (mm) Dimension (mm) Abmessung (mm)							Maks. Ofset (radyal) Max. Offset (radial) Max. Versatz (radial)		Kesici Uç Insert Wendeschneidplatte	Yedek Parçaları / Spare Parts / Ersatzteile	
		DC	DCON	DCSFMS	OAL	LU	LPR	LS	X _{max} [mm]	DC _{max} [mm]		Sıkma Vidası Screw Schraube	Tork Anahtar Torx Key Torx-Schlüssel
ATUM 16XD2 WCM. 030208	●	16	25	34	110	32	54	56	1.5	19	WCM. 030208	3008-M2.5x6	82-T08
ATUM 16.5XD2 WCM. 030208	●	16.5	25	34	110	32	54	56	1.5	19.5			
ATUM 17XD2 WCM. 030208	●	17	25	34	112	34	56	56	1.5	20			
ATUM 17.5XD2 WCM. 030208	●	17.5	25	34	112	34	56	56	1.5	20.5			
ATUM 18XD2 WCM. 030208	●	18	25	34	114	36	58	56	1.4	20.8			
ATUM 18.5XD2 WCM. 030208	●	18.5	25	34	114	36	58	56	1.3	21.1			
ATUM 19XD2 WCM. 030208	●	19	25	34	116	38	60	56	1.2	21.4			
ATUM 19.5XD2 WCM. 030208	●	19.5	25	34	116	38	60	56	1.2	21.9			
ATUM 20XD2 WCM. 040208	●	20	25	34	118	40	62	56	1.5	23	WCM. 040208	3008-M2.5x6	82-T08
ATUM 20.5XD2 WCM. 040208	●	20.5	25	34	118	40	62	56	1.5	23.5			
ATUM 21XD2 WCM. 040208	●	21	25	34	120	42	64	56	1	23			
ATUM 21.5XD2 WCM. 040208	●	21.5	25	34	120	42	64	56	1	23.5			
ATUM 22XD2 WCM. 040208	●	22	25	34	122	44	66	56	1	24			
ATUM 22.5XD2 WCM. 040208	●	22.5	25	34	122	44	66	56	1	24.5			
ATUM 23XD2 WCM. 040208	●	23	25	34	124	46	68	56	1	25			
ATUM 23.5XD2 WCM. 040208	●	23.5	25	34	124	46	68	56	1	25.5			
ATUM 24XD2 WCM. 050308	●	24	25	34	126	48	70	56	1.4	26.8	WCM. 050308	3008-M3x8	82-T08
ATUM 24.5XD2 WCM. 050308	●	24.5	25	34	126	48	70	56	1.4	27.3			
ATUM 25XD2 WCM. 050308	●	25	25	34	128	50	72	56	1.45	27.9			
ATUM 25.5XD2 WCM. 050308	●	25.5	25	34	128	50	72	56	1.45	28.4			
ATUM 26XD2 WCM. 050308	●	26	25	34	130	52	74	56	1.45	28.9			
ATUM 26.5XD2 WCM. 050308	●	26.5	25	34	130	52	74	56	1.45	29.4			
ATUM 27XD2 WCM. 050308	●	27	25	34	132	54	76	56	1.45	29.9			
ATUM 27.5XD2 WCM. 050308	●	27.5	25	34	132	54	76	56	1.45	30.4			
ATUM 28XD2 WCM. 050308	●	28	25	34	134	56	78	56	1.6	31.2			
ATUM 28.5XD2 WCM. 050308	●	28.5	25	34	134	56	78	56	1.6	31.7			
ATUM 29XD2 WCM. 050308	●	29	25	34	136	58	80	56	1.65	32.3			
ATUM 29.5XD2 WCM. 050308	●	29.5	25	34	136	58	80	56	1.65	32.8			

R: Sağ / Right / Rechts/ L: Sol / Left / Links

● Stokta / In Stock / Auf Lager ○ Stokta Yok / Non Stock Item / Kein Lagerartikel, Lieferzeit auf Anfrage
ISO Ucuna Uygun / Compatible with ISO Insert. / Kompatibel mit ISO Wendeplatten.

Sipariş Örneği/Ordering Example/Bestellbeispiel

1 ad./pcs./stück ATUM 16XD2 WCM. 030208

Takma Uçlu Matkap Kullanım Kılavuzu : S 375 / User's Guide For U-Drills : P 375

Bedienungsanleitung für Vollbohrer : S 375



Delme Derinliği
Drilling Depth
Bohrtiefe

= 2x Çap
= 2x Diameter
= 2x Durchmesser

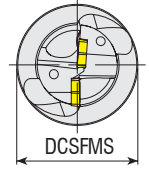
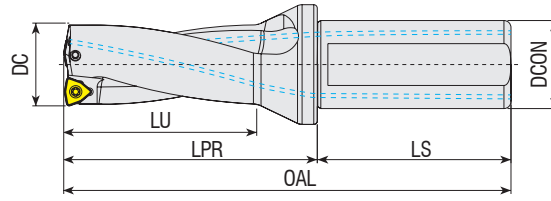

Takım Kodu
Ordering Code
Bestell-Bezeichnung

Stok
Stock
Lager

Takım Ölçüleri (mm)
Dimension (mm)
Abmessung (mm)

Maks. Ofset (radial)
Max. Offset (radial)
Max. Versatz (radial)

Kesici Uç
Insert
Wendescheidplatte

Yedek Parçaları / Spare Parts / Ersatzteile

Sıkma Vidası
Screw
Schraube

Tork Anahtar
Torx Key
Torx-Schlüssel

DC	DCON	DCSFMS	OAL	LU	LPR	LS	X _{max} [mm]	DC _{max} [mm]
----	------	--------	-----	----	-----	----	-----------------------	------------------------



ATUM 30XD2 WCM. 06T308	●	30	32	44	147	60	87	60	2.4	34.8	WCM. 06T308	3010-M3.5x9	82-T10
ATUM 31XD2 WCM. 06T308	●	31	32	44	149	62	89	60	2.3	35.6			
ATUM 32XD2 WCM. 06T308	●	32	32	44	151	64	91	60	2.1	36.2			
ATUM 33XD2 WCM. 06T308	●	33	32	44	153	66	93	60	1.9	36.8			
ATUM 34XD2 WCM. 06T308	●	34	32	44	155	68	95	60	1.9	37.8			
ATUM 35XD2 WCM. 06T308	●	35	32	44	157	70	97	60	1.9	38.8			
ATUM 36XD2 WCM. 06T308	●	36	32	44	159	72	99	60	2	40			
ATUM 37XD2 WCM. 06T308	●	37	32	44	161	74	101	60	1.8	40.6			
ATUM 38XD2 WCM. 06T308	●	38	32	44	163	76	103	60	1.5	41			
ATUM 39XD2 WCM. 06T308	●	39	32	44	165	78	105	60	1.3	41.6			
ATUM 40XD2 WCM. 06T308	●	40	32	44	167	80	107	60	1	42			
ATUM 41XD2 WCM. 06T308	●	41	32	44	169	82	109	60	0.8	42.6			
ATUM 42XD2 WCM. 06T308	●	42	32	44	171	84	111	60	0.5	43			
ATUM 43XD2 WCM. 06T308	●	43	32	44	173	86	113	60	0.3	43.6			
ATUM 44XD2 WCM. 06T308	●	44	32	44	175	88	115	60	0	44			
ATUM 45XD2 WCM. 080412	●	45	40	54	192	90	122	70	3.3	51.6	WCM. 080412	4015-M4x11	80-T15
ATUM 46XD2 WCM. 080412	●	46	40	54	194	92	124	70	3	52			
ATUM 47XD2 WCM. 080412	●	47	40	54	196	94	126	70	2.8	52.6			
ATUM 48XD2 WCM. 080412	●	48	40	54	198	96	128	70	2.5	53			
ATUM 49XD2 WCM. 080412	●	49	40	54	200	98	130	70	2.2	53.4			
ATUM 50XD2 WCM. 080412	●	50	40	54	202	100	132	70	2	54			
ATUM 51XD2 WCM. 080412	●	51	40	54	204	102	134	70	1.8	54.6			
ATUM 52XD2 WCM. 080412	●	52	40	54	206	104	136	70	1.5	55			
ATUM 53XD2 WCM. 080412	●	53	40	54	208	106	138	70	1.3	55.6			
ATUM 54XD2 WCM. 080412	●	54	40	54	210	108	140	70	1	56			
ATUM 55XD2 WCM. 080412	●	55	40	54	212	110	142	70	0.8	56.6			
ATUM 56XD2 WCM. 080412	●	56	40	64	214	112	144	70	0.5	57			
ATUM 57XD2 WCM. 080412	●	57	40	64	216	114	146	70	0.3	57.6			
ATUM 58XD2 WCM. 080412	●	58	40	64	218	116	148	70	0	58			
ATUM 59XD2 WCM. 080412	●	59	40	64	220	118	150	70	0	59			
ATUM 60XD2 WCM. 080412	●	60	40	64	222	120	152	70	0	60			

R: Sağ / Right / Rechts/ L: Sol / Left / Links

● Stokta / In Stock / Auf Lager ○ Stokta Yok / Non Stock Item / Kein Lagerartikel, Lieferzeit auf Anfrage

ISO Ucuna Uygunudur. / Compatible with ISO Insert. / Kompatibel mit ISO Wendeplatten.

Takma Uçlu Matkap Kullanım Kılavuzu : S 375 / User's Guide For U-Drills : P 375 / Bedienungsanleitung für Vollbohrer : S 375

Sipariş Örneği/Ordering Example/Bestellbeispiel

1 ad./pcs./stück ATUM 30XD2 WCM. 06T308



Delme Derinliği
Drilling Depth
Bohrtiefe

= 3x Çap
= 3x Diameter
= 3x Durchmesser

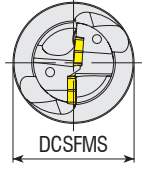
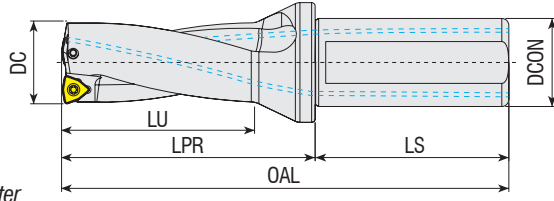

Takım Kodu Ordering Code Bestell-Bezeichnung	Stok Stock Lager	Takım Ölçüleri (mm) Dimension (mm) Abmessung (mm)							Maks. Ofset (radyal) Max. Ofset (radial) Max. Versatz (radial)		Kesici Uç Insert Wendeschneidplatte	Yedek Parçaları / Spare Parts / Ersatzteile	
		DC	DCON	DCSFMS	OAL	LU	LPR	LS	X _{max}	DC _{max} [mm]		Sıkma Vidası Screw Schraube	Tork Anahtar Torx Key Torx-Schlüssel
ATUM 16XD3 WCM. 030208	●	16	25	34	126	48	70	56	1.5	19	WCM. 030208	3008-M2.5x6	82-T08
ATUM 16.5XD3 WCM. 030208	●	16.5	25	34	126	48	70	56	1.5	19.5			
ATUM 17XD3 WCM. 030208	●	17	25	34	129	51	73	56	1.5	20			
ATUM 17.5XD3 WCM. 030208	●	17.5	25	34	129	51	73	56	1.5	20.5			
ATUM 18XD3 WCM. 030208	●	18	25	34	132	54	76	56	1.4	20.8			
ATUM 18.5XD3 WCM. 030208	●	18.5	25	34	132	54	76	56	1.3	21.1			
ATUM 19XD3 WCM. 030208	●	19	25	34	135	57	79	56	1.2	21.4			
ATUM 19.5XD3 WCM. 030208	●	19.5	25	34	135	57	79	56	1.2	21.9			
ATUM 20XD3 WCM. 040208	●	20	25	34	138	60	82	56	1.5	23	WCM. 040208	3008-M2.5x6	82-T08
ATUM 20.5XD3 WCM. 040208	●	20.5	25	34	138	60	82	56	1.5	23.5			
ATUM 21XD3 WCM. 040208	●	21	25	34	141	63	85	56	1	23			
ATUM 21.5XD3 WCM. 040208	●	21.5	25	34	141	63	85	56	1	23.5			
ATUM 22XD3 WCM. 040208	●	22	25	34	144	66	88	56	1	24			
ATUM 22.5XD3 WCM. 040208	●	22.5	25	34	144	66	88	56	1	24.5			
ATUM 23XD3 WCM. 040208	●	23	25	34	147	69	91	56	1	25			
ATUM 23.5XD3 WCM. 040208	●	23.5	25	34	147	69	91	56	1	25.5			
ATUM 24XD3 WCM. 050308	●	24	25	34	150	72	94	56	1.4	26.8	WCM. 050308	3008-M3x8	82-T08
ATUM 24.5XD3 WCM. 050308	●	24.5	25	34	150	72	94	56	1.4	27.3			
ATUM 25XD3 WCM. 050308	●	25	25	34	153	75	97	56	1.45	27.9			
ATUM 25.5XD3 WCM. 050308	●	25.5	25	34	153	75	97	56	1.45	28.4			
ATUM 26XD3 WCM. 050308	●	26	25	34	156	78	100	56	1.45	28.9			
ATUM 26.5XD3 WCM. 050308	●	26.5	25	34	156	78	100	56	1.45	29.4			
ATUM 27XD3 WCM. 050308	●	27	25	34	159	81	103	56	1.45	29.9			
ATUM 27.5XD3 WCM. 050308	●	27.5	25	34	159	81	103	56	1.45	30.4			
ATUM 28XD3 WCM. 050308	●	28	25	34	162	84	106	56	1.6	31.2			
ATUM 28.5XD3 WCM. 050308	●	28.5	25	34	162	84	106	56	1.6	31.7			
ATUM 29XD3 WCM. 050308	●	29	25	34	165	87	109	56	1.65	32.3			
ATUM 29.5XD3 WCM. 050308	●	29.5	25	34	165	87	109	56	1.65	32.8			
ATUM 30XD3 WCM. 06T308	●	30	32	44	177	90	117	60	2.4	34.8	WCM. 06T308	3010-M3.5x9	82-T10
ATUM 30.5XD3 WCM. 06T308	●	30.5	32	44	177	90	117	60	2.4	35.3			
ATUM 31XD3 WCM. 06T308	●	31	32	44	180	93	120	60	2.3	35.6			
ATUM 31.5XD3 WCM. 06T308	●	31.5	32	44	180	93	120	60	2.3	36.1			
ATUM 32XD3 WCM. 06T308	●	32	32	44	183	96	123	60	2.1	36.2			
ATUM 32.5XD3 WCM. 06T308	●	32.5	32	44	183	96	123	60	2.1	36.7			
ATUM 33XD3 WCM. 06T308	●	33	32	44	186	99	126	60	1.9	36.8			
ATUM 33.5XD3 WCM. 06T308	●	33.5	32	44	186	99	126	60	1.9	37.3			
ATUM 34XD3 WCM. 06T308	●	34	32	44	189	102	129	60	1.9	37.8			
ATUM 34.5XD3 WCM. 06T308	●	34.5	32	44	189	102	129	60	1.9	38.3			

R: Sağ / Right / Rechts/ L: Sol / Left / Links

● Stokta / In Stock / Auf Lager ○ Stokta Yok / Non Stock Item / Kein Lagerartikel, Lieferzeit auf Anfrage
ISO Uçuna Uygundur. / Compatible with ISO Insert. / Kompatibel mit ISO Wendeplatten.

Sipariş Örneği/Ordering Example/Bestellbeispiel
1 ad./pcs./stück ATUM 16XD3 WCM. 030208

Takma Uçlu Matkap Kullanım Kılavuzu : S 375 / User's Guide For U-Drills : P 375
Bedienungsanleitung für Vollbohrer : S 375



Delme Derinliği
Drilling Depth
Bohrtiefe

= 3x Çap
= 3x Diameter
= 3x Durchmesser

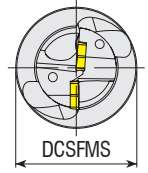
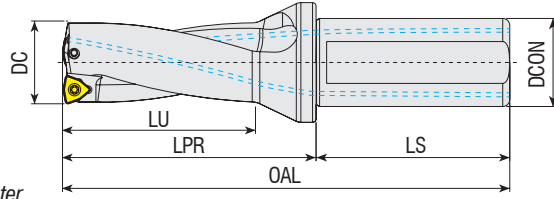

Takım Kodu
Ordering Code
Bestell-Bezeichnung

Stok
Stock
Lager

Takım Ölçüleri (mm)
Dimension (mm)
Abmessung (mm)

Maks. Ofset (radyal)
Max. Offset (radial)
Max. Versatz (radial)

Kesici Uç
Insert
Wendeschneidplatte

Yedek Parçaları / Spare Parts / Ersatzteile

Sıkma Vidası
Screw
Schraube

Tork Anahtar
Torx Key
Torx-Schlüssel

DC	DCON	DCSFMS	OAL	LU	LPR	LS	X _{max} [mm]	DC _{max} [mm]
----	------	--------	-----	----	-----	----	-----------------------	------------------------

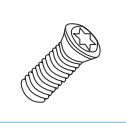

ATUM 35XD3 WCM. 06T308	●	35	32	44	192	105	132	60	1.9	38.8
ATUM 35.5XD3 WCM. 06T308	●	35.5	32	44	192	105	132	60	1.9	39.3
ATUM 36XD3 WCM. 06T308	●	36	32	44	195	108	135	60	2	40
ATUM 36.5XD3 WCM. 06T308	●	36.5	32	44	195	108	135	60	2	40.5
ATUM 37XD3 WCM. 06T308	●	37	32	44	198	111	138	60	1.8	40.6
ATUM 37.5XD3 WCM. 06T308	●	37.5	32	44	198	111	138	60	1.8	41.1
ATUM 38XD3 WCM. 06T308	●	38	32	44	201	114	141	60	1.5	41
ATUM 38.5XD3 WCM. 06T308	●	38.5	32	44	201	114	141	60	1.5	41.5
ATUM 39XD3 WCM. 06T308	●	39	32	44	204	117	144	60	1.3	41.6
ATUM 39.5XD3 WCM. 06T308	●	39.5	32	44	204	117	144	60	1.3	42.1
ATUM 40XD3 WCM. 06T308	●	40	32	44	207	120	147	60	1	42
ATUM 40.5XD3 WCM. 06T308	●	40.5	32	44	207	120	147	60	1	42.5
ATUM 41XD3 WCM. 06T308	●	41	32	44	210	123	150	60	0.8	42.6
ATUM 41.5XD3 WCM. 06T308	●	41.5	32	44	210	123	150	60	0.8	43.1
ATUM 42XD3 WCM. 06T308	●	42	32	44	213	126	153	60	0.5	43
ATUM 42.5XD3 WCM. 06T308	●	42.5	32	44	213	126	153	60	0.5	43.5
ATUM 43XD3 WCM. 06T308	●	43	32	44	216	129	156	60	0.3	43.6
ATUM 43.5XD3 WCM. 06T308	●	43.5	32	44	216	129	156	60	0.3	44.1
ATUM 44XD3 WCM. 06T308	●	44	32	44	219	132	159	60	0	44
ATUM 44.5XD3 WCM. 06T308	●	44.5	32	44	219	132	159	60	0	44.5
ATUM 45XD3 WCM. 080412	●	45	40	54	237	135	167	70	3.3	51.6
ATUM 45.5XD3 WCM. 080412	●	45.5	40	54	237	135	167	70	3.3	52.1
ATUM 46XD3 WCM. 080412	●	46	40	54	240	138	170	70	3	52
ATUM 47XD3 WCM. 080412	●	47	40	54	243	141	173	70	2.8	52.6
ATUM 48XD3 WCM. 080412	●	48	40	54	246	144	176	70	2.5	53
ATUM 49XD3 WCM. 080412	●	49	40	54	249	147	179	70	2.2	53.4
ATUM 50XD3 WCM. 080412	●	50	40	54	252	150	182	70	2	54
ATUM 51XD3 WCM. 080412	●	51	40	54	255	153	185	70	1.8	54.6
ATUM 52XD3 WCM. 080412	●	52	40	54	258	156	188	70	1.5	55
ATUM 53XD3 WCM. 080412	●	53	40	54	261	159	191	70	1.3	55.6
ATUM 54XD3 WCM. 080412	●	54	40	54	264	162	194	70	1	56
ATUM 55XD3 WCM. 080412	●	55	40	54	267	165	197	70	0.8	56.6
ATUM 56XD3 WCM. 080412	●	56	40	64	270	168	200	70	0.5	57
ATUM 57XD3 WCM. 080412	●	57	40	64	273	171	203	70	0.3	57.6
ATUM 58XD3 WCM. 080412	●	58	40	64	276	174	206	70	0	58
ATUM 59XD3 WCM. 080412	●	59	40	64	279	177	209	70	0	59
ATUM 60XD3 WCM. 080412	●	60	40	64	282	180	212	70	0	60

WCM. 06T308

3010-M3.5x9

82-T10

WCM. 080412

4015-M4x11

80-T15

R: Sağ / Right / Rechts! L: Sol / Left / Links

● Stokta / In Stock / Auf Lager ○ Stokta Yok / Non Stock Item / Kein Lagerartikel, Lieferzeit auf Anfrage
ISO Ucuna Uygunudur. / Compatible with ISO Insert. / Kompatibel mit ISO Wendeplatten.

Sipariş Örneği/Ordering Example/Bestellbeispiel
1 ad./pcs./stück ATUM 35XD3 WCM. 06T308

Takma Uçlu Matkap Kullanım Kılavuzu : S 375 / User's Guide For U-Drills : P 375
Bedienungsanleitung für Vollbohrer : S 375



Delme Derinliği
Drilling Depth
Bohrtiefe = 4x Çap
= 4x Diameter
= 4x Durchmesser

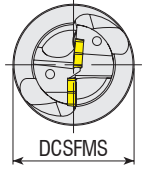
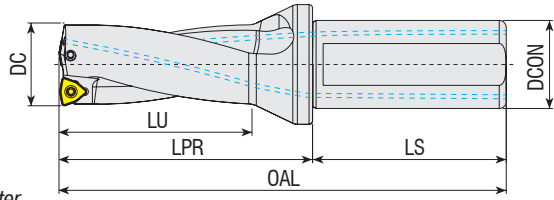

Takım Kodu Ordering Code Bestell-Bezeichnung	Stok Stock Lager	Takım Ölçüleri (mm) Dimension (mm) Abmessung (mm)							Maks. Ofset (radial) Max. Offset (radial) Max. Versatz (radial)		Kesici Uç Insert Wendeschneidplatte	Yedek Parçaları / Spare Parts / Ersatzteile	
		DC	DCON	DCSFMS	OAL	LU	LPR	LS	X _{max}	DC _{max} [mm]		Sıkma Vidası Screw Schraube	Tork Anahtar Torx Key Torx-Schlüssel
ATUM 16XD4 WCM. 030208	●	16	25	34	142	64	86	56	1.5	19	WCM. 030208		
ATUM 16.5XD4 WCM. 030208	○	16.5	25	34	142	64	86	56	1.5	19.5			
ATUM 17XD4 WCM. 030208	●	17	25	34	146	68	90	56	1.5	20			
ATUM 17.5XD4 WCM. 030208	●	17.5	25	34	146	68	90	56	1.5	20.5			
ATUM 18XD4 WCM. 030208	●	18	25	34	150	72	94	56	1.4	20.8			
ATUM 18.5XD4 WCM. 030208	○	18.5	25	34	150	72	94	56	1.3	21.1			
ATUM 19XD4 WCM. 030208	●	19	25	34	154	76	98	56	1.2	21.4			
ATUM 19.5XD4 WCM. 030208	○	19.5	25	34	154	76	98	56	1.2	21.9			
ATUM 20XD4 WCM. 040208	●	20	25	34	158	80	102	56	1.5	23	WCM. 040208	3008-M2.5x6	82-T08
ATUM 20.5XD4 WCM. 040208	○	20.5	25	34	158	80	102	56	1.5	23.5			
ATUM 21XD4 WCM. 040208	●	21	25	34	162	84	106	56	1	23			
ATUM 21.5XD4 WCM. 040208	○	21.5	25	34	162	84	106	56	1	23.5			
ATUM 22XD4 WCM. 040208	●	22	25	34	166	88	110	56	1	24			
ATUM 22.5XD4 WCM. 040208	●	22.5	25	34	166	88	110	56	1	24.5			
ATUM 23XD4 WCM. 040208	●	23	25	34	170	92	114	56	1	25			
ATUM 23.5XD4 WCM. 040208	○	23.5	25	34	170	92	114	56	1	25.5			
ATUM 24XD4 WCM. 050308	●	24	25	34	174	96	118	56	1.4	26.8	WCM. 050308	3008-M3x8	
ATUM 24.5XD4 WCM. 050308	○	24.5	25	34	174	96	118	56	1.4	27.3			
ATUM 25XD4 WCM. 050308	●	25	25	34	178	100	122	56	1.45	27.9			
ATUM 25.5XD4 WCM. 050308	○	25.5	25	34	178	100	122	56	1.45	28.4			
ATUM 26XD4 WCM. 050308	●	26	25	34	182	104	126	56	1.45	28.9			
ATUM 26.5XD4 WCM. 050308	●	26.5	25	34	182	104	126	56	1.45	29.4			
ATUM 27XD4 WCM. 050308	●	27	25	34	186	108	130	56	1.45	29.9			
ATUM 27.5XD4 WCM. 050308	○	27.5	25	34	186	108	130	56	1.45	30.4			
ATUM 28XD4 WCM. 050308	●	28	25	34	190	112	134	56	1.6	31.2			
ATUM 28.5XD4 WCM. 050308	●	28.5	25	34	190	112	134	56	1.6	31.7			
ATUM 29XD4 WCM. 050308	●	29	25	34	194	116	138	56	1.65	32.3			
ATUM 29.5XD4 WCM. 050308	○	29.5	25	34	194	116	138	56	1.65	32.8			

R: Sağ / Right / Rechts/ L: Sol / Left / Links

● Stokta / In Stock / Auf Lager ○ Stokta Yok / Non Stock Item / Kein Lagerartikel, Lieferzeit auf Anfrage
ISO Ucuna Uygundur. / Compatible with ISO Insert. / Kompatibel mit ISO Wendeschneidplatten.

Sipariş Örneği/Ordering Example/Bestellbeispiel

1 ad./pcs./stück ATUM 16XD4 WCM. 030208

Takma Uçlu Matkap Kullanım Kılavuzu : S 375 / User's Guide For U-Drills : P 375

Bedienungsanleitung für Vollbohrer : S 375



Delme Derinliği
Drilling Depth
Bohrtiefe

= 4x Çap
= 4x Diameter
= 4x Durchmesser

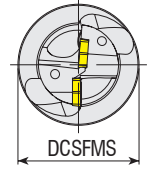
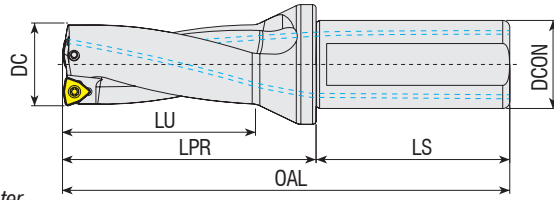

Takım Kodu
Ordering Code
Bestell-Bezeichnung

Stok
Stock
Lager

Takım Ölçüleri (mm)
Dimension (mm)
Abmessung (mm)

Maks. Ofset (radyal)
Max. Offset (radial)
Max. Versatz (radial)

Kesici Uç
Insert
Wendeschnidplatte

Yedek Parçaları / Spare Parts / Ersatzteile

Sıkma Vidası
Screw
Schraube

Tork Anahtar
Torx Key
Torx-Schlüssel

DC

DCON

DCSFMS

OAL

LU

LPR

LS

X_{max}

DC_{max}



Takım Kodu Ordering Code Bestell-Bezeichnung	Stok Stock Lager	DC	DCON	DCSFMS	OAL	LU	LPR	LS	X _{max}	DC _{max}	Kesici Uç Insert Wendeschnidplatte	Sıkma Vidası Screw Schraube	Tork Anahtar Torx Key Torx-Schlüssel
ATUM 30XD4 WCM. 06T308	●	30	32	44	207	120	147	60	2.4	34.8	WCM. 06T308	3010-M3.5x9	82-T10
ATUM 31XD4 WCM. 06T308	●	31	32	44	211	124	151	60	2.3	35.6			
ATUM 32XD4 WCM. 06T308	●	32	32	44	215	128	155	60	2.1	36.2			
ATUM 33XD4 WCM. 06T308	●	33	32	44	219	132	159	60	1.9	36.8			
ATUM 33.5XD4 WCM. 06T308	●	33.5	32	44	219	132	159	60	1.9	37.3			
ATUM 34XD4 WCM. 06T308	●	34	32	44	223	136	163	60	1.9	37.8			
ATUM 35XD4 WCM. 06T308	●	35	32	44	227	140	167	60	1.9	38.8			
ATUM 36XD4 WCM. 06T308	●	36	32	44	231	144	171	60	2	40			
ATUM 37XD4 WCM. 06T308	●	37	32	44	235	148	175	60	1.8	40.6			
ATUM 38XD4 WCM. 06T308	●	38	32	44	239	152	179	60	1.5	41			
ATUM 38.5XD4 WCM. 06T308	●	38.5	32	44	239	152	179	60	1.5	41.5			
ATUM 39XD4 WCM. 06T308	●	39	32	44	243	156	183	60	1.3	41.6			
ATUM 40XD4 WCM. 06T308	●	40	32	44	247	160	187	60	1	42			
ATUM 41XD4 WCM. 06T308	●	41	32	44	251	164	191	60	0.8	42.6			
ATUM 42XD4 WCM. 06T308	●	42	32	44	255	168	195	60	0.5	43			
ATUM 43XD4 WCM. 06T308	●	43	32	44	259	172	199	60	0.3	43.6			
ATUM 44XD4 WCM. 06T308	●	44	32	44	263	176	203	60	0	44			
ATUM 45XD4 WCM. 080412	●	45	40	54	282	180	212	70	3.3	51.6	WCM. 080412	4015-M4x11	80-T15
ATUM 46XD4 WCM. 080412	●	46	40	54	286	184	216	70	3	52			
ATUM 47XD4 WCM. 080412	●	47	40	54	290	188	220	70	2.8	52.6			
ATUM 48XD4 WCM. 080412	●	48	40	54	294	192	224	70	2.5	53			
ATUM 49XD4 WCM. 080412	●	49	40	54	298	196	228	70	2.2	53.4			
ATUM 50XD4 WCM. 080412	●	50	40	54	302	200	232	70	2	54			

R: Sağ / Right / Rechts L: Sol / Left / Links

● Stokta / In Stock / Auf Lager ○ Stokta Yok / Non Stock Item / Kein Lagerartikel, Lieferzeit auf Anfrage
ISO Ucuna Uygunudur. / Compatible with ISO Insert. / Kompatibel mit ISO Wendeplatten.

Sipariş Örneği/Ordering Example/Bestellbeispiel

1 ad./pcs./stück ATUM 30XD4 WCM. 06T308



Takma Uçlu Matkap Kullanım Kılavuzu : S 375 / User's Guide For U-Drills : P 375

Bedienungsanleitung für Vollbohrer : S 375

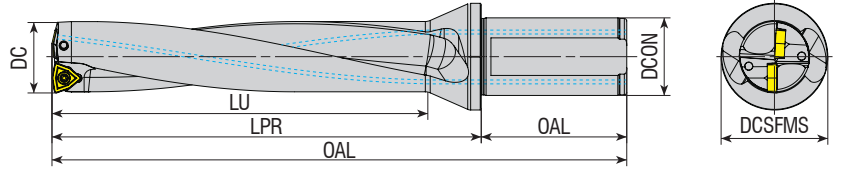



Delme Derinliği = 5x Çap
Drilling Depth = 5x Diameter
Bohrtiefe = 5x Durchmesser

Takım Kodu Ordering Code Bestell-Bezeichnung	Stok Stock Lager								Maks. Ofset (radyal) Max. Offset (radial) Max. Versatz (radial)	X _{max} [mm]	DC _{max} [mm]			
ATUM 20XD5 WCM. 040208	●	20	25	34	178	100	122	56			WCM. 040208	3008-M2.5x6	82-T08	
ATUM 21XD5 WCM. 040208	●	21	25	34	183	105	127	56						
ATUM 22XD5 WCM. 040208	●	22	25	34	188	110	132	56						
ATUM 23XD5 WCM. 040208	●	23	25	34	193	115	137	56						
ATUM 24XD5 WCM. 050308	●	24	25	34	198	120	142	56			WCM. 050308	3008-M3x8	82-T08	
ATUM 25XD5 WCM. 050308	●	25	25	34	203	125	147	56						
ATUM 26XD5 WCM. 050308	●	26	25	34	208	130	152	56						
ATUM 27XD5 WCM. 050308	●	27	25	34	213	135	157	56						
ATUM 28XD5 WCM. 050308	●	28	25	34	218	140	162	56						
ATUM 29XD5 WCM. 050308	●	29	25	34	223	145	167	56						
ATUM 30XD5 WCM. 06T308	●	30	32	44	237	150	177	60			WCM. 06T308	3010-M3.5x9	82-T10	
ATUM 31XD5 WCM. 06T308	●	31	32	44	242	155	182	60						
ATUM 32XD5 WCM. 06T308	●	32	32	44	247	160	187	60						
ATUM 33XD5 WCM. 06T308	●	33	32	44	252	165	192	60						
ATUM 34XD5 WCM. 06T308	●	34	32	44	257	170	197	60						
ATUM 35XD5 WCM. 06T308	●	35	32	44	262	175	202	60						
ATUM 37XD5 WCM. 06T308	●	37	32	44	272	185	212	60						
ATUM 38XD5 WCM. 06T308	●	38	32	44	277	190	217	60						
ATUM 46XD5 WCM. 080412	●	46	40	54	332	230	262	70			WCM. 080412	4015-M4x11	80-T15	

R: Sağ / Right / Rechts/ L: Sol / Left / Links

● Stokta / In Stock / Auf Lager ○ Stokta Yok / Non Stock Item / Kein Lagerartikel, Lieferzeit auf Anfrage

ISO Ucuna Uygundur. / Compatible with ISO Insert. / Kompatibel mit ISO Wendeplatten.



www.akkо.com.tr

Sipariş Örneği/Ordering Example/Bestellbeispiel

1 ad./pcs./stück ATUM 20XD5 WCM. 040208

Takma Uçlu Matkap Kullanım Kılavuzu : S 375 / User's Guide For U-Drills : P 375

Bedienungsanleitung für Vollbohrer : S 375



Delme Derinliği
Drilling Depth
Bohrtiefe
= 2x Çap
= 2x Diameter
= 2x Durchmesser

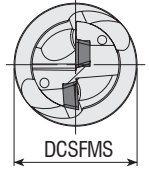
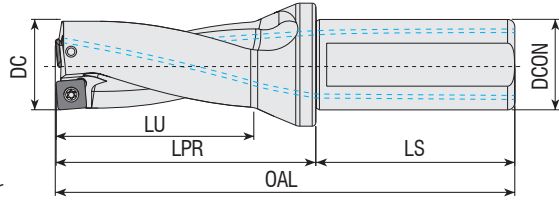

Takım Kodu Ordering Code Bestell-Bezeichnung	Stok Stock Lager	Takım Ölçüleri (mm) Dimension (mm) Abmessung (mm)								Maks. Ofset (radial) Max. Offset (radial) Max. Versatz (radial)	Kesici Uç Insert Wendeschneidplatte	Yedek Parçaları / Spare Parts / Ersatzteile	
		DC	DCON	DCSFMS	OAL	LU	LPR	LS	Sıkma Vidası Screw Schraube			Tork Anahtar Torx Key Torx-Schlüssel	
ATUM 12.5XD2 SP. 050204	●	12.5	20	25	96	24	46	50	0.75	14	SP. 050204	3006-M2x4	82-T06
ATUM 13XD2 SP. 050204	●	13	20	25	98	26	48	50	0.75	14.5			
ATUM 13.5XD2 SP. 050204	●	13.5	20	25	98	26	48	50	0.75	15			
ATUM 14XD2 SP. 050204	●	14	20	25	100	28	50	50	0.6	15.2			
ATUM 14.5XD2 SP. 050204	●	14.5	20	25	100	28	50	50	0.6	15.7			
ATUM 15XD2 SP. 050204	●	15	20	25	102	30	52	50	0.5	16			
ATUM 15.5XD2 SP. 060204	●	15.5	20	25	102	30	52	50	0.9	17.3	SP. 060204	3007-M2.2x4.6	82-T07
ATUM 16XD2 SP. 060204	●	16	25	34	110	32	54	56	0.8	17.6			
ATUM 16.5XD2 SP. 060204	●	16.5	25	34	110	32	54	56	0.8	18.1			
ATUM 17XD2 SP. 060204	●	17	25	34	112	34	56	56	0.75	18.5			
ATUM 17.5XD2 SP. 060204	●	17.5	25	34	112	34	56	56	0.75	19			
ATUM 18XD2 SP. 060204	●	18	25	34	114	36	58	56	0.5	19			
ATUM 18.5XD2 SP. 060204	●	18.5	25	34	114	36	58	56	0.5	19.5			
ATUM 19XD2 SP. 060204	●	19	25	34	116	38	60	56	0.3	19.6			
ATUM 19.5XD2 SP. 060204	●	19.5	25	34	116	38	60	56	0.3	20.1			
ATUM 20XD2 SP. 060204	●	20	25	34	118	40	62	56	0	20			
ATUM 20.5XD2 SP. 060204	●	20.5	25	34	118	40	62	56	0	20.5			
ATUM 21XD2 SP. 060204	●	21	25	34	120	42	64	56	0	21			
ATUM 21.5XD2 SP. 060204	●	21.5	25	34	120	42	64	56	0	21.5			
ATUM 22XD2 SP. 07T308	●	22	25	34	122	44	66	56	1	24	SP. 07T308	3008-M2.5x6	82-T08
ATUM 22XD2 SP. 07T308-32	●	22	32	44	131	44	71	60	1	24			
ATUM 22.5XD2 SP. 07T308	●	22.5	25	34	122	44	66	56	1	24.5	SP. 07T308	3008-M2.5x6	82-T08
ATUM 23XD2 SP. 07T308	●	23	25	34	124	46	68	56	0.75	24.5			
ATUM 23XD2 SP. 07T308-32	●	23	32	44	133	46	73	60	0.75	24.5			
ATUM 23.5XD2 SP. 07T308	●	23.5	25	34	124	46	68	56	0.75	25			
ATUM 24XD2 SP. 07T308	●	24	25	34	126	48	70	56	0.5	25			
ATUM 24XD2 SP. 07T308-32	●	24	32	44	135	48	75	60	0.50	25			
ATUM 24.5XD2 SP. 07T308	●	24.5	25	34	126	48	70	56	0.5	25.5			
ATUM 25XD2 SP. 07T308	●	25	25	34	128	50	72	56	0.25	25.5			
ATUM 25XD2 SP. 07T308-32	●	25	32	44	137	50	77	60	0.25	25.5			
ATUM 25.5XD2 SP. 07T308	●	25.5	25	34	128	50	72	56	0.25	26			
ATUM 26XD2 SP. 07T308	●	26	25	34	130	52	74	56	0	26			
ATUM 26XD2 SP. 07T308-32	●	26	32	44	139	52	79	60	0	26			
ATUM 26.5XD2 SP. 07T308	●	26.5	25	34	130	52	74	56	0	26.5			
ATUM 27XD2 SP. 07T308	●	27	25	34	132	54	76	56	0	27			
ATUM 27XD2 SP. 07T308-32	●	27	32	44	141	54	81	60	0	27			
ATUM 27.5XD2 SP. 07T308	●	27.5	25	34	132	54	76	56	0	27.5			

R: Sağ / Right / Rechtsl L: Sol / Left / Links

● Stokta / In Stock / Auf Lager ○ Stokta Yok / Non Stock Item / Kein Lagerartikel, Lieferzeit auf Anfrage

TGTC Uçuna Uygundur. / Compatible with TGTC Insert. / Kompatibel mit TGTC Wendeplatten.

Sipariş Örneği/Ordering Example/Bestellbeispiel

1 ad./pcs./stück ATUM 12.5XD2 SP. 050204

Takma Uçlu Matkap Kullanım Kılavuzu : S 375 / User's Guide For U-Drills : P 375

Bedienungsanleitung für Vollbohrer : S 375



Delme Derinliği
Drilling Depth
Bohrtiefe

= 2x Çap
= 2x Diameter
= 2x Durchmesser

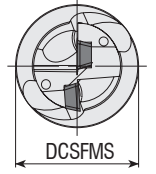
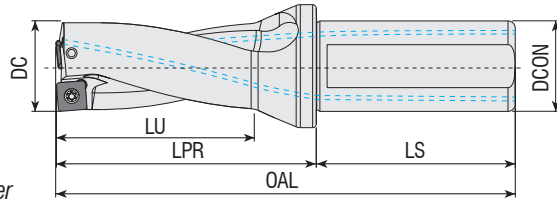

Takım Kodu Ordering Code Bestell-Bezeichnung	Stok Stock Lager	Takım Ölçüleri (mm) Dimension (mm) Abmessung (mm)								Maks. Ofset (radyal) Max. Offset (radial) Max. Versatz (radial)	Kesici Uç Insert Wendeschneidplatte	Yedek Parçaları / Spare Parts / Ersatzteile	
		DC	DCON	DCSFMS	OAL	LU	LPR	LS	Sıkma Vidası Screw Schraube			Tork Anahtar Torx Key Torx-Schlüssel	
ATUM 28XD2 SP. 090408	●	28	25	34	134	56	78	56	1	30	SP. 090408	4015-M3.5x9	80-T15
ATUM 28XD2 SP. 090408-32	●	28	32	44	143	56	83	60	1	29			
ATUM 28.5XD2 SP. 090408	●	28.5	25	34	134	56	78	56	1	30.5			
ATUM 29XD2 SP. 090408	●	29	25	34	136	58	80	56	0.75	30.5			
ATUM 29XD2 SP. 090408-32	●	29	32	44	145	58	85	60	0.75	30.5			
ATUM 29.5XD2 SP. 090408	●	29.5	25	34	136	58	80	56	0.75	31			
ATUM 30XD2 SP. 090408	●	30	32	44	147	60	87	60	0.5	31			
ATUM 31XD2 SP. 090408	●	31	32	44	149	62	89	60	0.25	31.5			
ATUM 32XD2 SP. 090408	●	32	32	44	151	64	91	60	0	32			
ATUM 33XD2 SP. 090408	●	33	32	44	153	66	93	60	0	33			
ATUM 34XD2 SP. 110408	●	34	32	44	155	68	95	60	1	36	SP. 110408	4015-M4x11	80-T15
ATUM 35XD2 SP. 110408	●	35	32	44	157	70	97	60	0.75	36.5			
ATUM 36XD2 SP. 110408	●	36	32	44	159	72	99	60	0.6	37.2			
ATUM 37XD2 SP. 110408	●	37	32	44	161	74	101	60	0.5	38			
ATUM 38XD2 SP. 110408	●	38	32	44	163	76	103	60	0.25	38.5			
ATUM 39XD2 SP. 110408	●	39	32	44	165	78	105	60	0	39			
ATUM 40XD2 SP. 110408	●	40	32	44	167	80	107	60	0	40			
ATUM 41XD2 SP. 110408	●	41	32	44	169	82	109	60	0	41			
ATUM 42XD2 SP. 140512	●	42	32	44	171	84	111	60	1.2	44.4	SP. 140512	1020-M5x11	80-T20
ATUM 43XD2 SP. 140512	●	43	32	44	173	86	113	60	1	45			
ATUM 44XD2 SP. 140512	●	44	32	44	175	88	115	60	0.8	45.6			
ATUM 45XD2 SP. 140512	●	45	40	54	192	90	122	70	0.6	46.2			
ATUM 46XD2 SP. 140512	●	46	40	54	194	92	124	70	0.4	46.8			
ATUM 47XD2 SP. 140512	●	47	40	54	196	94	126	70	0.2	47.4			
ATUM 48XD2 SP. 140512	●	48	40	54	198	96	128	70	0	48			
ATUM 49XD2 SP. 140512	●	49	40	54	200	98	130	70	0	49			
ATUM 50XD2 SP. 140512	●	50	40	54	202	100	132	70	0	50			

R: Sağ / Right / Rechts/ L: Sol / Left / Links

● Stokta / In Stock / Auf Lager ○ Stokta Yok / Non Stock Item / Kein Lagerartikel, Lieferzeit auf Anfrage
TGTC Ucuna Uygunudur. / Compatible with TGTC Insert. / Kompatibel mit TGTC Wendeplatten.

Sipariş Örneği/Ordering Example/Bestellbeispiel
1 ad./pcs./stück ATUM 28XD2 SP. 090408

Takma Uçlu Matkap Kullanım Kılavuzu : S 375 / User's Guide For U-Drills : P 375
Bedienungsanleitung für Vollbohrer : S 375



Delme Derinliği
Drilling Depth
Bohrtiefe

= 3x Çap
= 3x Diameter
= 3x Durchmesser

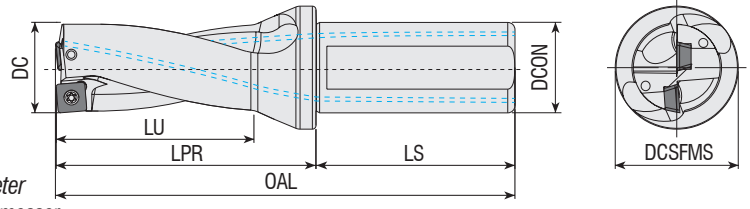

Takım Kodu
Ordering Code
Bestell-Bezeichnung

Stok
Stock
Lager

Takım Ölçüleri (mm)
Dimension (mm)
Abmessung (mm)

Maks. Ofset (radyal)
Max. Offset (radial)
Max. Versatz (radial)

Kesici Uç
Insert
Wendeschnidplatte

Yedek Parçaları / Spare Parts / Ersatzteile

Sıkma Vidası
Screw
Schraube

Tork Anahtar
Torx Key
Torx-Schlüssel

ATUM	Takım Kodu	SP.	SP.	Stok	DC	DCON	DCSFMS	OAL	LU	LPR	LS	Maks. Ofset	Kesici Uç	Sıkma Vidası	Tork Anahtar
ATUM 12.5XD3	SP. 050204	●	12.5	20	25	108	36	58	50	0.75	14	SP. 050204	3006-M2x4	82-T06	
ATUM 13XD3	SP. 050204	●	13	20	25	111	39	61	50	0.75	14.5				
ATUM 13.5XD3	SP. 050204	●	13.5	20	25	111	39	61	50	0.75	15				
ATUM 14XD3	SP. 050204	●	14	20	25	114	42	64	50	0.6	15.2				
ATUM 14.5XD3	SP. 050204	●	14.5	20	25	114	42	64	50	0.6	15.7				
ATUM 15XD3	SP. 050204	●	15	20	25	117	45	67	50	0.5	16	SP. 060204	3007-M2.2x4.6	82-T07	
ATUM 15.5XD3	SP. 060204	●	15.5	20	25	117	45	67	50	0.9	17.3				
ATUM 16XD3	SP. 060204	●	16	25	34	126	48	70	56	0.8	17.6				
ATUM 16.5XD3	SP. 060204	●	16.5	25	34	126	48	70	56	0.8	18.1				
ATUM 17XD3	SP. 060204	●	17	25	34	129	51	73	56	0.75	18.5				
ATUM 17.5XD3	SP. 060204	●	17.5	25	34	129	51	73	56	0.75	19				
ATUM 18XD3	SP. 060204	●	18	25	34	132	54	76	56	0.5	19				
ATUM 18.5XD3	SP. 060204	●	18.5	25	34	132	54	76	56	0.5	19.5				
ATUM 19XD3	SP. 060204	●	19	25	34	135	57	79	56	0.3	19.6				
ATUM 19.5XD3	SP. 060204	●	19.5	25	34	135	57	79	56	0.3	20.1				
ATUM 20XD3	SP. 060204	●	20	25	34	138	60	82	56	0	20	SP. 07T308	3008-M2.5x6	82-T08	
ATUM 20.5XD3	SP. 060204	●	20.5	25	34	138	60	82	56	0	20.5				
ATUM 21XD3	SP. 060204	●	21	25	34	141	63	85	56	0	21				
ATUM 21.5XD3	SP. 060204	●	21.5	25	34	141	63	85	56	0	21.5				
ATUM 22XD3	SP. 07T308	●	22	25	34	144	66	88	56	1	24				
ATUM 22XD3	SP. 07T308-32	●	22	32	44	153	66	93	60	1	23				
ATUM 22.5XD3	SP. 07T308	●	22.5	25	34	144	66	88	56	1	24.5				
ATUM 23XD3	SP. 07T308	●	23	25	34	147	69	91	56	0.75	24.5				
ATUM 23XD3	SP. 07T308-32	●	23	32	44	156	69	96	60	0.75	24.5				
ATUM 23.5XD3	SP. 07T308	●	23.5	25	34	147	69	91	56	0.75	25				
ATUM 24XD3	SP. 07T308	●	24	25	34	150	72	94	56	0.5	25	SP. 090408	4015-M3.5x9	80-T15	
ATUM 24XD3	SP. 07T308-32	●	24	32	44	159	72	99	60	0.50	25				
ATUM 24.5XD3	SP. 07T308	●	24.5	25	34	150	72	94	56	0.5	25.5				
ATUM 25XD3	SP. 07T308	●	25	25	34	153	75	97	56	0.25	25.5				
ATUM 25XD3	SP. 07T308-32	●	25	32	44	162	75	102	60	0.25	25.5				
ATUM 25.5XD3	SP. 07T308	●	25.5	25	34	153	75	97	56	0.25	26				
ATUM 26XD3	SP. 07T308	●	26	25	34	156	78	100	56	0	26				
ATUM 26XD3	SP. 07T308-32	●	26	32	44	165	78	105	60	0	26				
ATUM 26.5XD3	SP. 07T308	●	26.5	25	34	156	78	100	56	0	26.5				
ATUM 27XD3	SP. 07T308	●	27	25	34	159	81	103	56	0	27				
ATUM 27XD3	SP. 07T308-32	●	27	32	44	168	81	108	60	0	27				
ATUM 27.5XD3	SP. 07T308	●	27.5	25	34	159	81	103	56	0	27.5	SP. 090408	4015-M3.5x9	80-T15	
ATUM 28XD3	SP. 090408	●	28	25	34	162	84	106	56	1	30				
ATUM 28XD3	SP. 090408-32	●	28	32	44	171	84	111	60	1	29				
ATUM 28.5XD3	SP. 090408	●	28.5	25	34	162	84	106	56	1	30.5				
ATUM 29XD3	SP. 090408	●	29	25	34	165	87	109	56	0.75	30.5				
ATUM 29XD3	SP. 090408-32	●	29	32	44	174	87	114	6	0.75	30.5				
ATUM 29.5XD3	SP. 090408	●	29.5	25	34	165	87	109	56	0.75	31				
ATUM 30XD3	SP. 090408	●	30	32	44	177	90	117	60	0.5	31				
ATUM 30.5XD3	SP. 090408	●	30.5	32	44	177	90	117	60	0.5	31.5				
ATUM 31XD3	SP. 090408	●	31	32	44	180	93	120	60	0.25	31.5				
ATUM 31.5XD3	SP. 090408	●	31.5	32	44	180	93	120	60	0.25	32				
ATUM 32XD3	SP. 090408	●	32	32	44	183	96	123	60	0	32				
ATUM 32.5XD3	SP. 090408	●	32.5	32	44	183	96	123	60	0	32.5				
ATUM 33XD3	SP. 090408	●	33	32	44	186	99	126	60	0	33				
ATUM 33.5XD3	SP. 090408	●	33.5	32	44	186	99	126	60	0	33.5				

R: Sağ / Right / Rechts L: Sol / Left / Links

● Stokta / In Stock / Auf Lager ○ Stokta Yok / Non Stock Item / Kein Lagerartikel, Lieferzeit auf Anfrage

TGTC Ucuna Uygundur. / Compatible with TGTC Insert. / Kompatibel mit TGTC Wendeplatten.

Sipariş Örneği/Ordering Example/Bestellbeispiel

1 ad./pcs./stück ATUM 12.5XD3 SP. 050204

Takma Uçlu Matkap Kullanım Kılavuzu : S 375 / User's Guide For U-Drills : P 375

Bedienungsanleitung für Vollbohrer : S 375



Delme Derinliği
Drilling Depth
Bohrtiefe = 3x Çap
= 3x Diameter
= 3x Durchmesser

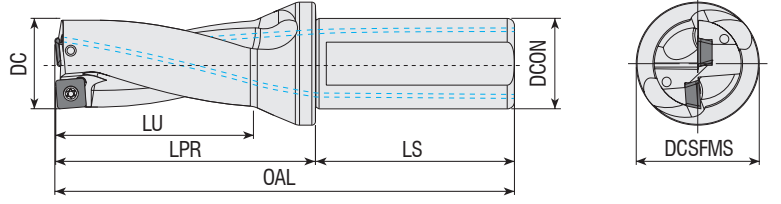

Takım Kodu Ordering Code Bestell-Bezeichnung	Stok Stock Lager	Takım Ölçüleri (mm) Dimension (mm) Abmessung (mm)							Maks. Ofset (radyal) Max. Offset (radial) Max. Versatz (radial)		Kesici Uç Insert Wendeschneidplatte	Yedek Parçaları / Spare Parts / Ersatzteile	
		DC	DCON	DCSFMS	OAL	LU	LPR	LS	X _{max}	DC _{max}		Sıkma Vidası Screw Schraube	Tork Anahtar Torx Key Torx-Schlüssel
ATUM 34XD3 SP. 110408	●	34	32	44	189	102	129	60	1	36	SP. 110408	4015-M4x11	80-T15
ATUM 34.5XD3 SP. 110408	●	34.5	32	44	189	102	129	60	1	36.5			
ATUM 35XD3 SP. 110408	●	35	32	44	192	105	132	60	0.75	36.5			
ATUM 35.5XD3 SP. 110408	●	35.5	32	44	192	105	132	60	0.75	37			
ATUM 36XD3 SP. 110408	●	36	32	44	195	108	135	60	0.6	37.2			
ATUM 36.5XD3 SP. 110408	●	36.5	32	44	195	108	135	60	0.6	37.7			
ATUM 37XD3 SP. 110408	●	37	32	44	198	111	138	60	0.5	38			
ATUM 37.5XD3 SP. 110408	●	37.5	32	44	198	111	138	60	0.5	38.5			
ATUM 38XD3 SP. 110408	●	38	32	44	201	114	141	60	0.25	38.5			
ATUM 38.5XD3 SP. 110408	●	38.5	32	44	201	114	141	60	0.25	39			
ATUM 39XD3 SP. 110408	●	39	32	44	204	117	144	60	0	39			
ATUM 39.5XD3 SP. 110408	●	39.5	32	44	204	117	144	60	0	39.5			
ATUM 40XD3 SP. 110408	●	40	32	44	207	120	147	60	0	40			
ATUM 40.5XD3 SP. 110408	●	40.5	32	44	207	120	147	60	0	40.5			
ATUM 41XD3 SP. 110408	●	41	32	44	210	123	150	60	0	41			
ATUM 41.5XD3 SP. 110408	●	41.5	32	44	210	123	150	60	0	41.5			
ATUM 42XD3 SP. 140512	●	42	32	44	213	126	153	60	1.2	44.4	SP. 140512	1020-M5x11	80-T20
ATUM 42.5XD3 SP. 140512	●	42.5	32	44	213	126	153	60	1.2	44.9			
ATUM 43XD3 SP. 140512	●	43	32	44	216	129	156	60	1	45			
ATUM 43.5XD3 SP. 140512	●	43.5	32	44	216	129	156	60	1	45.5			
ATUM 44XD3 SP. 140512	●	44	32	44	219	132	159	60	0.8	45.6			
ATUM 44.5XD3 SP. 140512	●	44.5	32	44	219	132	159	60	0.8	46.1			
ATUM 45XD3 SP. 140512	●	45	40	54	237	135	167	70	0.6	46.2			
ATUM 45.5XD3 SP. 140512	●	45.5	40	54	237	135	167	70	0.6	46.7			
ATUM 46XD3 SP. 140512	●	46	40	54	240	138	170	70	0.4	46.8			
ATUM 47XD3 SP. 140512	●	47	40	54	243	141	173	70	0.2	47.4			
ATUM 48XD3 SP. 140512	●	48	40	54	246	144	176	70	0	48			
ATUM 49XD3 SP. 140512	●	49	40	54	249	147	179	70	0	49			
ATUM 50XD3 SP. 140512	●	50	40	54	252	150	182	70	0	50			
ATUM 51XD3 SP. 140512	●	51	40	54	255	153	185	70	0	51			
ATUM 52XD3 SP. 140512	●	52	40	54	258	156	188	70	0	52			

R: Sağ / Right / Rechts/ L: Sol / Left / Links
● Stokta / In Stock / Auf Lager ○ Stokta Yok / Non Stock Item / Kein Lagerartikel, Lieferzeit auf Anfrage
TGTC Ucuına Uygundur. / Compatible with TGTC Insert. / Kompatibel mit TGTC Wendeplatten.

Sipariş Örneği/Ordering Example/Bestellbeispiel
1 ad./pcs./stück ATUM 34XD3 SP. 110408
Takma Uçlu Matkap Kullanım Kılavuzu : S 375 / User's Guide For U-Drills : P 375
Bedienungsanleitung für Vollbohrer : S 375



Delme Derinliği
Drilling Depth
Bohrtiefe

= 4x Çap
= 4x Diameter
= 4x Durchmesser

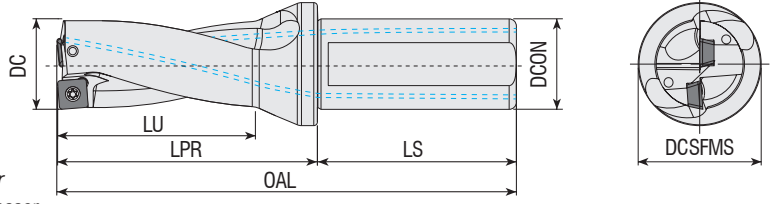

Takım Kodu
Ordering Code
Bestell-Bezeichnung

Stok
Stock
Lager

Takım Ölçüleri (mm)
Dimension (mm)
Abmessung (mm)

Maks. Ofset (radyal)
Max. Offset (radial)
Max. Versatz (radial)

Kesici Uç
Insert
Wendeschnidplatte

Yedek Parçaları / Spare Parts / Ersatzteile

Sıkma Vidası
Screw
Schraube

Tork Anahtar
Torx Key
Torx-Schlüssel

DC DCON DCSFMS OAL LU LPR LS
X_{max} DC_{max}

ATUM	SP.	DC	DCON	DCSFMS	OAL	LU	LPR	LS	X _{max}	DC _{max}	Kesici Uç Insert Wendeschnidplatte	Sıkma Vidası Screw Schraube	Tork Anahtar Torx Key Torx-Schlüssel			
ATUM 13XD4 SP. 050204	●	13	20	25	124	52	74	50	0.75	14.5	SP. 050204	3006-M2x4	82-T06			
ATUM 14XD4 SP. 050204	●	14	20	25	128	56	78	50	0.6	15.2						
ATUM 14.5XD4 SP. 050204	●	14.5	20	25	128	56	78	50	0.60	15.7						
ATUM 15XD4 SP. 050204	●	15	20	25	132	60	82	50	0.5	16	SP. 060204	3007-M2.2x4.6	82-T07			
ATUM 16XD4 SP. 060204	●	16	25	34	142	64	86	56	0.8	17.6						
ATUM 17XD4 SP. 060204	●	17	25	34	146	68	90	56	0.75	18.5						
ATUM 17.5XD4 SP. 060204	●	17.5	25	34	146	68	90	56	0.75	19						
ATUM 18XD4 SP. 060204	●	18	25	34	150	72	94	56	0.5	19						
ATUM 19XD4 SP. 060204	●	19	25	34	154	76	98	56	0.3	19.6						
ATUM 19.5XD4 SP. 060204	●	19.5	25	34	154	76	98	56	0.3	20.1						
ATUM 20XD4 SP. 060204	●	20	25	34	158	80	102	56	0	20						
ATUM 21XD4 SP. 060204	●	21	25	34	162	84	106	56	0	21						
ATUM 22XD4 SP. 07T308	●	22	25	34	166	88	110	56	1	24				SP. 07T308	3008-M2.5x6	82-T08
ATUM 23XD4 SP. 07T308	●	23	25	34	170	92	114	56	0.75	24.5						
ATUM 23.5XD4 SP. 07T308	●	23.5	25	34	170	92	114	56	0.75	25						
ATUM 24XD4 SP. 07T308	●	24	25	34	174	96	118	56	0.5	25						
ATUM 25XD4 SP. 07T308	●	25	25	34	178	100	122	56	0.25	25.5						
ATUM 26XD4 SP. 07T308	●	26	25	34	182	104	126	56	0	26						
ATUM 27XD4 SP. 07T308	●	27	25	34	186	108	130	56	0	27						
ATUM 27.5XD4 SP. 07T308	●	27.5	25	34	186	108	130	56	0	27.5						
ATUM 28XD4 SP. 090408	●	28	25	34	190	112	134	56	1	30	SP. 090408	4015-M3.5x9	80-T15			
ATUM 29XD4 SP. 090408	●	29	25	34	194	116	138	56	0.75	30.5						
ATUM 30XD4 SP. 090408	●	30	32	44	207	120	147	60	0.5	31						
ATUM 31XD4 SP. 090408	●	31	32	44	211	124	151	60	0.25	31.5						
ATUM 32XD4 SP. 090408	●	32	32	44	215	128	155	60	0	32						
ATUM 33XD4 SP. 090408	●	33	32	44	219	132	159	60	0	33						
ATUM 33.5XD4 SP. 090408	●	33.5	32	44	219	132	159	60	0	33.5						
ATUM 34XD4 SP. 110408	●	34	32	44	223	136	163	60	1	36						
ATUM 35XD4 SP. 110408	●	35	32	44	227	140	167	60	0.75	36.5						
ATUM 36XD4 SP. 110408	●	36	32	44	231	144	171	60	0.6	37.2						
ATUM 37XD4 SP. 110408	●	37	32	44	235	148	175	60	0.5	38	SP. 110408	4015-M4x11	80-T15			
ATUM 38XD4 SP. 110408	●	38	32	44	239	152	179	60	0.25	38.5						
ATUM 39XD4 SP. 110408	●	39	32	44	243	156	183	60	0	39						
ATUM 40XD4 SP. 110408	●	40	32	44	247	160	187	60	0	40						
ATUM 41XD4 SP. 110408	●	41	32	44	251	164	191	60	0	41	SP. 140512	1020-M5x11	80-T20			
ATUM 42XD4 SP. 140512	●	42	32	44	255	168	195	60	1.2	44.4						
ATUM 43XD4 SP. 140512	●	43	32	44	259	172	199	60	1	45						
ATUM 44XD4 SP. 140512	●	44	32	44	263	176	203	60	0.8	45.6						
ATUM 46XD4 SP. 140512	●	46	40	54	286	184	216	70	0.40	46.8						

R: Sağ / Right / Rechts/ L: Sol / Left / Links

● Stokta / In Stock / Auf Lager ○ Stokta Yok / Non Stock Item / Kein Lagerartikel, Lieferzeit auf Anfrage
TGTC Ucuna Uygunudur. / Compatible with TGTC Insert. / Kompatibel mit TGTC Wendeplatten.

Sipariş Örneği/Ordering Example/Bestellbeispiel

1 ad./pcs./stück ATUM 13XD4 SP. 050204

Takma Uçlu Matkap Kullanım Kılavuzu : S 375 / User's Guide For U-Drills : P 375

Bedienungsanleitung für Vollbohrer : S 375

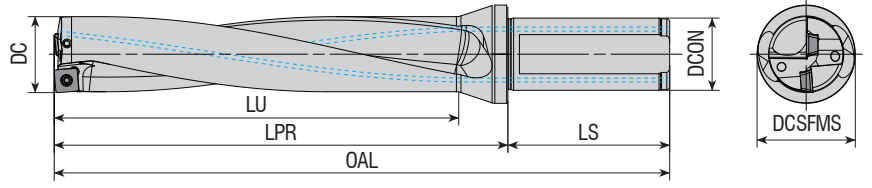

Delme Derinliği
Drilling Depth
Bohrtiefe

= 5x Çap
= 5x Diameter
= 5x Durchmesser

Takım Kodu Ordering Code Bestell-Bezeichnung	Stok Stock Lager	Takım Ölçüleri (mm) Dimension (mm) Abmessung (mm)							Maks. Ofset (radyal) Max. Offset (radial) Max. Versatz (radial)		Kesici Uç Insert Wendeschneldplatte	Yedek Parçaları / Spare Parts / Ersatzteile	
		DC	DCON	DCSFMS	OAL	LU	LPR	LS	X _{max}	DC _{max} [mm]		Sıkma Vidası Screw Schraube	Tork Anahtar Torx Key Torx-Schlüssel
ATUM 13XD5 SP. 050204	●	13	20	25	137	65	87	50	0.75	14.5	SP. 050204	3006-M2.5x4	82-T06
ATUM 14XD5 SP. 050204	●	14	20	25	142	70	92	50	0.6	15.2			
ATUM 14.5XD5 SP. 050204	●	14.5	20	25	142	70	92	50	0.60	15.7			
ATUM 15XD5 SP. 050204	●	15	20	25	147	75	97	50	0.50	16			
ATUM 16XD5 SP. 060204	●	16	25	34	158	80	102	56	0.8	17.6	SP. 060204	3007-M2.2x4.6	82-T07
ATUM 17XD5 SP. 060204	●	17	25	34	163	85	107	56	0.75	18.5			
ATUM 17XD5 SP. 060204-32	●	17	32	34	163	85	107	56	0.75	18.5			
ATUM 18XD5 SP. 060204	●	18	25	34	168	90	112	56	0.5	19			
ATUM 19XD5 SP. 060204	●	19	25	34	173	95	117	56	0.3	19.6			
ATUM 20XD5 SP. 060204	●	20	25	34	178	100	122	56	0	20			
ATUM 21XD5 SP. 060204	●	21	25	34	183	105	127	56	0	21			
ATUM 22XD5 SP. 07T308	●	22	25	34	188	110	132	56	1	24			
ATUM 22XD5 SP. 07T308-32	●	22	32	44	197	110	137	60	1	24	SP. 07T308	3008-M2.5x6	82-T08
ATUM 23XD5 SP. 07T308	●	23	25	34	193	115	137	56	0.75	24.5			
ATUM 23XD5 SP. 07T308-32	●	23	32	44	202	115	142	60	0.75	24.5			
ATUM 24XD5 SP. 07T308-32	●	24	32	44	207	120	147	60	0.5	25			
ATUM 25XD5 SP. 07T308	●	25	25	34	203	125	147	56	0.25	25.5			
ATUM 25XD5 SP. 07T308-32	●	25	32	44	212	125	152	60	0.25	25.5			
ATUM 26XD5 SP. 07T308	●	26	25	34	208	130	152	56	0	26			
ATUM 26XD5 SP. 07T308-32	●	26	32	44	217	130	157	60	0	26			
ATUM 27XD5 SP. 07T308	●	27	25	34	213	135	157	56	0	27			
ATUM 27XD5 SP. 07T308-32	●	27	32	44	222	135	162	60	0	27			
ATUM 28XD5 SP. 090408-32	●	28	32	44	227	140	167	60	1	30	SP. 090408	4015-M3.5x9	80-T15
ATUM 29XD5 SP. 090408-32	●	29	32	44	232	145	172	60	0.75	30.5			
ATUM 30XD5 SP. 090408	●	30	32	44	237	150	177	60	0.5	31			
ATUM 31XD5 SP. 090408	●	31	32	44	242	155	182	60	0.25	31.5			
ATUM 32XD5 SP. 090408	●	32	32	44	247	160	187	60	0	32			
ATUM 33XD5 SP. 090408	●	33	32	44	252	165	192	60	0	33			

R: Sağ / Right / Rechts L: Sol / Left / Links

● Stokta / In Stock / Auf Lager ○ Stokta Yok / Non Stock Item / Kein Lagerartikel, Lieferzeit auf Anfrage
TGTC Ucuna Uygundur. / Compatible with TGTC Insert. / Kompatibel mit TGTC Wendeplatten.

Sipariş Örneği/Ordering Example/Bestellbeispiel

1 ad./pcs./stück ATUM 13XD5 SP. 050204

Takma Uçlu Matkap Kullanım Kılavuzu : S 375 / User's Guide For U-Drills : P 375

Bedienungsanleitung für Vollbohrer : S 375

HELİSEL İÇTEN SU VERME KANALLI MATKAPLAR

INDEXABLE DRILLS WITH HELICAL COOLANT HOLE

INDIZIERBARE VOLLBOHRER MIT HELIX KÜHLUNGSHÖHLEN

Farklı çaplarda ve ALFA KAPLAMA teknolojisini ile siparişe hazır.

They are ready to order in different diameters and with ALPHA COATING technology.

Die Vollbohrer sind in unterschiedlichen Dimensionen und mit ALFABESCHICHTUNGSTECHNOLOGIE bereit für die Bestellungen.

- Helisel içten su verme kanallı
- Üstün Alpha Kaplama Teknolojisi
- 1000 Vickers'e dayanan yüksek yüzey sertliği
- Aşınmaya karşı yüksek direnç
- Dengeli ve hassas kesim
- Helical Internal Coolant Holes
- Superior Alpha Coating Technology
- High surface hardness up to 1000 Vickers
- High resistance to abrasion
- Balanced and precise cutting
- Helix innterne Kühlungshöhlen
- Überragende Alphabeschichtungsstechnologie
- Hohe Oberflächen Härte bis zu 1000 Vickers.
- Hoher Widerstand gegen Abnutzung
- Ausgewogene und präzise Bearbeitung

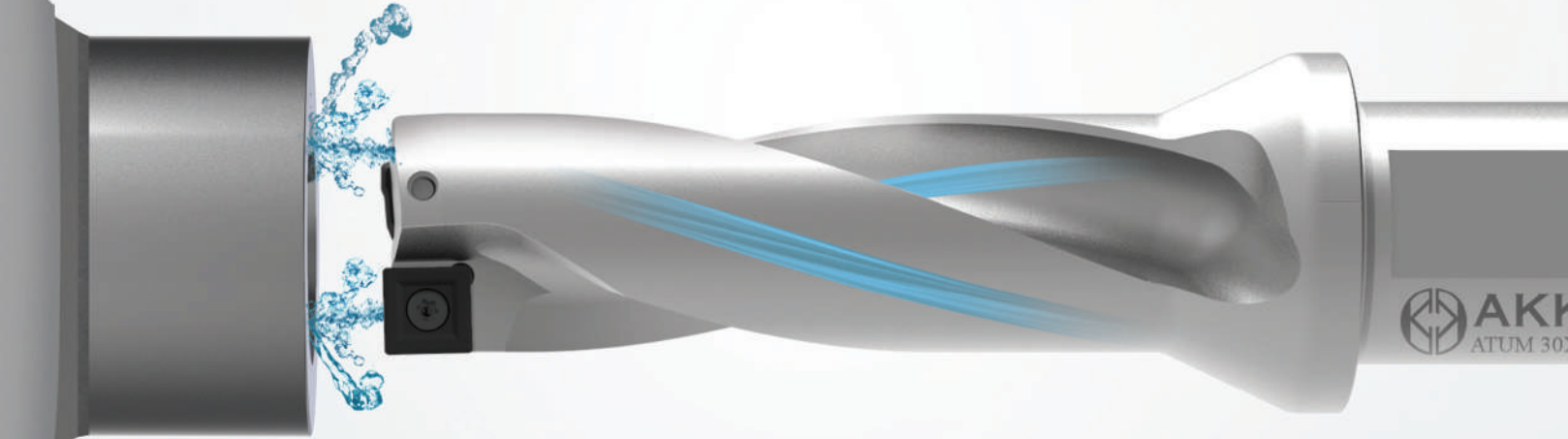

AKKO HELİSEL KANAL TEKNOLOJİSİ
AKKO HELICAL CHANNEL TECHNOLOGY
AKKO HELIX KANAL TECHNOLOGIE

RAKİPLER
COMPETITORS
KONKURRENZ

* STOK DURUMU / STOCK STATUS / STOCK STATUS

D2 / D3 / D4 / D5

* Helisel İçten Su Verme Kanallı
Twisted Coolant Hole
Spiralförmige Kühlungshöhlen



KESME & KANAL AÇMA UÇ VE TAKIMLARI

GROOVING & PARTING INSERT AND TOOLS
EINSTECH- UND ABSTECHWENDESCHNEIDPLATTEN
UND WERKZEUGE

AGD-MT / AGD-MR Uç Serisi / Insert Series / Insert Serie



Kesme ve Kanal Açma Uçlarına Genel Bakış

Overview of Parting and Grooving Inserts

Überblick über Wendeschneidplatten zum Abstechen und Einstechen

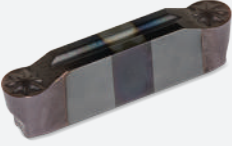
Form Shape	Geometri Geometry	Ugulama Application	Genişlik Width
	AGD-MT	Medium Turning	2.0-8.0 (mm)
	AGD-MR	Medium Profiling	2.0-8.0 (mm)

Önerilen Kesme Değerleri Recommended Cutting Datas Empfohlene Schnittdaten

AGD-MT

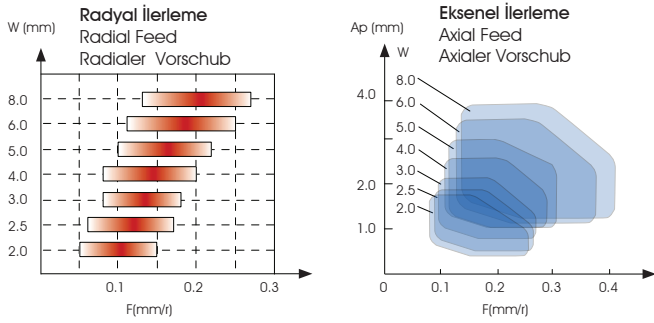

AGD-MR

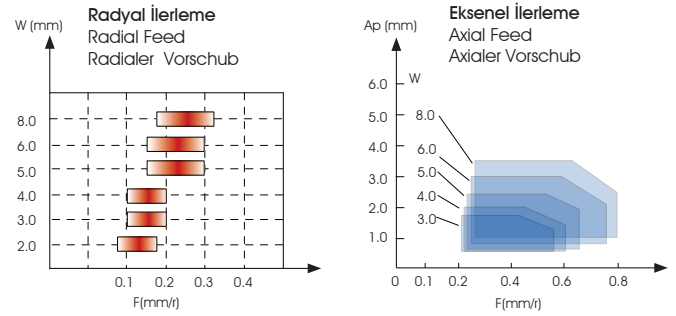

ISO	İs Parçası Malzemesi Workpiece Material	Sertlik Hardness (HB)	Kesme Hızı / Cutting Speed Vc m/min / Schneidgeschwindigkeit						
			AP1105	AP1225	AK1115	AS3115	AS3125	AA4230	AS9125
P	Düşük Karbonlu Çelik Low Carbon Steel	80 – 170	120 (80-220)	120 (80-220)		70 (50-100)	70 (50-100)	110 (70-180)	
	Yüksek Karbonlu Çelik High Carbon Steel	170 – 250	120 (80-220)	120 (80-220)				110 (70-150)	
	Düşük Alaşımli Çelik Low-alloy Steel	140– 260	110 (60-180)	110 (60-180)		70 (50-100)	70 (50-100)	(40-150)	
	Yüksek Alaşımli Çelik High-alloy Steel	180– 300	110 (60-180)	110 (60-180)				110 (40-150)	
	Dökme Çelik Cast Steel	180– 300	110 (60-180)	110 (60-180)				110 (40-150)	
M	Feritik / Martenzitik Ferritic / Martensitic	150– 270				90 (50-150)	90 (30-180)	110 (40-180)	
	Östenitik Austenitic	150– 270				90 (50-150)	90 (30-180)	(40-180)	
K	Dövülebilir Dökme Demir Malleable Cast Iron	150– 230			130 (50-200)			(50-180)	
	Grü Dökme Demir Gray Cast Iron	150– 230			130 (50-200)			110 (50-180)	
	Sferö Döküm Demir Nodular Cast Iron	160– 260			100 (50-150)			100 (50-150)	
S	Isıya Dayanıklı Alaşımlar Heat-resistant Alloy	130– 400				35 (15-60)	35 (15-70)		
	Titanyum Alaşımlar Titanium Alloys	130– 400				35 (15-60)	35 (15-70)		35 (15-60)

1	2	3	4-5	6-7	8	9	10
A	G	D	30--04	MT	A	A	4230
AKKO	GROOVING KANAL AÇMA	D DOUBLE SIDE ÇİFT TARAFLI S SINGLE SIDE TEK TARAFLI	WIDTH GENİŞLİK CORNER RADIUS KÖŞE YARIÇAPI	CHIP BREAKER TALAŞ KIRICI FORM MT: MEDIUM TURNING MT: ORTA TORNALAMA MR: MEDIUM PROFILING MR: ORTA PROFİLLEME	AKKO	A: GENERAL / GENEL P: STEEL / ÇELİK K: CAST IRON / DÖKÜM M: STAINLESS STEEL / PASLANMAZ S: HEAT RESISTANT ALLOYS / TITANIUM ISIYA DAYANIKLI ALAŞIMLAR / TİTANYUM N: NON-FERROUS METARIALS DEMİR OLMAYAN METALLER H: HARDENED STEEL / SERT METAL	GRADE / SERTLİK

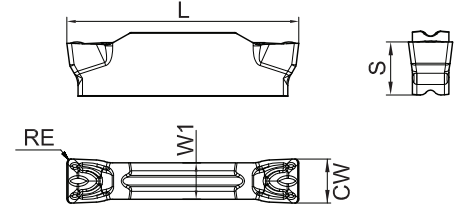

AGD-MT

AKKO Çift Taraflı Kesme Uçları
 AKKO Grooving Double Side
 AKKO Nuten beidseitig



Sipariş Kodu Ordering Code Bestellungsnummer	Ölçü / Dimension (mm) / Dimension					Kalite / Grade / Qualität		
	CW±0.05	RE±0.05	L	W1	S	AP1225	AK1115	AA4230
AGD2002-MT	2.0	0.2	16.0	1.2	3.5	●	●	●
AGD2502-MT	2.5	0.2	18.5	2.0	3.85	●	●	●
AGD3004-MT	3.0	0.4	21.2	2.35	4.8	●	●	●
AGD4004-MT	4.0	0.4	21.0	3.3	4.8	●	●	●
AGD5004-MT	5.0	0.4	26.0	4.1	5.8	●	●	●
AGD5008-MT	5.0	0.8	26.0	4.1	5.8	●	●	●
AGD6004-MT	6.0	0.4	26.0	5.0	5.8	●	●	●
AGD6008-MT	6.0	0.8	26.0	5.0	5.8	●	●	●
AGD8008-MT	8.0	0.8	31.0	6.0	6.5	●	●	●

● Stok Stock ○ Talep Edilmesi Halinde Üretilecek Available upon order

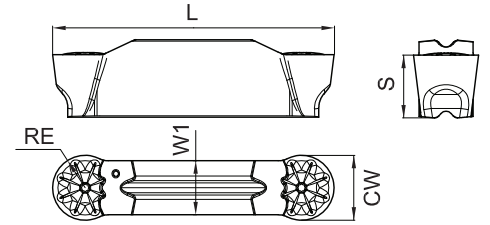

AGD-MR

AKKO Çift Taraflı Kesme Uçları
 AKKO Grooving Double Side
 AKKO Nuten beidseitig



Sipariş Kodu Ordering Code Bestellungsnummer	Ölçü / Dimension (mm) / Dimension					Kalite / Grade / Qualität			
	CW±0.05	RE±0.05	L	W1	S	AP1105	AP1225	AK1115	AA4230
AGD2010-MR	2.0	1.0	16.0	1.2	3.5	●	●	●	●
AGD3015-MR	3.0	1.5	21.2	2.35	4.8	●	●	●	●
AGD4020-MR	4.0	2.0	21.0	3.3	4.8	●	●	●	●
AGD5025-MR	5.0	2.5	26.0	4.1	5.8	●	●	●	●
AGD6030-MR	6.0	3.0	26.0	5.0	5.8	●	●	●	●
AGD8040-MR	8.0	4.0	31.0	6.0	6.5	●	●	●	●

● Stok Stock ○ Talep Edilmesi Halinde Üretilecek Available upon order

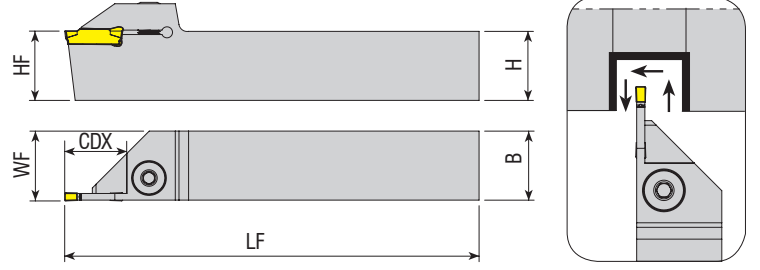

Takım Kodu Ordering Code Bestell-Bezeichnung	Stok Stock		Takım Ölçüleri (mm) Dimension (mm)				Kesici Uç Insert	Yedek Parçaları / Spare Parts			
	R	L	HF=H	B	LF	WF		CDX	Sıkma Vidası Screw	Pul Stamp	Anahtar Allen Key
ADKT-K-R/L-1212-1.5-T15	●	●	12	12	100	12.2	15	MGM. - 1.5	AKV-02-M6x22	ABPL-01	AAL-03-3
ADKT-K-R/L-2020-1.5-T15	●	●	20	20	125	20.2	15				
ADKT-K-R/L-1212-2-T15	●	●	12	12	100	16.3	15	AGD. - 2 MGM. - 2	AKV-02-M6x22	ABPL-01	AAL-03-3
ADKT-K-R/L-1616-2-T10	●	●	16	16	125	16.3	10				
ADKT-K-R/L-1616-2-T15	●	●	16	16	125	16.3	15				
ADKT-K-R/L-2020-2-T15	●	●	20	20	150	20.3	15				
ADKT-K-R/L-2525-2-T15	●	●	25	25	150	25.3	15				
ADKT-K-R/L-3232-2-T15	●	●	32	32	170	32.3	15				
ADKT-K-R/L-1212-3-T15	●	●	12	12	100	12.3	15	AGD. - 3 MGM. - 3			
ADKT-K-R/L-1616-3-T15	●	●	16	16	125	16.3	15				
ADKT-K-R/L-2020-3-T10	●	●	20	20	125	20.3	10				
ADKT-K-R/L-2020-3-T20	●	●	20	20	125	20.3	20				
ADKT-K-R/L-2020-3-R28	●	●	20	20	125	20.3	28				
ADKT-K-R/L-2525-3-T10	●	●	25	25	150	25.3	10				
ADKT-K-R/L-2525-3-R15	●	●	25	25	150	25.3	15				
ADKT-K-R/L-2525-3-T22	●	●	25	25	150	25.3	22				
ADKT-K-R/L-3232-3-T10	●	●	32	32	170	32.3	10				
ADKT-K-R/L-3232-3-T22	●	●	32	32	170	32.3	22				
ADKT-K-R/L-2020-4-T10	●	●	20	20	125	20.4	10	AGD. - 4 MGM. - 4	2004-M8x1x20	-	AAL-05-4
ADKT-K-R/L-2020-4-T20	●	●	20	20	125	20.4	20				
ADKT-K-R/L-2020-4-R25	●	○	20	20	125	20.4	25				
ADKT-K-R/L-2525-4-T10	●	●	25	25	150	25.4	10				
ADKT-K-R/L-2525-4-T18	●	●	25	25	150	25.4	18				
ADKT-K-R/L-2525-4-T22	●	●	25	25	150	25.4	22				
ADKT-K-R/L-3232-4-T10	●	●	32	32	170	32.4	10	AGD. - 5 MGM. - 5			
ADKT-K-R/L-3232-4-T22	●	●	32	32	170	32.4	22				
ADKT-K-R/L-2020-5-T20	●	●	20	20	125	20.5	20				
ADKT-K-R/L-2525-5-T15	●	●	25	25	150	25.5	15				
ADKT-K-R/L-2525-5-T18	●	●	25	25	150	25.5	18				
ADKT-K-R/L-2525-5-T25	●	●	25	25	150	25.5	25				
ADKT-K-R/L-3232-5-T15	●	●	32	32	170	32.5	15	AGD. - 6 MGM. - 6			
ADKT-K-R/L-3232-5-T25	●	●	32	32	170	32.5	25				
ADKT-K-R/L-2525-6-T15	●	●	25	25	150	25.6	15				
ADKT-K-R/L-2525-6-T25	●	●	25	25	150	25.6	25	AGD. - 8 / MGM. - 8			
ADKT-K-R/L-3232-6-T25	●	●	32	32	170	32.6	25				
ADKT-K-R/L-3232-8-T32	●	●	32	32	170	32.8	32				

R: Sağ / Right L: Sol / Left

● Stokta / In Stock ○ Stokta Yok / Non Stock Item

Sipariş Örneği/Ordering Example/Bestellbeispiel
1 ad./pcs. /stück ADKT-K-R-1212-1.5-T15

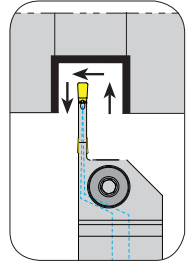
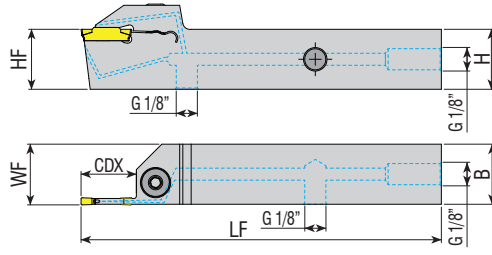

Takım Kodu Ordering Code Bestell-Bezeichnung	Stok Stock		Takım Ölçüleri (mm) Dimension (mm)				Kesici Uç Insert	Yedek Parçaları / Spare Parts			
	R	L	HF=H	B	LF	WF		CDX	Sıkma Vidası Screw	Pul Stamp	Anahtar Allen Key
ADKT-K-R/L-2020-3-T20-H	●	●	20	20	125	20.4	20	AGD. - 3 MGM. - 3			
ADKT-K-R/L-2525-3-T22-H	●	●	25	25	150	25.4	22				
ADKT-K-R/L-2020-4-T20-H	●	●	20	20	125	20.4	20	AGD. - 4 MGM. - 4	2004-M8x1x20	-	AAL-05-4
ADKT-K-R/L-2525-4-T22-H	●	●	25	25	150	25.4	22				
ADKT-K-R/L-2525-5-T25-H	●	●	25	25	150	25.5	25	AGD. - 5 / MGM. - 5			

➤ **DIŞ ÇAP KANAL AÇMA İSVİÇRE TİPİ KAYAR OTOMAT MAKİNA TAKIMLARI**
EXTERNAL GROOVING TOOLHOLDERS FOR SWISS TYPE SLIDING AUTOMATIC LATHES
WERKZEUGE ZUR STECHBEARBEITUNG AUF LANGDREHAUTOMATEN

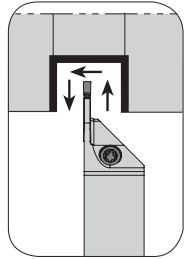
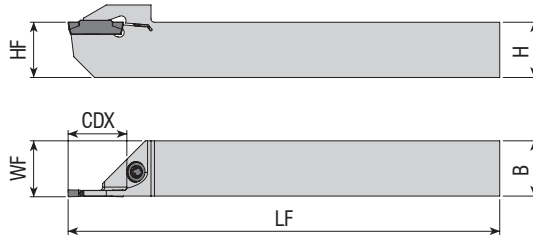

Takım Kodu Ordering Code Bestell-Bezeichnung	Stok Stock		Takım Ölçüleri (mm) Dimension (mm)				Kesici Uç Insert	Yedek Parçaları / Spare Parts			
	R	L	HF=H	B	LF	WF		CDX	Sıkma Vidası Screw	Pul Stamp	Anahtar Allen Key
ADKT-K-R/L-1212-2-R12-K-S	●	●	12	12	125	12.20	12	AGD. - 2 MGM. - 2	4015-M4x11	-	
ADKT-K-R/L-1616-2-R16-K-S	●	●	16	16	125	16.20	16				
ADKT-K-R/L-1212-3-R12-K-S	●	●	12	12	125	12.30	12	AGD. - 3 MGM. - 3			
ADKT-K-R/L-1616-3-R16-K-S	●	●	16	16	125	16.30	16				

Sipariş Örneği/Ordering Example/Bestellbeispiel
1 ad./pcs./stück ADKT-K-R/L-2020-3-T20-H

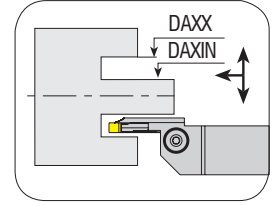
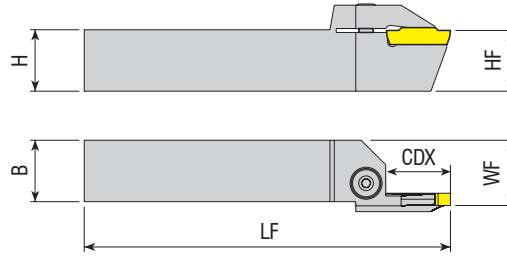

Takım Kodu Ordering Code Bestell-Bezeichnung	Stok Stock		Takım Ölçüleri (mm) Dimension (mm)							Kesici Uç Insert	Yedek Parçaları / Spare Parts		
	R	L	HF=H	B	LF	WF	CDX	DAXIN	DAXX		Sıkma Vidası Screw	Pul Stamp	Anahtar Allen Key
AAKT-K-R/L-2525-34-45-3-T17	●	●	25	25	150	26.5	17	34	45	AGD. - 3 MGM. - 3			
AAKT-K-R/L-2525-39-55-3-T17	●	●	25	25	150	26.5	17	39	55				
AAKT-K-R/L-2525-49-80-3-T17	●	●	25	25	150	26.5	17	49	80				
AAKT-K-R/L-2525-70-110-3-T17	●	●	25	25	150	26.5	17	70	110				
AAKT-K-R/L-2525-100-150-3-T17	●	●	25	25	150	26.5	17	100	150				
AAKT-K-R/L-2525-80-180-3-T32	●	●	25	25	150	26.5	32	80	180				
AAKT-K-R/L-2525-175-215-3-T22	●	●	25	25	150	26.5	22	175	215				
AAKT-K-R/L-2525-700-800-3-T17	●	●	25	25	150	26.5	17	700	800				
AAKT-K-R/L-2525-50-85-4-T22	●	●	25	25	150	26.5	22	50	85	AGD. - 4 MGM. - 4	2004-M8x1x20	-	AAL-05-4
AAKT-K-R/L-2525-70-110-4-T22	●	●	25	25	150	26.5	22	70	110				
AAKT-K-R/L-2525-100-150-4-T22	●	●	25	25	150	26.5	22	100	150				
AAKT-K-R/L-2525-80-180-4-T32	●	●	25	25	150	26.5	32	80	180				
AAKT-K-R/L-2525-180-800-4-T32	●	●	25	25	150	26.5	32	180	800				
AAKT-K-R/L-2525-70-110-5-T25	●	●	25	25	150	26.5	25	70	110	AGD. - 5 MGM. - 5			
AAKT-K-R/L-2525-100-150-5-T25	●	●	25	25	150	26.5	25	100	150				
AAKT-K-R/L-2525-80-180-5-T32	●	●	25	25	150	26.5	32	80	180				
AAKT-K-R/L-2525-140-200-5-T25	●	●	25	25	150	26.5	25	140	200				
AAKT-K-R/L-2525-180-800-5-T32	●	●	25	25	150	26.5	32	180	800				
AAKT-K-R/L-2525-60-100-6-T25	●	●	25	25	150	26.5	25	60	100	AGD. - 6 MGM. - 6			
AAKT-K-R/L-2525-60-100-6-T35	●	○	25	25	150	26.5	35	60	100				
AAKT-K-R/L-2525-100-200-6-T25	●	○	25	25	150	26.5	25	100	200				
AAKT-K-R/L-2525-100-200-6-T35	●	○	25	25	150	26.5	35	100	200				
AAKT-K-R/L-2525-100-200-6-T45	●	○	25	25	150	26.5	45	100	200				
AAKT-K-R/L-2525-140-300-6-T35	●	●	25	25	150	26.5	35	140	300				
AAKT-K-R/L-2525-140-300-8-T35	●	○	25	25	150	26.5	35	140	300	AGD. - 8 MGM. - 8			
AAKT-K-R/L-3232-140-350-8-T35	●	○	32	32	150	33.5	35	140	350				

R: Sağ / Right L: Sol / Left
● Stokta / In Stock ○ Stokta Yok / Non Stock Item

Sipariş Örneği/Ordering Example/Bestellbeispiel
1 ad./pcs./stück AAKT-K-R-2525-34-45-3-T17

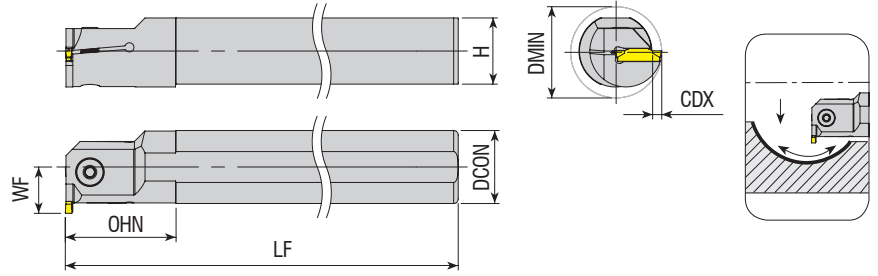

Takım Kodu Ordering Code Bestell-Bezeichnung	Stok Stock		Takım Ölçüleri (mm) Dimension (mm)							Kesici Uç Insert	Yedek Parçaları / Spare Parts	
	R	L	DCON	DMIN	LF	OHN	CDX	H	WF		Sıkma Vidası Screw	Anahtar Allen Key
AIKT-K-R/L-16-2-T4	●	●	16	21	150	28	4	14.8	12	AGD. - 2 MGM. - 2	2503-M4x10	AAL-03-3
AIKT-K-R/L-20-2-T4	●	●	20	25	170	30	4	18.3	14		2503-M4x12	
AIKT-K-R/L-25-2-T6	●	●	25	32	200	40	6	23	18.5		2504-M5x12	
AIKT-K-R/L-20-3-T6	●	●	20	27	170	30	6	18.3	16	AGD. - 3 MGM. - 3	2504-M5x12	
AIKT-K-R/L-20-3-T7	●	●	20	25	170	38	7	18.3	13			
AIKT-K-R/L-25-3-T6	●	●	25	32	200	40	6	23	18.5			
AIKT-K-R/L-25-3-T10	●	●	25	32	200	48	10	23	17		2504-M5x16	
AIKT-K-R/L-32-3-T6	●	●	32	39	250	50	6	30	22			
AIKT-K-R/L-32-3-T12	●	●	32	39	250	53	12	30	22			
AIKT-K-R/L-40-3-T6	●	●	40	47	300	55	6	37.5	26		2004-M8x1x20	
AIKT-K-R/L-40-3-T12	●	○	40	48	300	63	12	37.5	27			
AIKT-K-R/L-20-4-T6	●	●	20	27	170	30	6	18.3	16			
AIKT-K-R/L-20-4-T7	●	○	20	25	170	38	7	18.3	13		2504-M5x12	
AIKT-K-R/L-25-4-T6	●	●	25	32	200	40	6	23	18.5			
AIKT-K-R/L-25-4-T10	●	●	25	32	200	49	10	23	17	2504-M5x16		
AIKT-K-R/L-32-4-T6	●	●	32	39	250	50	6	30	22			
AIKT-K-R/L-32-4-T12	●	●	32	39	250	53	12	30	22			
AIKT-K-R/L-40-4-T6	●	●	40	47	300	55	6	37.5	26	2004-M8x1x20		
AIKT-K-R/L-40-4-T12	●	●	40	48	300	63	12	37.5	27			
AIKT-K-R/L-25-5-T7	●	●	25	33	200	40	7	23	19.5	2504-M5x16	AGD. - 5 MGM. - 5	
AIKT-K-R/L-32-5-T7	●	●	32	40	250	50	7	30	23			
AIKT-K-R/L-40-5-T7	●	●	40	48	300	55	7	37.5	27	2004-M8x1x20		
AIKT-K-R/L-40-5-T12	●	○	40	48	300	63	12	37.5	27			

R: Sağ / Right L: Sol / Left
● Stokta / In Stock ○ Stokta Yok / Non Stock Item

Sipariş Örneği/Ordering Example/Bestellbeispiel
1 ad./pcs./stück. AIKT-K-R-16-2-T4

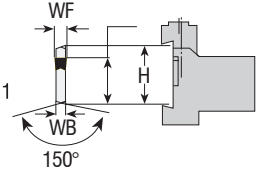
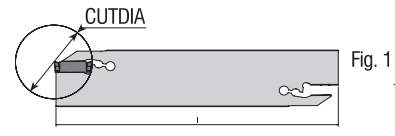
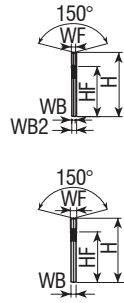

Takım Kodu Ordering Code Bestell-Bezeichnung	Stok Stock	Takım Ölçüleri (mm) Dimension (mm)							Kesici Uç Insert	Yedek Parçaları / Spare Parts	
		H	WF	WB2	WB	I	HF	CUTDIA		Anahtar Allen Key	
AKL-K-32-2	●	32	2	2.4	1.6	150	25	32	AGD. - 2 / MGM. - 2	ALA-02	
AKL-K-32-3	●	32	3	2.4	-	150	25	42	AGD. - 3 / MGM. - 3		
AKL-K-32-4	●	32	4	3.2	-	150	25	42	AGD. - 4 / MGM. - 4		



BARALAR

AYARLI DELİK İŞLEME BARALARI
ADJUSTABLE BORING HEADS
EINSTELLBARE SPINDELKÖPFE

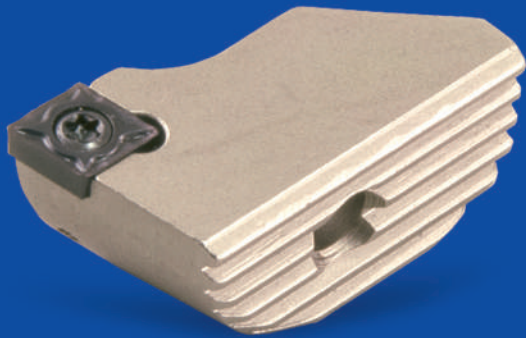



AKKO **A** **BH** **R** - **D18x22**

W16 - **L90** - **CC06**

2 Kesiş Stili / Cutter Style / Werkzeugtyp

BH : Delik İşleme / Boring Head
Spindelkopf

3 İşlem Tipi / Cutter Type / Einsatzgebiet

R : Kaba Baralama / Rough Boring
Schruppbearbeitung
F : Hassas Baralama / Fine Boring
Schlichtbearbeitung

5 Montaj Formu / Assembly Form / Schaftform

W : Weldon

4 Ölçü Aralığı / Boring Range / Bohrbereich

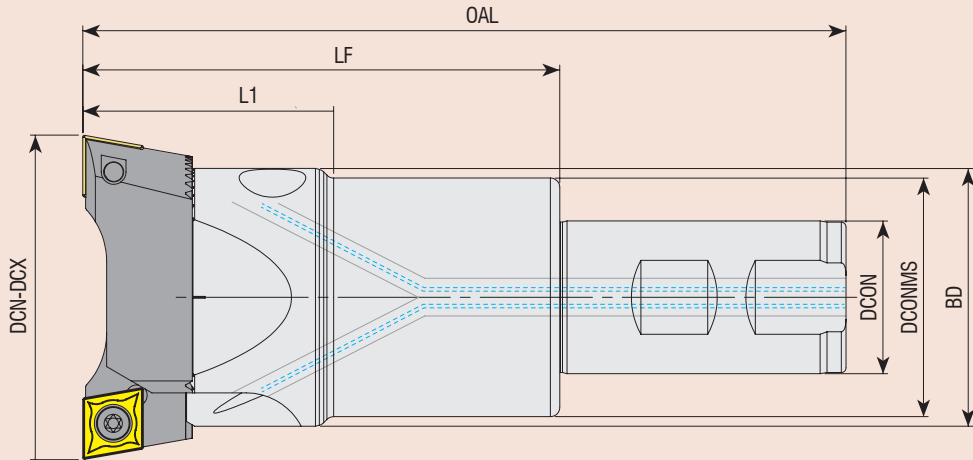

6 Takım Boyu / Tool Length / Werkzeuglänge

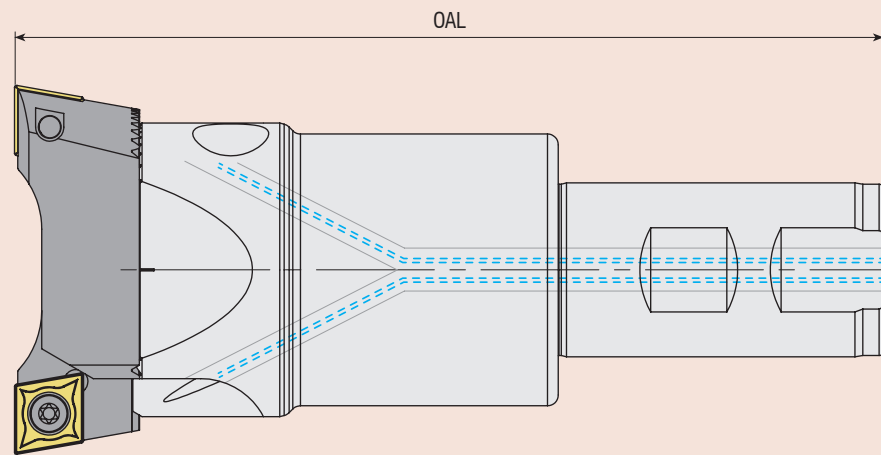

7 Kesici Uç / Insert / Wendeschneidplatte

CC06 : CC.. 0602..
CC09 : CC.. 09T3..
CC12 : CC.. 1204..

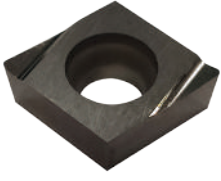

EDP	DESCRIPTION / AÇIKLAMA	CUTTING SPEED Vc=m/min KESME HIZI	FEED fn=mm/rev İLERLEME
T.01.08.03.01	CCGT 09T302L-AC1020	100-200	0.15~0.3
T.01.08.03.02	CCGT 09T304L-AC1020	100-200	0.2~0.4



EDP	DESCRIPTION / AÇIKLAMA	CUTTING SPEED Vc=m/min KESME HIZI	FEED fn=mm/rev İLERLEME
T.01.08.03.01	TPGH 09T0202L-AC1020	100-200	0.15~0.3
T.01.08.03.02	TPGH 09T0204L-AC1020	100-200	0.2~0.4

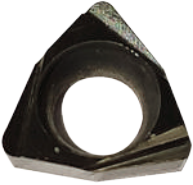

EDP	DESCRIPTION / AÇIKLAMA	CUTTING SPEED Vc=m/min KESME HIZI	FEED fn=mm/rev İLERLEME
T.01.08.03.01	WCGT 020102L-AC1020	100-200	0.05~0.2
T.01.08.03.02	WCGT 020104L-AC1020	100-200	0.08~0.3





AKKO®

konusulan
the spoken kalite...
quality...

www.akkco.com.tr



**KONUŞULAN
KALİTE**

**THE SPOKEN
QUALITY**



VERSİYON
VERSION
AUFLAGE **0100/0924**
TR / EN / DEU

 **AKKO**[®]
MAKİNA SANAYİ VE TİCARET A.Ş.

Konya 5. Organize Sanayi Bölgesi
Aşağıpınarbaşı Osb Mh. 526 Nolu Sk. No:1
Selçuklu / KONYA / TÜRKİYE

Tel : +90 332 239 17 57 (pbx)
Fax : +90 332 239 17 52
GPS : 38.005409, 32.635734

www.akko.com.tr
akko@akko.com.tr
export@akko.com.tr



    AKKO Metalworking Tools

Yenilikler için bizi takip ediniz!
Follow us for news!
Für Neuheiten bitte uns folgen!